

more value for your money

PROMOTION

TOPS



SHOP
THE
TOPS

2016

PREMIUM INSIDE >



004 SERVICE & QUALITY

„I guarantee you best service and top quality.“

- 004 Additional value with brands and product safety
- 006 Printing service
- 008 Printing specials: 360° engraving, direct printing and XXL printing
- 010 Packages



014 OFFICE & BUSINESS

„My office is in top shape.“

- 015 Writing utensils
- 036 Portfolios and briefcases
- 048 Everything to remind you
- 058 Office supplies and business card holders
- 068 Calculators
- 072 Computer equipment
- 076 Cell- and smartphone accessories



082 MUSIC & TIME

„Everything for the right rhythm of life.“

- 083 Radios and loudspeakers
- 087 Headphones
- 089 Clocks and weather stations



102 LIGHTS & TOOLS

„Here you can find small helpers for big things in life.“

- 103 Lamps and torches
- 111 Safety, car accessories and first aid
- 124 Tools and measuring tapes



136 SAVE & PRACTICAL

„Everything here is practically top-notch.“

- 137 Key rings and wristbands
- 154 Wallets and money boxes



158 HOME & LIVING

„We love convivial gatherings with our friends.“

- 159 Household and kitchen accessories
- 184 Wine and bar utensils
- 196 Double-walled flasks and mugs
- 202 Lighters and candles
- 212 Wellness and fitness
- 220 Cosmetic accessories and manicure sets
- 228 Useful for a journey





234 TRAVEL & HOLIDAY

„I am where the action is.“

235 Bags, suitcases, beauty cases
and rucksacks

288 Cooler bags



290 SUN & RAIN

„I make the right choice
no matter the weather.“

291 Umbrellas

314 Parasols



316 LEISURE & FUN

„How cool is that?“

317 Garden items

322 Camping

324 Pocket knives

328 Barbecue and picnic

338 Clothing, caps and hats

345 Bicycle accessories

350 All for outdoor games, sport
and beach

372 Games and antistress items

384 Arts and crafts

393 Plush toys



WELCOME

A warm welcome! We wish you lots of fun while browsing the following pages.

The variety is large!

You can find the perfect promotional item for every occasion in our range, sharp knives, entertaining timers, indescribable lovely office supplies, wonderful travel companions, practical key rings and fantastic leisure items.

What does one need more?

Are you ready for a PromotionTops 2016 shopping spree? Then it's time to

**SHOP
THE
TOPS
2016**



403 PiCOWORLD INSIDE





To protect the safety of our customers, our products undergo a risk assessment regarding the substances of high concern as specified by the EU REACH regulation. DEKRA supports us in the risk assessment, and the internationally recognized DEKRA certification mark stands for credibility and security that our customers can trust.

THE SAFETY OF A PRODUCT IS VERY IMPORTANT TO US.

It begins with the quality of the product and stretches over the production process, which respects and complies with the social and environmental standards. All items in our catalogues have been tested from A to Z. Worldwide-recognized certificates ensure the conformity of our products and are key to the market. Strict controls and constant improvements form the basis of the product safety, which guarantees the best quality for our customers.

DO THE CHECK YOURSELF:

- RoHS
- CE
- WEEE
- REACH
- EN471
- EN13356
- EN71
- EMC/EMV
- LFGB
- Nickel-free
- Cadmium-free
- Phthalate-free
- AZO free

BATTERY 56-0499129

Micro 1,5 V
(AAA/LR03/AM4)
60/1200 pieces



BATTERY 56-0499128

Mignon 1,5 V
(AA/LR6/AM3)
60/600 pieces



SAFETY WITH STRONG BRANDS:

Our brands stand for creativity and innovation - lifestyle products with a high recognition value developed by own designers. Our brands promise quality at moderate prices. They serve as guidelines and facilitate the purchase decision. Our brands combine products from different categories: office, clothing, wellness, luggage and weather protection.



Exclusive clothing line



Exclusive brand for design umbrellas as well as office supplies



Exclusive wellness line with products for beauty, fitness and health



Exclusively developed and designed products from various subject areas.

SERVICE & QUALITY













„I guarantee you best service and top quality.“

We make sure you have a good feeling and do everything to ensure our promotional items comply with your quality standards.



PRINT

-  Tampon print
-  Embossing
-  Silkscreen print
-  Laser engraving
-  Transfer print
-  Embroidery
-  Etching
-  Doming
-  Labeling
-  Direct print
-  Digital transfer



THE PERFECT PLACE FOR YOUR PRINTING:

There are many ways to advertise your name. Under each product description, you can see what type of printing and size is best for your advertising medium. We are more than happy to provide you with more detailed information.



OUR PRINTING SERVICE FOR YOUR ADVERTISING MESSAGE:

You only have one chance to make a good impression – make the most of it! Your logo/slogan individualizes your advertising medium and should leave a lasting impression.



The logo imprints in this catalogue serve as examples of our printing service. This way, you can see in advance how the products will look with advertisement.

PICTOGRAMS

-  Alarm clock
-  Twin umbrella
-  Rib length
-  Automatic
-  Solar charges
-  Battery incl.
-  Battery excl.
-  Coin cell incl.
-  On wheels
-  Gift box
-  Digital display
-  Length of measuring tape
-  Isolated
-  Cowhide leather
-  Genuine leather
-  FM
-  FM-AM
-  Magnetic



SILKSCREEN PRINT/ TEXTILE PRINTING



For silkscreen print, a screen is made impermeable in areas not to be printed through a photochemical process. The promotional item is placed under the screen and printed on the areas where the screen is permeable. The colour is pushed through the holes and applied to the product. When using coloured logos it is recommended to add a white base coat to ensure brilliant colours. This method is ideal for flat surfaces, such as textiles or segments of umbrellas.



LASER ENGRAVING



A method using a laser beam to engrave a logo into nearly any material. A computer controlled process ensures a pinpoint reproduction. The final result is always dependant on the material surface. A colour replica is not possible.



EMBOSSING



A stamp is used to press a logo into the surface of an article. Coloured and metal-looking (in gold and silver) embossing are possible through special foils. This technique is mostly used on leather and synthetic leather products.



ETCHING



An electrolytic process – a piece of felt is soaked in corrosive liquid and is pressed through a stencil onto the product. Once the liquid comes into contact with the article the desired imprint is etched into the surface. The advantage is that the imprint is very robust.



DIRECT PRINT



With direct print, single drops of ink are fired through nozzles directly onto the item or paper (similar to an inkjet printer). Normally, colours that dry with UV light are used for high brilliance. Suitable for low quantity and flat items.



TAMPON PRINT



A template of the logo is made and filled with the desired colour of ink. Then the colour is transferred directly onto the article with a silicone pad. As this pad is made of flexible silicone, almost all surfaces can be printed – including uneven surfaces.



EMBROIDERY



A digitally controlled process in which a computer steers a needle and thread to embroider a surface. As many as 10 colours can be used in one embroidery procedure. This robust form of refinement can be used on all textiles. The logo must be provided in order to determine the number of stitches and perform an accurate cost calculation.



TRANSFER PRINT



A heat press, consisting of a heating plate and base plate, is used to apply the logo/ picture/ text, pre-printed on thermal paper, onto the item. Beforehand, the thermal paper was imprinted through silkscreen or digital print.



DOMING

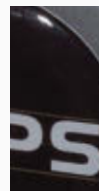

The doming sticker is made of synthetic resin and a sticker with the company logo. The clear resin is fitted precisely to the logo print, protects the print and gives the logo a 3D effect. The convex sticker is perfect for advertising on rough or hard materials, such as umbrella handle.

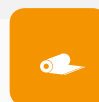

DIGITAL TRANSFER



Digital transfer works in two steps. First, a special thermo paper is imprinted digitally (see passage „direct print“) and cut to size. In a second step, the logo / picture / text is then printed onto the product under pressure in a heat press.

XXL PRINTING

Think big, make it big!

These items are well-suited for
XXL Printing.

The items displayed are examples of
printed products. You want your logo
to be big and bold? Feel free to
contact us!

Symbol for XXL Printing:



DIRECT PRINTING

*Versatile and colourful –
everything is possible!*

These items are well-suited for
Direct Printing.

We print your slogan pin sharp and in
full colour onto the product. The items
displayed are examples of printed
products. Together we lend colour to
the world!

Symbol for Direct Printing:





360° ENGRAVING

*All around satisfaction –
with engraving.*

These items are well-suited for 360° engraving.

The items displayed are examples of engraved products. There is no limit to your creativity!

Symbol for 360° engraving:

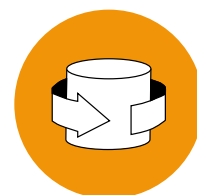

ATTENTION 56-0488006

Promotional package "Attention" for night owls – consists of: 100 reflective snap bands with metal spring

Branding:

☰ 60x18mm

*Incl. single-coloured tampon print in one position!
Plus initial costs.

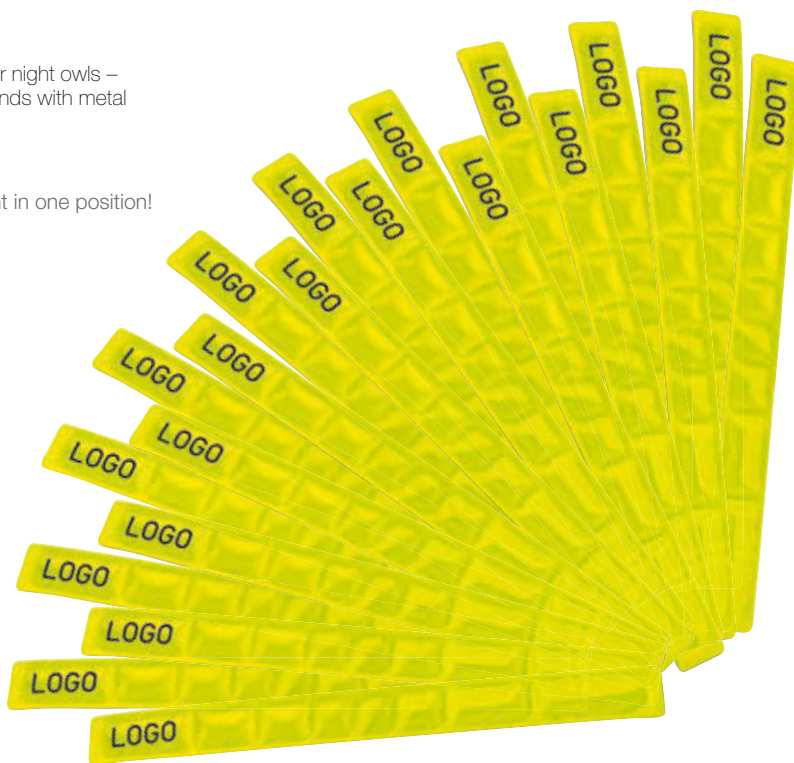

100
pieces
incl. print*

HAPPY SHINE 56-0488007

Promotional package "Happy Shine" that makes your advertisement shine in a good light – consists of: 50 torches with key rings

Branding:

☰ 30x5mm

*Incl. single-coloured tampon print in one position! Plus initial costs.



50
pieces
incl. print*

HAPPY CAR 56-0488005

Promotional package "Happy Car" for frequent travellers – consists of: 100 ice scrapers with built-in parking meter, 50 torches with key rings and 50 key rings

Branding:

☑ 25x5mm

*Incl. single-coloured tampon print in one position! Plus initial costs.



200
pieces
incl. print*

**HAPPY HELPER** 56-0488008

Promotional package "Happy Helper" for those who like to patch others up – consists of: 200 mini first aid kits with 5 adhesive bandages in a plastic box

Branding:

☑ 50x20mm

*Incl. single-coloured tampon print in one position! Plus initial costs.



200
pieces
incl. print*

DOOR-OPENER 56-0488002

Promotional package "Door-opener" with little things that make life easier – consists of: 100 key rings with bottle openers, 100 stick lighters (refillable gas filled) with control wheel to regulate the flame size and window to check fill level and 50 plastic ballpoint pens. Receive a trolley on top (boarding size suitable for low budget airlines)!

Branding:

☑ 20x5mm

*Incl. single-coloured tampon print in one position! Plus initial costs.



250
pieces
incl. print*



HAPPY HYPE 56-0488003

Promotional package "Happy Hype" for technophilic metropolitans – consists of: 100 key rings with LED lights, 150 plastic ballpoint pens with touch screen tip. Receive a stylish shoulder bag made of sturdy tarpaulin on top!

Branding:

☑ 20x6mm

*Incl. single-coloured tampon print in one position! Plus initial costs.



250
pieces
incl. print*



HAPPY WRITER 56-0488001

Promotional package "Happy Writer" for writing maniacs – consists of: 300 different plastic ballpoint pens

Branding:

☑ 65x5mm

*Incl. single-coloured tampon print in one position! Plus initial costs.

300
pieces
incl. print*

**HAPPY DESK** 56-0488004

Promotional package "Happy Desk" for paper pushers – consists of: 100 mini hole punchers to file into portfolios, 72 correction tapes and 150 ballpoint pens

Branding:

☑ 40x6/35x7mm

*Incl. single-coloured tampon print in one position!
Plus initial costs.

322
pieces
incl. print*



SERVICE & QUALITY

OFFICE & BUSINESS

MUSIC & TIME

LIGHTS & TOOLS

SAVE & PRACTICAL



OFFICE & BUSINESS

➤ *„My office is in top shape.“*

A colourful office puts me in a good mood and lets my ideas flow freely. I start my day well-organized with ballpoint pens and sticky notes. Work is no trouble with the right equipment and day-to-day business runs almost by itself.





ART LINE

Ballpoint pen "Art Line": with colourful plastic shaft and transparent clip, writing length: approx. 800 - 1000 m, black ink

Packing: 50/500 pieces | Size: 14,5 cm

Branding:

-  40x6/25x6mm K1
-  70x6mm DP1+H2





56-1102040 blue 56-1102041 black 56-1102042 red 56-1102043 green 56-1102044 petrol

ART LINE

Ballpoint pen "Art Line": with silver plastic shaft and transparent clip, writing length: approx. 800 - 1000 m, black ink

Packing: 50/500 pieces | Size: 14,5 cm

Branding:

-  40x6/25x6mm K1
-  70x6mm DP1+H2

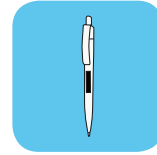

56-1102045 blue/silver 56-1102046 black/silver 56-1102047 red/silver 56-1102048 green/silver 56-1102049 petrol/silver



TUBULAR

Ballpoint pen "Tubular" with a frosted shaft, black ink

Packing: 50/1000 pieces |

Size: 11,4 cm

Branding:

-  35x7 mm K1+H2
-  35x6mm DP1+H2



56-1101094 red 56-1101092 blue 56-1101093 smoke 56-1101095 orange 56-1101096 green 56-1101097 lilac 56-1101098 yellow



SWAY

Ballpoint pen "Sway" with waisted shank form, pressure mechanism, blue jumbo refill

Packing: 50/500 pieces | Size: 14 cm

Branding:

☑ 35x7/12x6mm K1

☑ 35x6mm DP1+H2



56-1101991
blue



56-1101992
orange



56-1101993
red



56-1101994
green



56-1102005
black



56-1102006
bordeaux



56-1102007
yellow



56-1102008
magenta



56-1102012
apple green



56-1102013
petrol



56-1102009
white



56-1101995
blue/silver



56-1101996
orange/silver



56-1101997
red/silver



56-1101998
green/silver



56-1102001
black/silver



56-1102002
bordeaux/silver



56-1102003
yellow/silver



56-1102004
magenta/silver



56-1102010
apple green/silver



56-1102011
petrol/silver

TWISTER

Ballpoint pen "Twister" with a coloured rubber grip area and lanyard, black refill

Packing: 50/1000 pieces | Size: Ø2x7-9,6 cm

Branding:

☑ 20x7 mm K1+H1



56-1101584
blue/silver



56-1101585
black/silver



56-1101588
red/silver



56-1101586
green/silver





56-1101587
orange/silver

FUERTE

Ballpoint pen "Fuerte" with black, red and blue refill and pencil, with coloured transparent clip and tip

Packing: 100/500 pieces | Size: 13,5 cm

Branding:

-  25x6mm K1+H2
-  35x8/20x3mm K1+H2



56-1101831
white/blue



56-1101832
white/smoke



56-1101833
white/orange



 4 in 1

SOLUTION

Ballpoint pen "Solution" with press mechanism, protruding clip, refill with German ink, writing length approx. 700 m, blue ink

Packing: 50/500 pieces | Size: 13,8 cm

Branding:

-  25x6mm K1+H2
-  25x6mm DP1+H2

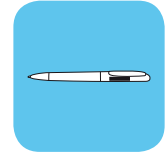

56-1102064
white



56-1102065
black



56-1102066
light blue



56-1102067
royal blue



56-1102068
red



56-1102069
orange



56-1102070
green



56-1102071
magenta

TOUCH

Ballpoint pen "Touch" with a large refill, ergonomically formed rubber grip, clip with a hole design, blue ink

Packing: 50/1000 pieces | Size: 14,7 cm

Branding:

-  30x7/20x7 mm K1+H2



56-1101040
silver/orange



56-1101038
silver/blue



56-1101039
silver/black



56-1101041
silver/red



56-1101042
silver/green

TOUCH

Ballpoint pen "Touch" with a large refill, ergonomically formed rubber grip, clip with a hole design, blue ink

Packing: 50/1000 pieces | Size: 14,7 cm

Branding:

-  30x7/20x7 mm K1+H2



56-1101043
white/blue



56-1101044
white/black



56-1101045
white/orange



56-1101046
white/red



56-1101047
white/green

PLAIN

Ballpoint pen "Plain": with press mechanism, plastic shaft, writing length approx. 800 - 1000 m, black ink

Packing: 50/500 pieces |

Size: 13,8cm

Branding:

 70x5mm K1+H1

 80x5mm DP1+H1

 50x5mm L1+H1



56-1101956
black



56-1101957
white



56-1101958
blue



56-1101959
red



56-1101960
green



56-1101961
orange



56-1101962
yellow

UTAH

Ballpoint pen "Utah": withpress mechanism, a large refill, semi-transparent plastic shaft and bent clip, writing length approx. 800 - 1000 m, blue ink

Packing: 50/500 pieces | Size: 14,6cm

Branding:

 70x6mm K1+H1

 70x6mm DP1+H1

 50x5mm L1+H1



56-1102079
black



56-1102080
blue



56-1102081
red



56-1102082
orange



56-1102083
green

VALLEY

Ballpoint pen "Valley" with large refill, metal design, silver ring in the middle, black ink

Packing: 50/500 pieces | Size: 14,2cm

Branding:

 25x6mm K1

 25x6mm DP1+H2



56-1101065
blue



56-1101066
black



56-1101067
burgundy



56-1101068
green



56-1101069
orange



RETRO

Semi-transparent ballpoint pen "Retro", with black refill

Packing: 500/2000 pieces | Size: 14 cm

Branding:

 40x6/45x5 mm K1+H1

 40x24 mm S8+H1



56-1101261
transparent
blue

56-1101262
transparent
red

56-1101263
transparent
orange

56-1101266
transparent
white

56-1101267
transparent
smoke

JINGLE

Ballpoint pen "Jingle" with rubber grip, shaped clip and blue ink

Packing: 50/500 pieces | Size: 14 cm

Branding:

 40x6/15x6 mm K1+H2



56-1101123
blue/white

56-1101124
smoke/white

56-1101125
red/white

56-1101126
orange/white

56-1101127
green/white

MODERN

Ballpoint pen "Modern" with a matt silver-coloured plastic clip and black ink

Packing: 50/500 pieces | Size: 14,3 cm

Branding:

 45x6/20x3/20x6/35x7 mm K1+H1

 45x6 mm DP1+H2



56-1101117
dark magenta/white

56-1101111
blue/white

56-1101112
red/white

56-1101113
orange/white

56-1101114
green/white

56-1101115
lilac/white

56-1101116
pink/white



OREGON

Ballpoint pen "Oregon": with press mechanism, plastic shaft, with matt silver appliques under the clip as well as on clicker and tip, writing length approx. 800 - 1000 m, black ink

Packing: 50/500 pieces | **Size:** 14,2 cm

Branding:

☺ 50x5 mm K2+H2

☑ 50x5 mm L1+H2



56-1102030
black



56-1102031
white



56-1102032
blue



56-1102033
light blue



56-1102034
red



56-1102035
green



56-1102036
orange



56-1102037
pink

BLOB

Ballpoint pen "Blob": reinforced grip area in a coloured drop-design, curved clip, pressure mechanism, with black ink

Packing: 50/500 pieces | **Size:** 14 cm

Branding:

☺ 25x7 mm K1+H1



56-1101106
blue/white



56-1101107
black/white



56-1101108
red/white



56-1101109
orange/white



56-1101110
green/white

MIAMI

Ballpoint pen "Miami": with press mechanism, colourful accent behind the clip, large refill with German ink, writing length approx. 1.000 m, black ink

Packing: 50/500 pieces | **Size:** 14 cm

Branding:

☺ 25x3 mm K1+H2

☑ 25x5 mm DP1+H2



56-1102050
white/black



56-1102051
white/blue



56-1102052
white/red



56-1102053
white/orange



56-1102054
white/green

HEART BREAKER 56-1101667

Pen holder "Heart Breaker" with a ballpoint pen (blue ink) and approx. 57 cm long metal wire and double-sided tape on the back of the holder

Packing: 25/100 pieces | **Size:** 8x6x13 cm

Branding:

 25x20mm K1+H2

 25x20mm L4+H2

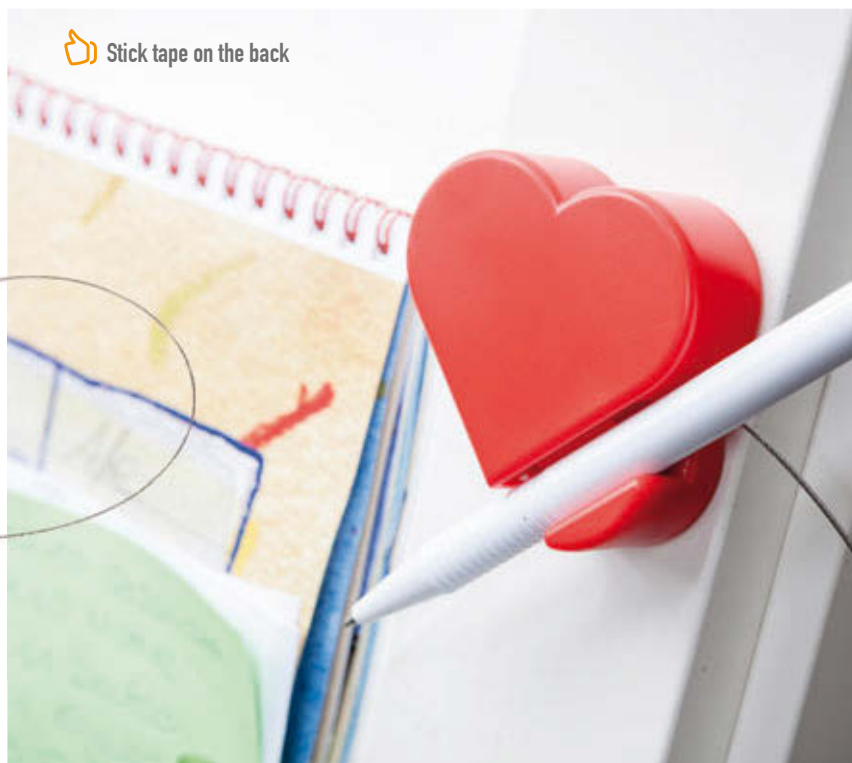
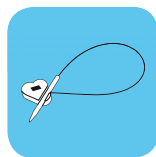
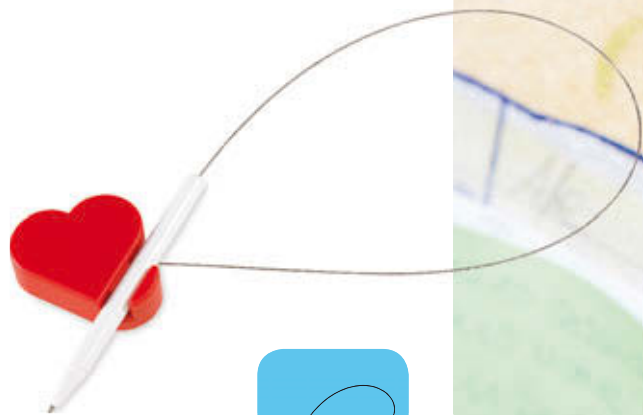

COUNTER 56-1101666

Pen holder "Counter" with a ballpoint pen (blue ink) and approx. 57 cm long metal wire with a weight in the inside of the holder

Packing: 25/100 pieces | **Size:** 8x6x13 cm

Branding:

 30x20mm K1+H2

 30x5mm L4+H3



VALENTINE 56-1101169

Ballpoint pen set "Valentine" with 2 ballpoint pens, a heart-shaped clip for attaching the pens, blue ink

Packing: 50/500 pieces | **Size:** 13,5 cm

Branding:

 30x6/5x12mm K1+H2



 Magnetic





LEGGY

Pen holder "Leggy" standing on 2 feet, ballpoint pen (black ink) connected to an elastic spiral cable, includes sticky pads on the feet to ensure a steady stand

Packing: 100/200 pieces | Size: 6,5x4x16cm

Branding:

☑ 20x15 mm K1+H2

☑ 25x25 mm DP1+H2



👉 **Stick tape**
under the feet



56-1101672
white/blue



56-1101674
white/orange



56-1101673
white/red

INJECTION

Transparent ballpoint pen "Injection" with number range, with blue ink

Packing: 300/1200 pieces | Size: 12,5cm

Branding:

☑ 60x7 mm K1+H1



56-1101172
red



56-1101173
blue



CLASSIC

Ballpoint pen "Classic" with a large refill, gold-coloured clip and decoration, with blue ink

Packing: 50/1000 pieces | Size: 13,5cm

Branding:

☑ 30x6mm K1+H1

☑ 35x12mm S8+H1



56-1101611
blue



56-1101615
black



56-1101618
burgundy

SKINNY

Ball point pen "Skinny" with large refill and rubber-coated grip, with black refill

Packing: 50/500 pieces |

Size: 14,4 cm

Branding:

☑ 30x5mm K1+H2



56-1101627
black/blue



56-1101628
black/red



56-1101629
black/green

WEDGE

Ballpoint pen "Wedge" with press mechanism, shaft in shiny metallic look, futuristic clip shape, refill with German ink, writing length approx. 700 m, black ink

Packing: 50/500 pieces | Size: 14,2 cm

Branding:

☑ 20x6mm K1+H2

☑ 25x5mm DP1+H2



56-1102055
silver



56-1102056
white



56-1102057
black



56-1102058
anthracite



56-1102059
blue



56-1102060
red



56-1102061
orange



56-1102062
green



ZETA

Ballpoint pen "Zeta": with twist mechanism, highlighter at the end of the shaft, rubber-coated grip area, shaft in metallic look, black ink

Packing: 50/500 pieces | Size: 14,6 cm

Branding:

☑ 40x5mm K1+H2



👉 Highlighter
with wax gel



56-1101174
black



56-1101175
white



56-1101176
silver



56-1101177
blue



56-1101178
red



56-1101180
green

56-1101179
orange



APOLLON

Ballpoint pen "Apollon": with spring mechanism, plastic shaft, metal tip and curved metal clip, black ink

Packing: 50/500 pieces |
Size: 14,5cm

Branding:
☑ 40x5mm K1+H2



56-1101181
white



56-1101182
black

POETRY 56-1101665

Ballpoint pen "Poetry": with twist mechanism, refill with German ink, writing length approx. 500-600 m, black ink, in box with viewing window

Packing: 50/100 pieces | Size: 13,6cm |
Material: Brass

Branding:
☑ 25x5mm K1+H3+V2
☑ 25x5mm L1+H3

**SEATTLE**

Ballpoint pen "Seattle" with a large refill, silver matt shaft and coloured hole design, with blue refill

Packing: 50/500 pieces |
Size: 13,5cm | Material: Metal

Branding:
☑ 40x6mm K1+H2+V1
☑ 40x6mm DP1+H2
☑ 20x40mm LR1+H2 360°
☑ 50x6mm L1+H2



56-1102241
silver/blue



56-1102242
silver/red



56-1102245
silver/black

**GIBBET** 56-1101668

Pen holder "Gibbet" with magnetic ballpoint pen (black ink), fastens itself on the bamboo gibbet

Packing: 25/100 pieces |
Size: 10x8x16cm

Branding:
☑ 40x25mm K1+H2+V1



 Magnetic



VANCOUVER

Ballpoint pen "Vancouver" with a large refill, rubber grip and silver decorations, with blue refill

Packing: 100/500 pieces | Size: 13,5 cm | Material: Aluminium

Branding:

-  40x6mm K1+H2+V2
-  20x20mm LR1+H2 360°
-  50x5mm L1+H2





ASCOT

Ballpoint pen "Ascot" with a shiny shaft and metal clip, blue ink

Packing: 50/500 pieces | Size: 14,1 cm

Branding:

-  30x6mm K1+H2+V2
-  25x5mm LR1+H2 360°
-  30x6mm L4+H2





IBIZA 56-1101910

Mechanical pencil "Ibiza" with a slim shaft, rubber-coated grip and eraser

Packing: 50/500 pieces | Size: 13,5 cm | Material: Aluminium

Branding:

-  35x6mm K1+H2+V2
-  20x40mm LR1+H2 360°
-  30x5mm L1+H2

 Pencil

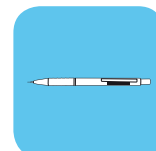

ELBA

Mechanical pencil "Elba" with a thin shaft, lies nicely in your hand

Packing: 50/500 pieces | Size: 13,7 cm | Material: Aluminium

Branding:

-  30x6mm K1+H2+V2
-  15x40mm LR1+H2 360°
-  30x5mm L1+H2

 Aluminium as a light metal distinguishes itself by high strength, reacts relatively insensitively on climatic conditions and does not rust.

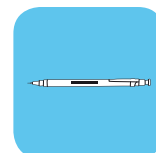

 Pencil



56-1101986
blue

56-1101988
anthracite

TOUCH METAL

Aluminium ballpoint pen "Touch Metal" with a large refill, ergonomically formed, rubber-coated, clip with square hole design, black ink

Packing: 50/1000 pieces | **Size:** 14,7 cm | **Material:** Aluminium

Branding:

☑ 30x7 mm K1+H2+V2

☑ 30x6mm L1+H2



56-1101048
blue

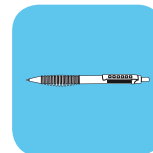

56-1101049
black



56-1101050
red



LUCERNE

Aluminium ballpoint pen "Lucerne" with a shiny shaft, large refill, partially rubber-coated grip and black ink

Packing: 50/1000 pieces | **Size:** 14,2 cm | **Material:** Aluminium

Branding:

☑ 30x7 mm K1+H2+V2

☑ 20x40mm LR1+H2 360°

☑ 30x7 mm L1+H2



56-1102015
blue



56-1102016
black



56-1102017
red



56-1102018
gold

CAYMAN

Ballpoint pen "Cayman": Grip area in discreet striped look, coloured-metallic shaft, pressure mechanism, with black ink

Packing: 50/500 pieces | **Size:** 14 cm | **Material:** Aluminium

Branding:

☑ 30x6mm K1+H2+V2

☑ 20x40mm LR1+H2 360°

☑ 30x6mm L1+H2



56-1101033
blue



56-1101034
silver







56-1101035
red

FOR YOU

Gift set "For you": consisting of ballpoint pen (blue ink) and colour-coordinated key ring

Packing: 20/100 sets | Size: 16,4x8,8x1,8cm

Branding:

-  40x6/25x15mm K1+H5+V1
-  160x80mm DP2+H2
-  40x8mm DP1+H2
-  40x6mm L1+H4



56-1101640
blue

56-1101641
black



56-1101642
red



PRESTON

Writing set "Preston" consists of ballpoint pen (black ink) with large refill pen (black ink) and pencil, grip with shiny hole design, packed in a case with transparent lid

Packing: 25/150 pieces |

Size: 16,9x5,4x2,5cm

Branding:

-  25x5mm K1+H4+V2
-  40x20mm K1+H2
-  50x20mm DP1+H2
-  25x5mm L1+H4



56-1101686
silver



56-1101687
blue



ALPHABET

Writing set "Alphabet": consists of twist action ballpoint pen (black ink) and rollerball pen (black ink), supplied in gift box

Packing: 25/100 sets | Size: 17,7x5,8x2,2 cm |

Material: Aluminium

Branding:

 20x8 mm K1+H4+V1

 150x50 mm DP2+H2

 20x6 mm DP1+H2

 25x5 mm L4+H4

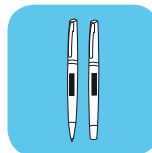

56-1101622
white



56-1101621
black



56-1101623
grey



56-1101624
blue



56-1101625
red



*My office is
my home.*



OVAL OFFICE 56-1101663

Pen set "Oval Office" consists of a ballpoint pen (jumbo refill, black) and a roller ball pen (black refill) with artificial leather shaft, packed in an oval case with pushbutton closure

Packing: 25/50 pieces | Size: 17,5x8,3x4 cm

Branding:

 60x20 mm K2+H4

 170x50 mm DP2+H2



BLACK SWAN 56-1101664

Writing set "Black Swan" consists of twist action metal ballpoint pen (blue ink), and metal rollerball pen (black ink)

Packing: 25/100 sets |

Size: 13,5/17,7x5,8x2,1 cm |

Material: ABS/Stainless Steel

Branding:

 20x6 mm K1+H4+V1

 20x6 mm L1+H4

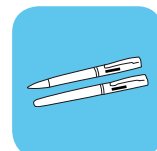

POET 56-1101656

Elegant pen set "Poet" consists of a ballpoint pen and fountain pen with a rosewood body and gold shining decorations, packed in a wooden case

Packing: 10/100 pieces |

Size: 17,3x5x2,4 cm | Material: wood

Branding:

-  40x15mm K1+H4
-  35x6mm K1+H5
-  160x40mm DP2+H2
-  35x15mm L4+H3
-  35x6mm L4+H5

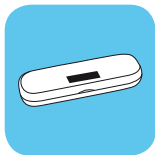

 Ballpoint pen + fountain pen

**VICI**

Pen set "Vici" consists of a twist ballpoint pen and rollerball pen, with blue refill, in zip case with decorative seam

Packing: 25/100 pieces |

Size: 16,5x6,3x2 cm | Material: polyurethane

Branding:

-  25x7 mm K1+H3+V2
-  70x25mm K2+H2
-  25x6mm L1+H3
-  50x30mm L4+H2

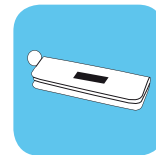

56-1101659
black



56-1101658
brown



NOBLESSE 56-1101662

Elegant desk set "Noblesse": consists of ballpoint pen (with blue refill) and fountain pen with chequered pattern, packed in a gift box

Packing: 25/50 pieces |

Size: 17,5x6,8x2,4 cm | Material: Metal

Branding:

-  35x7/70x25mm K1+H6+V2
-  90x40mm DP2+H2
-  35x7 mm L2+H6

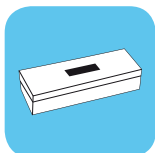



MANZONI 56-1101651

Pen set "Manzoni" consists of a ballpoint pen and fountain pen (with black refill) packed in an elegant gift box with aluminium plate

Packing: 25/50 pieces | Size: 18x6,5x4 cm

Branding:

-  35x6mm K1+H4
-  30x30mm DP1+H2
-  35x6/30x35mm L1+H4

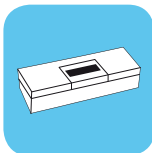
**LEONARDO** 56-1101653

Writing set "Leonardo" includes a ball point pen (blue ink), a roller ball pen (black ink) with a lid, packed in a gift box with a metal plate for engraving

Packing: 25/50 pieces |
Size: 13,7/19x7,5x3,2 cm

Branding:

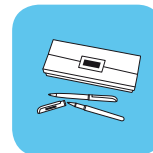

-  30x8mm K1+H2+V1
-  15x5mm L1+H4
-  30x8mm L4+H2

**ANGELO** 56-1101654

Writing set "Angelo" includes a ball point pen (blue ink), a roller ball pen (black ink) with a lid, in a blue metallic case with silver-coloured decoration elements, packed in a gift box with a metal plate for engraving

Packing: 25/50 pieces |
Size: 13,7/19x7,5x3,2 cm |
Material: Aluminium

Branding:

-  40x10mm K1+H4+V1
-  40x10/25x6mm L1+H4

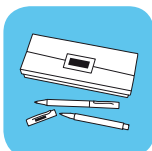
**CHROMIUM** 56-1101644

Pen set "Chromium" consists of a pen (black ink) and roller ball (blue ink) packed in an elegant gift box with aluminium plate

Packing: 25/50 sets | Size: 17,5x6,8x3,7 cm |
Material: Brass

Branding:

-  40x40mm K2+H2+V2
-  30x30mm DP1+H2
-  25x5mm L1+H4
-  40x40mm L1+H2+V2

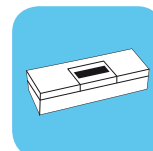

GEMINI

Writing set "Gemini" consists of a ballpoint pen with a torch, packed in a magnetic lid with a wire to hang around your neck, pen with a large refill, black ink

Packing: 50/200 pieces | **Size:** 11,9x2,3x1 cm

Branding:

- 12x20mm K1+H3
- 30x8mm K1+H3+V1
- 12x20mm L4+H3
- 30x8mm L1+H3



Writes + shines



56-1101903
silver/burgundy

56-1101901
silver

56-1101902
silver/blue



BEAM

Laserpointer "Beam": with red laser, white LED light, rubber grip area and shaped shaft, with black ink

Packing: 50/300 pieces | **Size:** 14,1 cm

Branding:

- 6x20/6x15mm K1+H4
- 6x8mm K1+H5

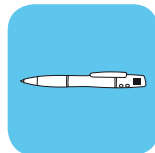

56-1102356
black

56-1102353
silver

56-1102354
blue

56-1102355
red

With laser pointer

AERIAL 56-1102342

Telescopic laser pointer "Aerial": extendable rod (50cm long) with a red laser and a screw-off cap for the ball pen, packed in a wooden gift box

Packing: 25/100 pieces | **Size:** 15 cm |

Material: Metal

Branding:

- 40x6mm K1+H2+V2
- 70x20mm K1+H4+V2
- 80x20mm DP2+H2
- 150x30mm LR1+H4 360°
- 35x5mm L1+H4
- 40x12mm L4+H2

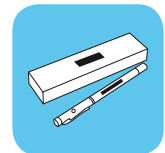

With laser pointer

PHASER 56-1102348

Ballpoint pen "Phaser" with PDA pen function, laser pointer and white LED light, shaped grip area, black ink, packed in a tin

Packing: 25/150 pieces | **Size:** Ø1 x 15 cm | **Material:** Metal

Branding:

-  40x6mm K1+H4+V2
-  70x20mm K1+H4+V2
-  160x30mm DP2+H4
-  20x40mm LR1+H4 360°
-  35x15mm L1+H4
-  40x6mm L1+H4



for 3 button cells, 3 extra

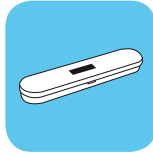

 With laser pointer

BUNDLE 56-1102345

Ballpoint pen "Bundle" with laser pointer and white LED light, black refill, packed in an elegant wooden case

Packing: 10/100 pieces | **Size:** 13,2xØ1cm | **Material:** Metal/Wooden Box

Branding:

-  40x6mm A1+H4
-  40x6mm K1+H4+V2
-  60x25mm K1+H4+V2
-  60x25mm DP2+H4
-  20x40mm LR2+H4 360°
-  35x12mm L4+H4
-  40x5mm L1+H4



for 3 button cells, 3 extra

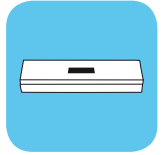

 With laser pointer

CHECK 56-1102343

Ballpoint pen "Check" with laser pointer, red laser, UV light - e.g. for checking money - with a rubber grip, packed in a metal box

Packing: 25/100 pieces | **Size:** 15 cm | **Material:** Metal

Branding:

-  40x6mm K1+H5+V1
-  70x20mm K1+H4+V1
-  160x30mm DP2+H2
-  35x15mm L1+H2
-  40x6mm L1+H3



for 3 button cells, 3 extra



 Laser pointer + UV light



My presentation will be perfect.



TOUCH TALENT 56-1102344

Laser pointer "Touch talent" with red laser, white LED lights and touchscreen point, ballpoint pen with blue ink, packed in metal box

Packing: 25/150 pieces | Size: Ø 1,6x 13/17,8x3,7x1,8cm

Branding:

-  30x6mm K1+H5+V2
-  35 x15mm K1+H4+V2
-  160x30mm DP2+H2
-  30x6mm L1+H5
-  35x15mm L1+H4

6x  INCL.

for 3 button cells, 3 extra

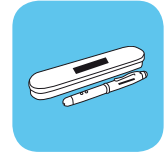

 With laser pointer and touchscreen tip





without decoration

SMART TOUCH 56-1101634

Ballpoint pen "Smart Touch" with thin outline, waved clip and touchscreen point, blue ink

Packing: 50/500 pieces | Size: 13,8cm

Branding:

-  20x3mm K1+H2+V2
-  20x4mm L1+H2

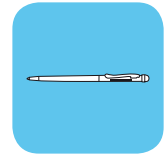

 With touchscreen tip





without decoration

SMART TOUCH COLOUR

Ball pen "Smart Touch Colour" with thin outline, colour matching touchscreen point at the end of the shaft, black ink

Packing: 50/1000 pieces | Size: 13,6cm | Material: Aluminium

Branding:

-  35x3mm K1+H2+V1
-  35x4mm L1+H2



 With touchscreen tip

56-1101490
white

56-1101491
black

56-1101492
blue

56-1101493
red

56-1101494
orange

56-1101495
green

56-1101496
apple green

56-1101497
yellow



56-1101498
magenta

SWAY TOUCH

Ballpoint pen "Sway Touch" with waisted shank form, turning mechanism, rubber-coated grip area and touchscreen point at the end, blue ink

Packing: 50/500 pieces | **Size:** 13,5 cm

Branding:

-  40x7 mm K1+H2
-  40x6mm DP1+H2



56-1102020
blue



56-1102021
red



56-1102022
green



56-1102023
orange



56-1102024
black



56-1102025
bordeaux



56-1102026
gold yellow

 With touchscreen tip



56-1102027
pink



56-1102028
white



56-1102029
silver





ELEGANT TOUCH

Ballpoint pen "Elegant Touch" with a slim silhouette, cap with clip, touchscreen point at the end of the shaft for tablets or smartphones use, refill with German ink, writing length approx. 1000 m, blue ink

Packing: 50/400 pieces | **Size:** 14,8 cm | **Material:** Brass

Branding:

-  30x5mm K1+H2+V2
-  30x5mm L1+H2

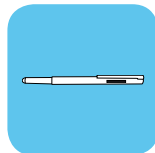

56-1102072
silver



56-1102073
black



56-1102074
white



56-1102075
blue



56-1102076
red



56-1102078
pink

 With touchscreen tip





56-1102077
green

SCREEN CLEAN

Touch ballpoint pen "Screen Clean": one side with ballpoint pen (black ink), end of the shaft with touchscreen tip to use with smartphones and tablets, pen stand with integrated business card and memo holder, and display wiper

Packing: 50/800 pieces | **Size:** 9,7x2,6x2,4 cm

Branding:

-  15x15/50x5mm K1+H2
-  15x15/50x5mm DP1+H2
-  15x15/50x5mm L1+H2

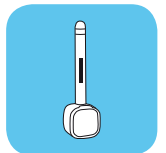

 With display wiper



56-1101543
white



56-1101544
black



56-1101545
blue



56-1101546
red

WIDGET

Portfolio "Widget": inside with elastic fastening straps for a tablet (size approx. 18x23 cm), with various slide-in pockets, 1 small writing pad, outside with fold-out stand (push button) for a comfortable reading position, snap-tab closure

Packing: 20 pieces | Size: 25x20x1 cm

Branding:

☑ 30x10mm K1+H2+V1

☑ 80x25mm T2+H2



56-1103220
blue



56-1103221
grey



56-1103222
red



56-1103223
orange



56-1103224
green



SESSION

Portfolio "Session" in DIN A4 format, includes writing pad, loop for writing utensil, various slip-in pockets, metal hook with coloured elastic band for closing

Packing: 20 pieces | Size: 32,5x25x1 cm

Branding:

☑ 170x100mm T2+H2

☑ 170x100mm S3+H2

☑ 25x8mm L2+H2



XXL
print

A4



56-1103215
black/blue



56-1103216
black/grey



56-1103217
black/red

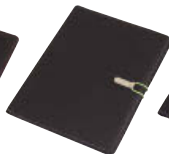

56-1103218
black/green



56-1103219
black/turquoise



LINEN 56-1103245

Portfolio "Linen": zip around the outside, various slip-in pockets inside, calculator, writing pad, loop for a writing instrument, cover with metal plate for your logo

Packing: 20 pieces | Size: 33x26x2,3 cm

Branding:

☑ 40x12 mm K2+H4+V1

☑ 40x12 mm L2+H4

8
DIGITS

**LINEN** 56-1103248

Tablet portfolio "Linen": cover can serve as tablet stand, inside with rubber-coated pad for sure tablet hold, suitable for 7" and 10" tablets, with writing pad, loop for a writing instrument, cover with metal plate for your logo

Packing: 40 pieces | Size: 25x19,7x1,2 cm

Branding:

☑ 40x12 mm K2+H4+V1

☑ 40x12 mm L2+H4

**LINEN** 56-1103246

Portfolio "Linen" in DIN A4 format: various slip-in pockets inside, 2 pockets with transparent window, with writing pad, loop for a writing instrument, cover with metal plate for your logo

Packing: 20 pieces | Size: 30,5x23,5x1,2 cm

Branding:

☑ 40x12 mm K2+H4+V1

☑ 40x12 mm L2+H4

**LINEN** 56-1103247

Portfolio "Linen" in DIN A5 format: various slip-in pockets inside, 1 pocket with transparent window, with writing pad, loop for a writing instrument, cover with metal plate for your logo

Packing: 40 pieces | Size: 23,2x17,3x1,2 cm

Branding:

☑ 40x12 mm K2+H4+V1

☑ 40x12 mm L2+H4



HILL DALE 56-1103252

Mini tablet portfolio "Hill Dale", DIN A5 size: fold-out tablet holder with elastic fixation belts, suitable for tablet PCs (7 inches) and iPad mini, incl. legal pad, loop for writing instrument – outside in stamped hole design with metal plate for your logo

Packing: 15/30 pieces | Size: 24,9x19,2x1,4 cm

Branding:

- ☞ 30x7 mm K2+H2+V1
- ☞ 40x10mm L1+H2



☑ A5

without decoration

NEW

HILL DALE 56-1103253

Passport wallet "Hill Dale": 5 slip-in pockets for credit cards and 1 mesh pocket for the passport – outside in stamped hole design with metal plate for your logo

Packing: 50/100 pieces | Size: 14,7x11,1x1,8cm

Branding:

- ☞ 30x7 mm K2+H2+V1
- ☞ 40x10mm L1+H2



without decoration

NEW

NEW JERSEY

Conference portfolio "New Jersey" in DIN A4 format: slip-in pocket with press stud inside, incl. writing pad, closable with flap and metal clasp for your advertising

Packing: 20 pieces | Size: 31,5x26x2cm

Branding:

- ☞ 180x65mm T2+H3
- ☞ 100x80mm S4+H3
- ☞ 6x25mm L2+H3



☑ A4



without decoration

56-1103233
red



56-1103231
black



56-1103232
blue



56-1103234
brown

HILL DALE 56-1103250

Ring binder file "Hill Dale", DIN A4 size: closed with zip, 2 ring binder, various slip-in pockets, 1 small pocket with press button closure, elastic band for powerbank etc., incl. legal pad, loop for writing instrument – outside in stamped hole design, with carrying handle, with metal plate for your logo

Packing: 10 pieces | Size: 33x26x5,3cm

Branding:

☑ 30x7 mm K2+H2+V1

☑ 40x10mm L1+H2



👉 A4

🛒 NEW

HILL DALE 56-1103249

Portfolio "Hill Dale", DIN A4 size: various slip-in pockets inside, 1 small pocket with press button closure, elastic band for powerbank etc., incl. legal pad, loop for writing instrument – outside in stamped hole design with metal plate for your logo

Packing: 15 pieces | Size: 33x26x2,5 cm

Branding:

☑ 30x7 mm K2+H2+V1

☑ 40x10mm L1+H2



without decoration

🛒 NEW

👉 A4

HILL DALE 56-1103251

Portfolio "Hill Dale", DIN A5 size: various slip-in pockets inside, incl. legal pad, loop for writing instrument – outside in stamped hole design with metal plate for your logo

Packing: 15/30 pieces | Size: 24,2x18,2x1,3cm

Branding:

☑ 30x7 mm K2+H2+V1

☑ 40x10mm L1+H2



without decoration

👉 A5

🛒 NEW



NOBLESSE 56-1103176

Portfolio "Noblesse" in DIN A4 format with calculator, note pad, pen strap, many slip-in pockets, all-round zip, white decorative stitching on the edge, made out of high-quality synthetic leather with metal plate for your logo

Packing: 10 pieces | Size: 35x28x4 cm

Branding:

-  70x25 mm K1+H3
-  120x250 mm T2+H2
-  30x10 mm L2+H2

1x
INCL.

 A4

**NOBLESSE** 56-1103177

Portfolio "Noblesse" in DIN A4 format with note pad, pen strap, many slip-in pockets, white decorative stitching on the edge, made out of high-quality synthetic leather with metal plate for your logo

Packing: 15 pieces | Size: 32x25x2,7 cm

Branding:

-  10x30 mm K1+H3
-  150x190 mm T2+H2
-  10x30 mm L2+H2

 A4

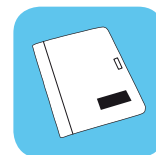
**NOBLESSE** 56-1103186

Portfolio "Noblesse" in DIN A4 format with integrated holder for tablet PC in 3 sizes (approx. 24x17,5 cm, 22x15,5 cm, 18x11,5 cm) with elastic bands to hold the tablet, suede pockets to ensure safe transport, various slip-in pockets for business cards and notes, loop for writing utensil and zipper to close it up

Packing: 10 pieces |
Size: 25,5x3x33 cm

Branding:

-  35x8 mm K1+H4+V2
-  70x25 mm K2+H2
-  100x30 mm T2+H2
-  30x10 mm L2+H4

 A4

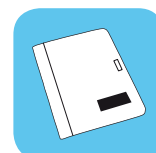

NOBLESSE 56-1103178

Note pad "Noblesse": with calculator, small note pad, pen holder, white decorative stitching on the edge, made out of high-quality synthetic leather with metal plate for your logo

Packing: 25/100 pieces |
Size: 13,7x9,1x2,8cm

Branding:

 30x10mm K1+H3

 50x45mm T2+H2

 30x10mm L2+H2

1x
 INCL.

**NOBLESSE** 56-1104122

Mouse pad "Noblesse" with an ergonomic wrist rest, non-slip base, white decorative edge stitching, made from high-quality synthetic leather

Packing: 25/50 pieces | Size: 27x22,5cm

Branding:

 20x20mm K1+H2

 Good for the joints

**NOBLESSE** 56-1103179

Good quality synthetic leather portfolio "Noblesse" in DIN A4 format with zip, ring binder, calculator, writing pad, loop for a writing utensil, various pockets, carrying handle, white decorative edge stitching and metal plate for your logo

Packing: 10 pieces | Size: 36,5x30x4 cm

Branding:

 30x10mm K1+H2

 250x150mm T2+H2

 30x10mm L2+H4

1x
 INCL.



 A4

without decoration

EVENT 56-0405715

Conference portfolio "Event" in DIN A4 format with writing pad

Packing: 10/40 pieces | Size: 33x24 cm

Branding:

-  50x20mm K1+H2
-  150x60mm DP2+H2
-  100x280mm T2+H2

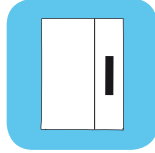

 A4



without decoration

SYMPOSIUM 56-0405725

Portfolio "Symposium" in DIN A4 format with zip, writing pad, several slip-in pockets and a pen holder

Packing: 5/20 pieces | Size: 34x25,5 cm

Branding:

-  40x20mm K1+H2
-  150x60mm DP2+H2
-  100x280mm T2+H2



 A4



without decoration

MANHATTAN 56-1103230

Portfolio "Manhattan" in DIN A4 format: with zip closure, various slip-in pockets inside, 1 see-through pocket, zippered inside pocket, incl. writing pad, loop for 1 writing utensil, front metal plate for your advertising on the outside

Packing: 10 pieces | Size: 33x26x1,8 cm

Branding:

-  25x7 mm L2+H4



 A4

**MONTE CARLO** 56-0406185

Clip board "Monte Carlo" in DIN A4 format and a loop for a writing utensil

Packing: 5/25 pieces | Size: 32,5x23x1,5 cm

Branding:

-  260x 160 mm DP2+H2
-  240x 140 mm T2+H2

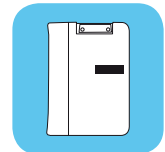

 A4



without decoration





Here, I am my own boss.



GENTLE

Notefolio "Gentle": with writing pad, ruled, approx. 50 pages, with elastic loop for a pen, handy faux leather binding with white decorative stitching

Packing: 50/100 pieces | Size: 13,9x8,9x1,8 cm

Branding:

- 70x25 mm K1+H2
- 70x85 mm DP2+H2
- 70x80 mm F2+H2
- 70x80 mm T1+H2
- 50x50 mm L5+H2



56-1103187
black



56-1103188
blue



56-1103189
red

GENTLE

Portfolio "Gentle" in DIN A4 format, zip around the outside, slip-in pockets on the inside, 1 transparent slip-in pocket, inner pocket with zip, calculator, writing pad, pen holder for 1 writing utensil and 1 slip-in pocket on the outside

Packing: 15 pieces | Size: 34,5x26x3 cm

Branding:

- 25x10/60x25 mm K2+H5
- 140x150 mm DP2+H2
- 140x220 mm T2+H3
- 140x25 mm T2+H5



56-1103184
blue



56-1103185
red



56-1103183
black



ARISTO 56-1103180

Conference file "Aristo" DIN A5 format with a turnable frame (one side with a calculator and the other for a photo), clear slip-in pocket for business cards, several slip-in pockets, loop for a writing utensil and a writing pad (20 pages), with white seams on the outside and a shiny metal plate for engraving a logo

Packing: 15/30 pieces | Size: 22,5x17,5x2 cm

Branding:

35x25mm S4+H3

30x10mm L2+H3

**ARISTO** 56-1103181

Conference file "Aristo" DIN A4 format with a turnable frame (one side with a calculator and the other for a photo), clear slip-in pocket for business cards, several slip in pockets, loop for a writing utensil and a writing pad (20 pages), with white seams on the outside and a shiny metal plate for engraving a logo

Packing: 20 pieces | Size: 32x23,5x2 cm

Branding:

35x25mm S4+H4

30x10mm L2+H4

**ARISTO** 56-1103182

Portfolio "Aristo" DIN A4 format with a turnable frame (one side with a calculator and the other for a photo), with a ring binder, 1 clear slip-in pocket for business cards, 1 CD slip-in pocket, several slip-in pockets, loop for a writing utensil and writing pad (20 pages), zip on the outside, white seams and a shiny metal plate for your logo

Packing: 10 pieces | Size: 34x24,5x4 cm

Branding:

35x25mm S4+H3

30x10mm L2+H2





*Comfortable writing
leads to success.*



CREADO 56-1103163

Portfolio "Creado" in DIN A5 format with writing pad and zip, aluminium plate for printing or engraving

Packing: 30 pieces | Size: 26x18x3,5 cm

Branding:

▮ 180x80mm T2+H2

✂ 30x10mm L2+H2

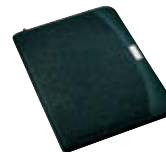

👍 A5

CREADO 56-1103161

Laptop bag "Creado" with padded main pocket and outside pocket with an aluminium plate for printing

Packing: 12 pieces | Size: 40x30,5x8 cm

Branding:

▮ 300x100/300x150mm T2+H2

✂ 35x10mm L2+H2



👍 Padded laptop
compartment



CREADO 56-1103162

Portfolio "Creado" in DIN A4 format with writing pad and zip and an aluminium plate for printing or engraving

Packing: 15 pieces | Size: 26x3,5x34,5 cm

Branding:

▮ 180x100mm T2+H2

✂ 30x10mm L2+H2



👍 A4

AVANTI 56-0406121

Ring binder file "Avanti" in DIN A4 format with a loop for a writing utensil, several slip-in pockets, carrying handle and zip, with writing pad

Packing: 5/10 pieces | **Size:** 35,5x25x5 cm

Branding:

☞ 300x120mm T2+H2

☞ 280x80mm S3+H2



☞ A4

**AVANTI** 56-0406171

Document bag "Avanti" with expandable bottom, organizer, clip closures, carrying handle and an adjustable and removable shoulder strap

Packing: 5/15 pieces | **Size:** 41x34x10 cm

Branding:

☞ 300x100mm T2+H2

**AVANTI** 56-0406131

Conference portfolio "Avanti" in DIN A4 format with writing pad, loop for a writing utensil with several slip-in pockets

Packing: 10/20 pieces | **Size:** 33x24x2,5 cm

Branding:

☞ 240x80mm DP2+H2

☞ 280x120mm T2+H2

☞ 280x120mm S3+H2



☞ A4

**AVANTI** 56-0406141

Conference portfolio "Avanti" in DIN A4 format with writing pad, loop for a writing utensil, several slip-in pockets and zip

Packing: 10/20 pieces | **Size:** 34x25x3,5 cm

Branding:

☞ 280x120mm T2+H2

☞ 240x80mm S3+H2



☞ A4



AMBASSADOR 56-0406172

Briefcase "Ambassador" with a main pocket and 2 front pockets with a zip, organizer, flap with an additional zip pocket and clip closure, extra pocket on the back with zip, 1 carrying handle, adjustable and removable shoulder strap

Packing: 5/15 pieces |
Size: approx. 41x33,5x10 cm

Branding:

≡ 300x60mm T2+H2
≡ 80x60mm T1+H2



without decoration

**AMBASSADOR** 56-0406173

Document bag "Ambassador" with a main pocket and an expansion crease, various slip-in pockets, twist locks, carrying handle, adjustable and removable shoulder strap

Packing: 5/10 pieces |
Size: approx. 39,5x31,5x6 cm

Branding:

≡ 300x60mm T2+H2
≡ 80x60mm T1+H2



without decoration

**AMBASSADOR** 56-0406175

Document portfolio "Ambassador" DIN A4 format, with zip closure, ring binder, various slip-in pockets, pocket on the inside with zip, writing pad, loop for 1 writing utensil with a carrying handle and a slip-in pocket on the outside

Packing: 5/10 pieces | Size: 35,5x25x7 cm

Branding:

≡ 270x60mm T2+H2
≡ 80x60mm T1+H2



without decoration

A4

AMBASSADOR 56-0406174

Portfolio "Ambassador" DIN A4 format, with a zip closure, various slip-in pockets, inner pocket with zip, writing pad, loop for 1 writing utensil and a slip-in pocket on the outside

Packing: 10/20 pieces |
Size: approx. 34x25x4 cm

Branding:

≡ 60x80mm T1+H2
≡ 60x270mm T2+H2



without decoration

A4

ATTENDANT

Notebook "Attendant" in DIN A6 format with rounded off corners, rubber band to close and integrated bookmark

Packing: 50/100 pieces | **Size:** 14,2x9,2x1,2 cm

Branding:

 30x30mm K2+H4+V3

 120x80mm DP2+H2



56-1103207
green



A6



56-1103200
black

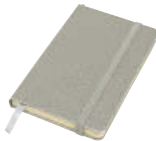

56-1103201
silver



56-1103202
navy blue



56-1103203
red



56-1103204
orange



56-1103205
pink



56-1103206
turquoise



56-1103227
white

 New colour

ATTENDANT

Notebook "Attendant" in DIN A5 format with rounded off corners, rubber band to close with integrated bookmark and extra slip-in pocket at the back for notes

Packing: 25/50 pieces | **Size:** 21,4x14,3x1,5 cm

Branding:

 50x20mm K2+H4+V3

 190x120mm DP2+H2



 A5

 New colour



A5



56-1103208
black

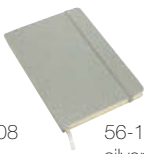

56-1103209
silver



56-1103226
red



56-1103225
navy blue

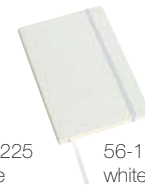

56-1103228
white

TINY

Mini portfolio "Tiny" with small writing pad (25 pages), calculator and loop for writing utensil

Packing: 25/50 pieces | Size: 16,5x10,9x1,7 cm

Branding:

 40x15mm P1+H2

 50x15mm K1+H2

 160x100mm DP2+H2

 8
DIGITS

 1x
INCL.



 A6



56-1103196
green



56-1103190
black

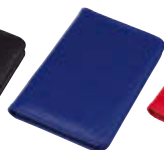

56-1103191
blue



56-1103192
red



56-1103193
orange



56-1103194
white



56-1103195
light blue

SCRIPT 56-1103116

Notebook "Script" includes a colour-matching pen

Packing: 50/150 pieces |
Size: 13,5x9,5x1,2 cm

Branding:

 45x20mm K2+H2

**YOUNG STAR**

Portfolio "Young Star" in DIN A4 format with writing pad, loop for writing utensil, various slip-in pockets, elastic band for closing, coloured on the inside and black on the outside

Packing: 20 pieces |
Size: 32x26x2 cm

Branding:

 100x220/20x220mm T2+H2

 A4



56-1103167
black/green



without decoration

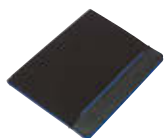

56-1103164
black/blue



56-1103165
black/grey

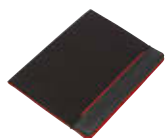

56-1103166
black/red

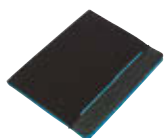

56-1103168
black/turquoise



RECYCLE

Notebook "Recycle" made out of recycled paper/cardboard, pen (black ink) from plastic/cardboard, with a ring back and a rubber band as a pen holder



Packing: 25/100 pieces |
Size: 14,5x10x0,8 cm

Branding:
☑ 40x40/40x20mm K1+H2



56-1103157
red

56-1103155
blue

56-1103156
black

RECYCLE

Notebook "Recycle" made out of recycled paper/cardboard in a DIN A6 format, pen (black ink) from plastic/cardboard, with a spiral binding and a rubber band as a pen holder



Packing: 25/100 pieces |
Size: 18x13,5x0,8 cm

Branding:
☑ 50x50mm K1+H2



56-1103152
blue

56-1103153
black

56-1103154
red



MAGNY

Notebook "Magny" with lined writing pad, 2 self-adhesive stickers, 5 coloured self-adhesive strips, includes pen, magnetic closure, recyclable



Packing: 25/50 pieces | Size: 18x13,6x2 cm

Branding:
☑ 50x50mm K1+H2

☑ With self-adhesive labels



56-1103212
red/nature

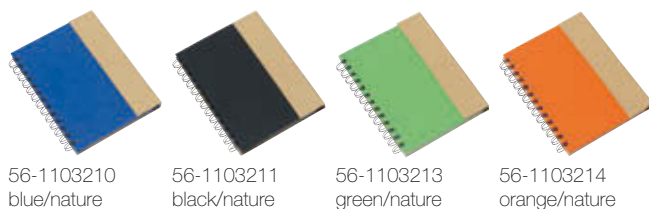

56-1103210
blue/nature

56-1103211
black/nature

56-1103213
green/nature

56-1103214
orange/nature





LITTLE NOTES

Notebook "Little Notes": 1 self-adhesive notepad, 5 different coloured self-adhesive labels, 1 tear-out writing pad, magnetic closure

Packing: 100/200 pieces | Size: 13,1x8,2x1,4 cm

Branding:

-  60x30mm K1+H2
-  60x30/20x70mm DP2+H2
-  60x30/100x70mm L5+H2

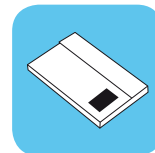

56-1103244
apple green



56-1103239
nature



56-1103240
black

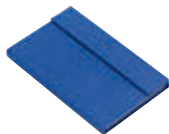

56-1103241
blue



56-1103242
red



56-1103243
orange



STICK + CALC

Memo box "Stick + calc" with 1 self-adhesive sticker block, 6 differently coloured self-adhesive stickers and 8-digit solar powered calculator

Packing: 50/250 pieces | Size: 8,9x5,8x1,1 cm

Branding:

-  40x25mm K1+H2



56-1103131
nature

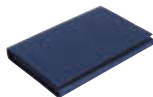

56-1103132
blue



56-1103133
red

RECALL

56-1103020

Memobox "Recall" with an 8-digit dual power calculator in the lid, 8 self-adhesive labels and 2 note pads

Packing: 50/100 pieces | Size: 13x10,1x1,9 cm

Branding:

-  25x10mm K1+H2
-  25x15mm DP1+H2
-  25x10mm L4+H2



CIRCULAR + ROMANCE

Bookmark "Circular" and "Romance": with 6 different coloured self-adhesive labels, ruler scale on the sides, recyclable

Packing: 100/400 pieces | Size: 21,2x6x0,2cm

Branding:

☰ 25x25mm K1+H2



56-1103032
natural - Circular



56-1103033
red - Romance



MEMO 56-1103138

Mini notebook "Memo" with ballpoint pen (black ink), 1 notebook with tear-out pages and 5 differently coloured self-adhesive notepads, made from recycled material

Packing: 100/200 pieces | Size: 10,5x8x1 cm

Branding:

☰ 35x20/25x20mm K1+H2

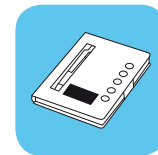

STICK ME 56-1103139

Memobox "Stick me" with self-adhesive notepad and 5 differently coloured self-adhesive pads, slip-in business card slots, elastic band around the front, made from recycled material

Packing: 100/500 pieces |

Size: 10,5x6,8x0,5 cm

Branding:

☰ 30x20mm K1+H2



STICK IT 56-1103136

Memobox "Stick it" with ballpoint pen (black ink), ruler, arrow-shaped labels in 3 different colours and 1 self-adhesive notepad, made from recycled material

Packing: 50/100 pieces | Size: 14x7,3x1,6 cm

Branding:

☰ 35x25mm K1+H2



DRAWER 56-1103135

Memo box "Drawer": notepad with 120 sheets, 20 paper clips in covered drawer – located underneath the 5x20 differently coloured sticky page markers – 1 mini ballpoint pen (black ink), cover made of recyclable cardboard

Packing: 25/50 pieces | Size: 16,5x10,4x2,2cm

Branding:

-  70x25mm K1+H2
-  150x90mm DP2+H2
-  150x80mm L5+H2



 With paper clip drawer



I like it tidy.

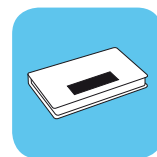

 **NEW**

**MULTI MEMO** 56-1103137

Mini ring binder book "Multi memo" with multi-coloured self-adhesive notepads, made from recycled material

Packing: 100/200 pieces |

Size: 7,5x8x2,2cm

Branding:



-  30x25mm K1+H2

**NOTE**

Memobox "Note" includes a note pad with 100 pages and memo flags - each colour has 100 pcs.

Packing: 25/50 pieces | Size: 16x8x1,5cm

Branding:

-  50x30mm K1+H2
-  140x60mm DP2+H2

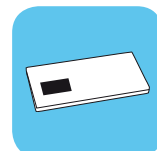

56-1103027
transparent

56-1103028
orange

COOL 56-1107024

Ruler "Cool": 2 compartments with 4 self-adhesive labels, 1 compartment for paper clips and a coloured lid

Packing: 50/200 pieces | **Size:** 14,8x6x0,8cm

Branding:

-  35x20mm K1+H2
-  100x40mm DP2+H2

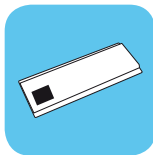
**DESK TALENT**

Staple remover "Desk talent" with integrated knife and self-adhesive labels

Packing: 100/600 pieces | **Size:** 14,5x2,3x1 cm

Branding:

-  35x11/10x10mm K1+H2

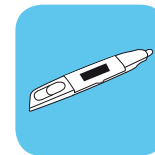

56-1101509
white/black

 With self-adhesive labels



56-1101508
white/blue



56-1101510
white/red

**STICK + MARK** 56-1103030

Memobox "Stick + Mark" with transparent slip-in pocket on the lid, contains 3 wax gel highlighters, 5 different coloured self-adhesive arrow-shaped labels and a self-adhesive notepad, packed in synthetic leather case

Packing: 25/50 pieces |

Size: 13,1 x 10,6x2,5cm

Branding:





-  40x25mm K1+H2
-  40x25mm K1+H2+V1
-  100x80mm DP2+H2

**REMINDE ME** 56-1103021

Self-adhesive label set "Remind me" consists of arrow-shaped labels in 8 different colours and 4 self-adhesive pads, transparent holders, packed in a case with synthetic leather

Packing: 25/50 pieces | **Size:** 13x10,5x3cm

Branding:

-  40x30mm P1+H2
-  40x20/40x25mm K1+H2+V1
-  100x80mm DP2+H2
-  40x20mm L4+H2

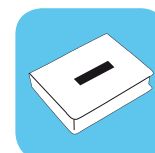

FIX IT 56-1101793

Paper clipper "Fix It" in transparent design, for sorting out notes

Packing: 100/400 pieces |
Size: 11,5x2,7x2,5 cm

Branding:
☑ 35x11 mm K1+H2

**TEAM** 56-1101723

Office clips "Team": with magnetic paperweight and 8 differently coloured metal clips

Packing: 25/100 pieces |
Size: 9,1 x 7,1 x 2,4/5,4 cm | Material: ABS/Metal

Branding:
☑ 40x25 mm K1+H4

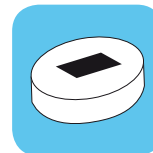

 Magnetic

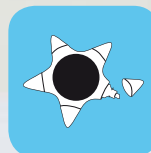
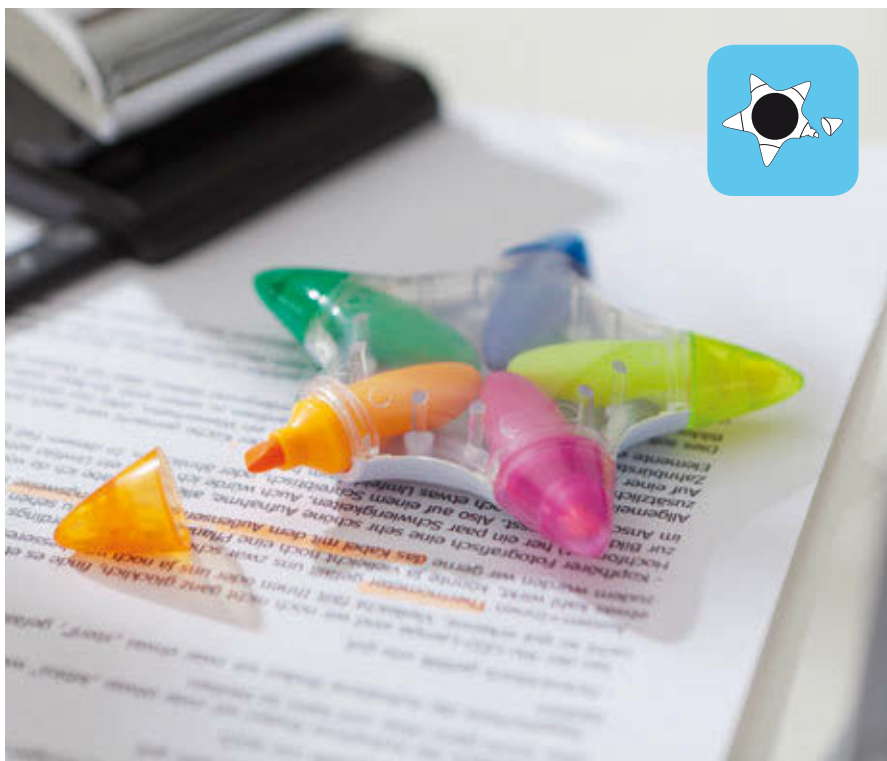
**STAR** 56-1103089

Highlighter "Star" with 5 colours and a transparent middle section

Packing: 50/150 pieces |
Size: Ø 11 cm

Branding:
☑ Ø40 mm K1+H4
☑ Ø20 mm DP1+H2



 CREADO

LIGHT UP 56-1103031

Highlighter "Light up": with 3 colours (yellow, pink and green) made from wax gel, packed in a transparent box

Packing: 50/200 pieces | **Size:** 8,7x4,9x2 cm

Branding:

-  30x7 mm K1+H4+V1
-  40x25mm K1+H2
-  80x40mm DP2+H2



 Doesn't dry out quickly

**REVOLVE** 56-1103084

Text marker "Revolve" with 3 coloured markers, yellow, green and pink

Packing: 50/200 pieces | **Size:** Ø2,9x14,8 cm

Branding:

-  40x10mm K1+H2

**MARK IT** 56-1103087

Triangular highlighter "Mark it" with 3 colours: pink, yellow and green

Packing: 100/500 pieces | **Size:** 9x9x1,3cm

Branding:

-  30x20mm K1+H2
-  50x50mm DP2+H2



I set colourful accents.



DESK STAR 56-1103043

Highlighter set "Desk Star": consists of 1 pen holder with tray for paper clips (incl.), 3 highlighters with liquid ink (pink, yellow, orange) with colour-coded caps and inspection window to check the contents

Packing: 20/60 sets | **Size:** 11,9x13x7,4 cm

Branding:

 30x8/30x7 mm K1+H4

**SPACE STAR 2** 56-1103044

Highlighter set "Space Star 2": consists of 1 pen holder, 2 highlighters with liquid ink (pink and yellow) with colour-coded caps and inspection window to check the contents

Packing: 25/75 sets |
Size: 10,3x8,5x4,3cm

Branding:

 35x20/30x7 mm K1+H4
 60x20mm DP2+H2

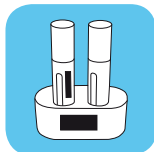
**TRIPLE STAR** 56-1103042

Highlighter set "Triple Star": consists of 1 pen holder, 3 highlighters with liquid ink (pink, yellow, orange) with colour-coded caps and inspection window to check the contents

Packing: 25/75 sets |
Size: 12x7,5x7,5 cm

Branding:

 55x8/30x7 mm K1+H4

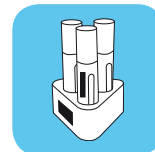
**SPACE STAR 4** 56-1103045

Highlighter set "Space Star 4": consists of 1 pen holder, 4 highlighters with liquid ink (pink, yellow, orange, green) with colour-coded caps and inspection window to check the contents

Packing: 20/60 sets |
Size: 10,3x12,4x4,3 cm

Branding:

 60x20/30x7 mm K1+H4
 60x20mm DP2+H2



INVITE

Business card holder "Invite" with a sliding lid, clip mechanism and a frosted bottom

Packing: 100 pieces | Size: 10x6,8x1 cm

Branding:

- ☒ 40x20mm K1+H4
- ☒ 90x60mm DP2+H2

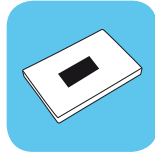

EASY + CLEAN 56-1101794

Correction tape "Easy + Clean", in transparent plastic body

Packing: 12/432 pieces | Size: 8,7x4,7 cm

Branding:

- ☒ 20x20mm K1+H2
- ☒ 50x20mm DP1+H2

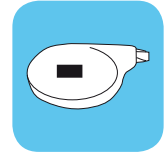

PAGE

Mini punch "Page" with built-in ruler (12cm) and 2 holes to file in a portfolio

Packing: 50/400 pieces | Size: 13x6,7 cm

Branding:

- ☒ 60x20mm K1+H2
- ☒ 40x20mm DP1+H2



DUSTY

Pen holder "Dusty": miniature wheelie bin, hold approx. 25 ballpoint pens – ideal for pens, coins, batteries, etc. – many wheelie bins of the same type can be connected through click function on the side



Packing: 25/100 pieces | Size: 10,1x8,7x13 cm

Branding:

 35x5/40x40mm K1+H2

 60x30mm L5+H2

 30x10mm L4+H2



56-1101798
orange

56-1101796
light blue



56-1101795
white



56-1101797
green



56-1101799
pink

**DESK COMPANION** 56-1101700

3in1 stapler "Desk Companion" with adhesive tape roller and 3M® memo tags

Packing: 25/50 pieces | Size: 19x7,5x4 cm

Branding:

 40x10mm K1+H3

 40x10mm L4+H3



 3 in 1



CREADO

 registered design

LECTOR 56-0409704

Magnify glass "Lector" with hole to hang up

Packing: 100/400 pieces | Size: 8,5x5,5 cm**Branding:**

☰ 25x8mm K1+H4

 **3-fold magnification**
SUPPORT

Magnifying glass "Support" in a handy credit card size, magnifies 3x, with prominent advertising space

Packing: 500/2500 pieces | Size: 8,5x5,5 cm**Branding:**

☰ 50x12mm K1+H2

☰ 50x10mm DP1+H2

56-0402468
white56-0402469
blue**3-fold magnification****CUBE** 56-0402417

Square memoholder "Cube"

Packing: 50/200 pieces | Size: 2,5x2,5x11 cm**Branding:**

☰ 18x18mm K1+H2

☰ 20x20mm DP1+H2

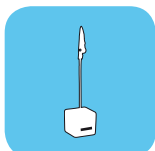
**ZEPHYR** 56-0402435

Memo holder "Zephyr" with metal clip

Packing: 50/500 pieces | Size: 4,9x1,9x11 cm**Branding:**

☰ 35x15mm K1+H2

☰ 30x10mm DP1+H2

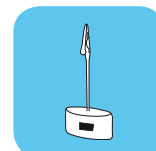

LOVE 56-1103000

Memo clip "Love" with a magnet

Packing: 50/300 pieces | Size: 7,1x7x3,1 cm**Branding:**

☑ 35x15mm K1+H2

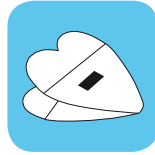

without decoration



Magnetic

SHAKE HANDS 56-1107031

Hand formed magnet "Shake Hands"

Packing: 100/500 pieces |

Size: 4,5x5x0,3cm | Material: Stainless Steel

Branding:

☑ 15x10mm K1+H2+V1

☑ 15x12mm DP1+H2

☑ 15x12mm L1+H2



Magnetic

**LITTLE MAN** 56-1101507

Business card holder "Little Man": with skipjack effect (weight in the foot)

Packing: 25/100 pieces | Size: Ø5,5x10,5 cm**Branding:**

☑ 25x10mm K2+H2+V1

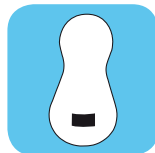
**NAVIGATION** 56-0603030

Elegant chrome designed compass "Navigation" with a wide metal rim, packed in a metal box

Packing: 50/100 pieces |

Size: Ø5,3x1,5/10,5x8,4x2,5 cm

Branding:

☑ 60x20mm K1+H2+V1

☑ 90x60mm DP2+H2

☑ 35x15mm L1+H2



without decoration



Also a paperweight

BRIMSTONE 56-0410203

Solar butterfly "Brimstone", wings begin to move when exposed to sunlight

Packing: 25/100 pieces | Size: Ø5x6 cm

Branding:

☰ 20x6mm K2+H4

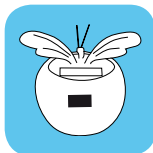

☰ Solar

**HULA**

Solar wobbler "Hula" moves hips as soon as the solar panel is exposed to the sun

Packing: 50/100 pieces | Size: 6x5,1 x 10,1 cm

Branding:

☰ 20x7 mm K1+H4



☰ Solar



56-0410204
blue



56-0410205
green



56-0410206
pink

WAVER + WAVING ROSE

Solar flower "Waver + Waving rose": When the solar panels are exposed to the sunlight the flower and leaves begin to move

Packing: 25/100 pieces | Size: Ø6,5x11 cm

Branding:

☰ 20x6mm K2+H4



☰ Solar



56-0410201
red/Waver

56-0410202
white/Waving rose



PROTECTOR

Credit card sleeve "Protector": with RFID blocking to protect from unwanted scanning, made of robust hard plastic – perfect protective sheath for debit cards, credit cards, IDs, tickets, insurance cards, etc.

Packing: 500/1000 pieces | Size: 9x6x0,4 cm

Branding:

-  70x25/50x50mm K1+H2
-  70x35mm DP2+H2
-  70x30mm L5+H2

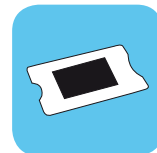

56-0402487
blue

 With RFID protector



56-0402486
white



56-0402488
red



56-0402489
apple green



56-0402490
magenta



56-0402491
turquoise

READ IT 56-1107214

Fold-out reading torch "Read it" with clip and turnable light, light turns on when the silver part is slide upwards

Packing: 50/200 pieces | Size: 9,5x4x1 cm

Branding:

-  22x35mm K1+H4
-  20x30mm DP1+H2

3x
INCL.



SAVER

Credit card case "Saver" with viewing window

Packing: 500/1000 pieces | Size: 9x6x0,3 cm

Branding:

-  50x17 mm K1+H2
-  80x20mm DP2+H2

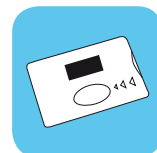

56-0402471
blue



56-0402470
white



56-0402472
red

SUPERB 56-1103103

Business card holder "Superb" with magnetic closure, synthetic leather with stitching and shining silver case, packed in gift box

Packing: 20/100 pieces | **Size:** 9,2x6,5x1,1 cm

Branding:

☰ 35x15mm K1+H2+V1

☰ 80x50mm DP2+H2

☒ 70x10mm L1+H2

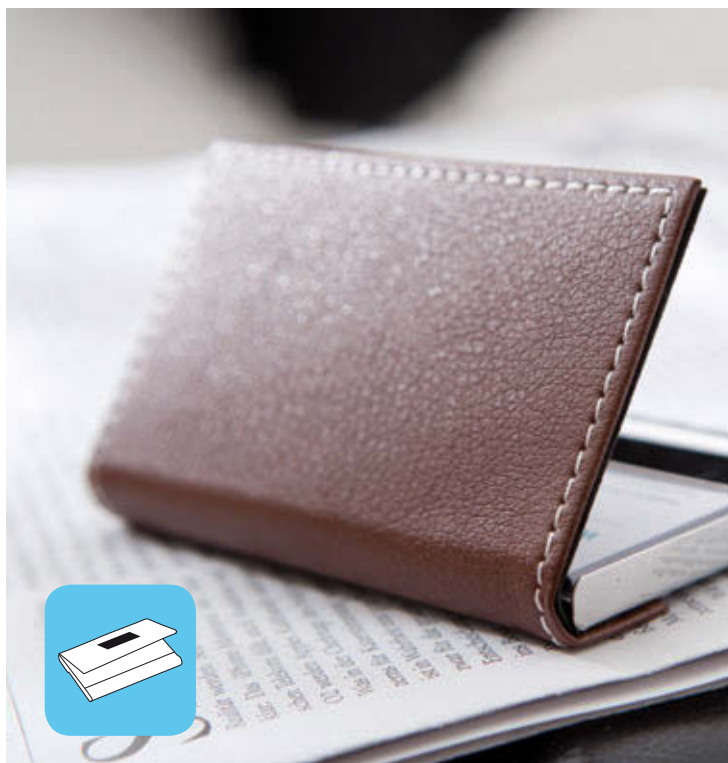
**COOL CARDS** 56-1103102

Elegant business card holder "Cool cards" with S/S plate and leather design

Packing: 50/250 pieces |

Size: 9,8x6,2x1,2cm |

Material: polyurethane

Branding:

☰ 30x15mm K1+H4+V1

☒ 30x15mm L1+H4

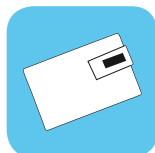
**LEAVE A MARK** 56-1103101

Elegant business card holder "Leave a mark" with S/S plate and leather design

Packing: 50/250 pieces |

Size: 9,5x6,5x1,2cm |

Material: polyurethane

Branding:

☰ 20x7mm K1+H4+V1

☒ 20x7mm L1+H4



GEOMETRY 56-1107027

Ruler "Geometry" packed in a pouch, 30cm

Packing: 50/200 pieces | Size: 31x4 cm |

Material: Aluminium

Branding:

☑ 70x20mm K2+H2+V2

☑ 300x10mm DP2+H2

☑ 100x20mm L2+H2



30 cm

**ARC** 56-1107001

Rotatable photo frame "Arc" for 2 photos, each photo 15x10cm

Packing: 10/40 pieces | Size: 21 x 15 x 1 cm |

Material: Aluminium

Branding:

☑ 35x20mm K1+H2+V1

☑ 50x20mm DP2+H2

☑ 50x10mm L1+H2

**AKROPOLIS** 56-0407777

Letter opener "Akropolis" with mat decoration

Packing: 10/100 pieces |

Size: 15x1,5x0,5 cm | Material: Metal

Branding:

☑ 20x5mm K1+H2+V1

☑ 25x10mm L1+H2

**RHODOS** 56-0407776

Letter opener "Rhodos" with round area for advertising

Packing: 10/100 pieces | Size: 16,5x2,8cm |

Material: Zinc Alloy

Branding:

☑ 15x15mm K1+H4+V1

☑ 15x15mm L1+H4



DARK LINE 56-1103104

Business card holder "Dark Line" with brushed metal and mirrored area in gun metal design for branding

Packing: 50/200 pieces | Size: 9,5x6x1 cm

Branding:

-  40x15mm K1+H2+V2
-  90x50mm DP2+H2
-  40x15mm L1+H2

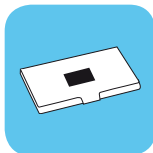

without decoration

**DARK LINE** 56-0407835

Fold-out bag holder "Dark Line" with brushed metal, mirrored area in gun metal design for branding, silicone-coated bottom to ensure safe hold, packed in gift box

Packing: 50/250 pieces | Size: Ø4,5x1 cm

Branding:

-  Ø30mm K1+H2+V2
-  40x40mm DP2+H2
-  Ø30mm L1+H2

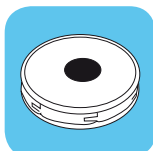

without decoration

**DARK LINE** 56-0407779

Letter opener "Dark Line" with brushed metal, mirrored area in gun metal design for branding

Packing: 50/200 pieces |

Size: 16x2,7x0,4 cm

Branding:

-  20x12mm L1+H4

**DARK LINE** 56-0407814

Key ring "Dark Line" made from brushed metal with fold-out key ring and gun metal design

Packing: 50/250 pieces | Size: 6,5x2x0,6 cm

Branding:

-  10x30mm K1+H2+V2
-  10x30mm DP1+H2
-  10x30mm L1+H2



DARK LINE 56-0407775

Gift set "Dark Line", in gun metal optics: consists of ballpoint pen with twist mechanism (black ink) and key chain with elegant reflecting surface for advertisement, in gift box



Packing: 20/100 sets | Size: 16x9x1,6cm |
Material: Zinc Alloy / Aluminium

Branding:

- ☑ 25x11/30x6mm K1+H5+V1
- ☑ 25x11/30x6mm L1+H5

**EXCELLENCE** 56-0407778

3 piece gift set "Excellence" consists of a ballpoint pen (blue ink), business card holder and a key ring with a metal plate to engrave a logo, packed in a gift box



Packing: 12/36 sets | Size: 16,7x16x3,4cm

Branding:

- ☑ 30x10mm P2+H5
- ☑ 25x8/30x8mm K1+H5+V1
- ☑ 25x8/35x8/30x8mm L1+H5

**ATLAS**

Business card holder "Atlas": with magnetic clasp and metal plate for advertisement

Packing: 50/200 pieces |
Size: 9,6x6,5x1,1 cm

Branding:

- ☑ 35x7 mm K1+H2+V1
- ☑ 35x7/80x8mm L1+H2

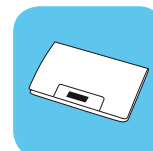

56-1103150
magenta



56-1103146
black

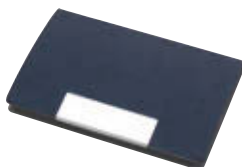

56-1103147
blue



56-1103148
red



56-1103149
green



TALENT 56-0499074

Digital luggage scale "Talent" features a blue LCD screen, stable hanger, measures to 35 kg, adjustable to lbs, hold and tara function, for personal use only, useable in the household or outdoors

Packing: 20/40 pieces |

Size: 31,5x4,5x2,2 cm

Branding:

 31 x 12 mm D1

 20 x 12 mm K1+H3

 50 x 15 mm T1+H3

2x
 INCL.



 Up to 35 kg

without decoration

**TOUCHY** 56-1104472

8-digit calculator "Touchy" with rubber-coated orange buttons

Packing: 50/200 pieces |

Size: 11,5x6,6x0,5 cm

Branding:

 30 x 15 mm K1+H3

8
DIGITS  **1x**
INCL.



SLIM ELEGANCE 56-1104280

8-digit dual power super slim calculator "Slim Elegance" in the size of a credit card with transparent buttons packed in a pouch

Packing: 50/200 pieces | Size: 8,5x5,5x0,5 cm | Material: Aluminium

Branding:

☑ 35x10mm K1+H2+V1
☑ 35x10mm L1+H2

**SLIM ELEGANCE** 56-1104281

8-digit dual power super slim calculator "Slim Elegance" in handy size with transparent buttons packed in a pouch

Packing: 50/200 pieces | Size: 10x5,5x0,5 cm | Material: Aluminium

Branding:

☑ 40x10mm K1+H5+V2
☑ 40x5/40x12mm L1+H5

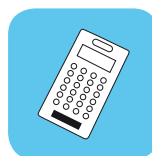
**CALCULINE** 56-1104457

8-digit ruler calculator "Calculine", 20cm with transparent scaling

Packing: 35/140 pieces | Size: 20,5x5,5x1 cm

Branding:

☑ 50x10mm K1+H4+V1
☑ 50x10mm L4+H4

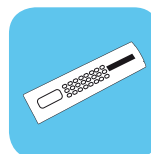



BUDDY

Calculator "Buddy" in a DIN A4 format with dual power and large rubber buttons, 10 digits

Packing: 20 pieces | Size: 28,5x21 x1,5 cm

Branding:

 40x35mm K2+H4

 40x30mm DP2+H2

 40x35mm L5+H4



56-1104465
blue



56-1104466
silver



 A4



56-1104464
red

 Calculators equipped with dual power function with batteries and solar energy.

CORNER

8-digit dual power desktop calculator "Corner" with slanting screen

Packing: 100 pieces | Size: 12x11 cm

Branding:

 35x35mm K1+H4

 30x30mm L4+H4



56-1104095
black



56-1104096
white



GLOSSY 56-1104467

8-digit dual power calculator "Glossy" with rubber buttons and big keypad

Packing: 20/40 pieces | Size: 20x13,5x3cm

Branding:

 60x7/70x10mm K1+H2

 50x10mm L4+H2

 1x EXCL.  8 DIGITS 

AA/LR6/AM3

**DOTTY MATRIX** 56-1104412

10-digit calculator "Dotty Matrix" in elegant design, dual power, helpful stand, dot-matrix screen

Packing: 25/50 pieces | Size: 18,3x10,6x3cm

Branding:

 55x15mm K1+H4

 11x3/3x12mm L4+H4

 10 DIGITS  1x INCL. 



 10 digits

NEWTON 56-1104413

12-digit dual powered calculator "Newton" with touch screen surface and practical stand on the back

Packing: 50/100 pieces |

Size: 15,8x10,5x0,8cm

Branding:

 60x15/20x12mm K2+H2

 60x15mm DP2+H2

 12 DIGITS  1x INCL. 



 Touch Screen

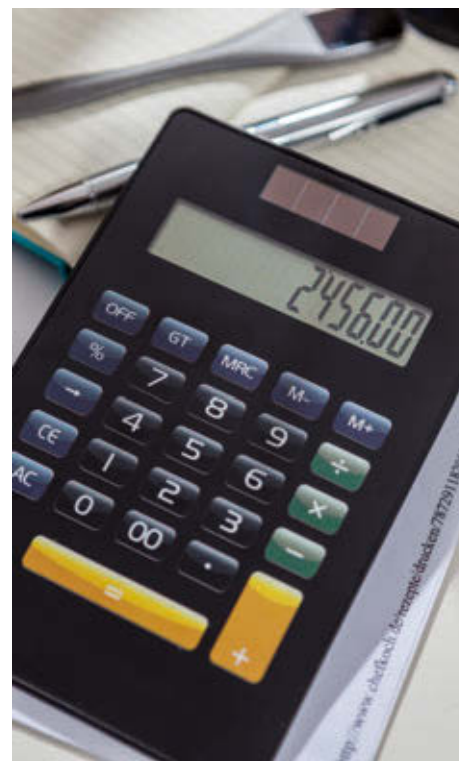

NEW LINE 56-1104125

Mouse pad "New Line": with practical dent for a pen, in faux leather look

Packing: 25/75 pieces |

Size: 24,7x19,8x0,5cm | Material: PU/PVC

Branding:

 70x25/45x45mm K1+H2

 120x180mm DP2+H2

 200x150mm L5+H2

**HOVER** 56-1104402

Light up mouse pad "Hover" with 3 USB ports and an integrated calculator, includes an USB cable (approx. 110 cm)

Packing: 20 pieces | Size: 20,8x18x0,8cm

Branding:

 60x15mm K1+H3

 **DIGITS**  **1x**  **INCL.**

**TOP PRIZE** 56-1104124

Mousepad "Top prize" in 500-Euro-note optics

Packing: 50/100 pieces | Size: 27,8x19,6cm

Branding:

 40x20mm K1+H2+V1

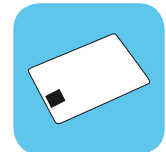

CLIMATE 56-1107357

USB air humidifier "Climate" – consists of 3 pieces: top with evaporator glows blue after power-on, body with sponge and transparent water tank, power supply via USB (length of cable approx. 105 cm) – provides healthy indoor climate when the air is dry

Packing: 30/60 pieces |
Size: Ø4,2x16 cm

Branding:

 12x70mm K1+H2
 15x70mm L4+H2



without decoration

HEAT IT

USB mug warmer "Heat it" with stainless steel heating plate, 3 ports, version 2.0, ON/OFF button, red light and USB cable (length approx. 100cm) included

Packing: 30/60 pieces | Size: 12x12x1,7 cm

Branding:

 40x10mm K1+H4
 40x10mm DP1+H2



without decoration

56-1107317
blue



56-1107319
green



56-1107320
pink



56-1107318
white





COFFEE + TEA 56-1107306

Practical USB cup warmer "Coffee + Tea" with hub and 4 connections, with on/off switch for the warmer

Packing: 10/40 pieces |
Size: 9,1 x 10,2 x 2,2 cm

Branding:

 10x10mm K1+H4
 10x10mm L4+H4



without decoration



MAGIC CUBE 56-1107353

Multi card reader "Magic Cube" with blue LED light, reads M2, MS, TF and SD with 3 ports, version 2.0, rubber-coated base, includes USB cable (approx. 112 cm long)

Packing: 20/80 pieces | Size: 8x8x4 cm

Branding:

☰ 45x10mm K2+H4

☒ 45x10mm L5+H4



DWARF 56-1107350

Card reader "Dwarf": reads XD, MS, SD, SDHC, M2, CF, Micro SD and T-Flash, version 2.0, with function lamp and USB cable (length approx. 30 cm)

Packing: 25/200 pieces |
Size: 7,1x4x1,5 cm

Branding:

☰ 20x18mm D1+H4

☒ 20x18mm K1+H4

☒ 60x30mm DP2+H2

☒ 20x18mm L2+H4

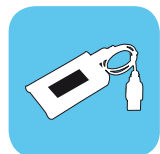

35IN1 56-1107331

Multi card reader "35in1" in an aluminium case, USB 2.0, reads CF, MS, Smart Media, SD, MMC and XD, includes connection cable (50cm)

Packing: 25/100 pieces |
Size: 7,2x4,9x1,6 cm |
Material: Aluminium

Branding:

☰ 40x35mm K1+H2

☒ 40x30mm DP2+H2

☒ 40x35mm L1+H2

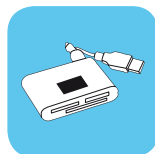

CLIP ON 56-1107351

USB-Hub "Clip on": with 4 USB-ports, version 2.0, USB-cable (length approx. 62cm) and practical clip for desktop fastening

Packing: 25/100 pieces |
Size: 6x5,3x4 cm

Branding:

☰ 35x15mm K2+H4



NORTH WIND

USB fan "North Wind": individually adjustable angle of inclination, fixed USB cable (length approx. 105 cm) for power supply, on/off switch on the back, stand with rubber-coated feet for secure hold



Packing: 24 pieces |
Size: 9,5x14,5x14,5 cm

Branding:

☞ 30x10mm L1+H2



56-0406322
red



56-0406320
white



56-0406321
blue



56-0406323
green



FLEXI

USB reading torch "Flexi" with 5 white LED, USB connection and flexible neck, packed in gift box

Packing: 50/200 pieces | Size: Ø 1,2x37,1 cm

Branding:

☞ 55x7 mm K1+H4+V2

☞ 55x7 mm L1+H4



flexible neck

56-1107356
black



56-1107355
silver



without decoration

PLATE 56-1107358

USB lamp "Plate": with 12 white LEDs, USB connector, and with flexible, adjustable neck (length approx. 34 cm) for ideal light entrance angle

Packing: 50/100 pieces | Size: Ø 5,6x40,5 cm |
Material: Metal/ABS

Branding:

☞ Ø 40 mm K1+H2+V1

☞ Ø 39 mm DP1+H2

☞ Ø 45 mm DP2+H2



NEW



without decoration



PHONE 56-1107333

SIM card backup "Phone" with red LED for incoming calls and key ring, saves up to 250 entries

Packing: 50/200 pieces |
Size: 9,5x4,5x1,8cm

Branding:
10x10/30x15mm K1+H2

2x
INCL.



Memory for your mobile phone

MULTI CHARGE 56-1107222

Adapter "Multi charge": for charging electronic equipment such as mobile phones, smartphones and MP3 players, with cable reel, length unrolled approx. 77 cm

Packing: 250/500 pieces | Size: 10x5 cm

Branding:
Ø 15 mm D1+H2
Ø 15 mm K1+H2

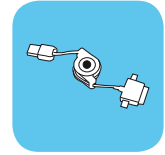

EDEN 56-1107312

Mobile phone holder "Eden" with a card reader for SD, Micro SD, MS and M2 memory cards (includes USB cable), rubber-coated mobile rest and shiny silver metal area for advertising

Packing: 25/100 pieces | Size: 11x10,1x6cm

Branding:
40x10mm K2+H4+V2
40x10mm L1+H4

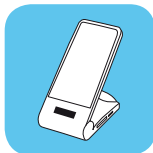

LOVE PICTURE 56-1107352

Digital photo frame "Love picture" with key ring, carabiner hook and USB connection (cable length approx. 78 cm), screen size 2x2cm

Packing: 25/100 pieces | Size: 5x4,8x1,5cm

Branding:
10x5/20x15mm K2+H4+V1

1-inch-screen



ON TOP 56-1107221

Smartphone accessory set "On Top": including in-ear headphones with 3.5mm audio jack (cable length approx. 117 cm), USB cable with micro USB port (length approx. 49cm), stylus pen with touchscreen tip, microfibre cleaning cloth, in practical box

Packing: 50/200 sets | Size: 11,4x6,7x2,2cm

Branding:

-  70x25mm K1+H2
-  80x35mm DP2+H2
-  70x30mm L5+H2

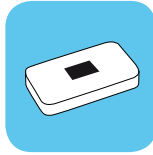
**HACKER** 56-1107310

USB/IT set "Hacker" with optical mini mouse, 4 port USB slim hub, 3 patch extensions and earphone with microphone extension, packed in a case with a zip and carrying handle

Packing: 10 pieces | Size: 14,5x14,5x5cm | Material: 600D Polyester

Branding:



 110x110mm T2+H2

**SUPER CHARGE** 56-1107223

Charging set "Super charge": 12/24-volt (cigarette lighter), output 5V, 1000 mA, USB cable with cable drum, USB socket power supply 100-230 volts, output 5V, 1000 mA, including 3 adapters for the most popular Smartphones and MP3 players, in drawstring bag

Packing: 25/100 pieces | Size: 11 x11,9x0,2cm

Branding:

-  8x15/30x10/Ø12mm K1+H4+V2
-  50x50mm T1+H4



I'm always mobile.

**EASY STAND** 56-0402430

Foldable mobile phone holder "Easy stand" with rubber-coated parts to ensure safe hold for mobile phones and PC tablets.

Packing: 125/500 pieces |

Size: 10,5x5,5x1,1 cm

Branding:

 40x15mm K1+H2





SUNSHINE 56-1107228

Solar panel charger "Sunshine" with an USB connection, suitable for small equipment such e.g. a mobile phone or MP3 Player, packed in a gift box, incl. 7 mobile phone connectors and 230 Volt adapter

Packing: 30 pieces | Size: 7,2x11,7x1,1 cm | Material: Metal

Branding:

-  20x5 mm K2+H7+V2
-  20x5 mm L1+H7



BACKUP 56-1107206

Powerbank "Backup" – the perfect spare power pack on the go: suitable for smartphone and USB devices, USB charger with micro-USB-plug (length approx. 30 cm), foldable micro-USB-cable to connect to mobile phone, with blue control light LED, input power: 1000 mA, output power: 5 V, 1000 mA, charging time: approx. 1 h, capacity: 1800 mAh, powerful lithium-ion battery

Packing: 50/100 pieces | Size: 9,7x6,3x0,7 cm

Branding:

-  70x20/50x45 mm K1+H4
-  65x45 mm DP1+H4

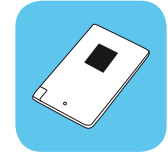

without decoration



CALL ME

Retro telephone "Call me" turns Smartphones into retro telephones with 3,5mm line-out connection for current Smartphones (excluding Nokia) and for calling via Skype and VOIP programmes.

Packing: 10/40 pieces |

Size: 21x5,7x1,9cm

Branding:

-  40x15 mm K2+H5



56-1107208
white

56-1107209
blue

56-1107210
black

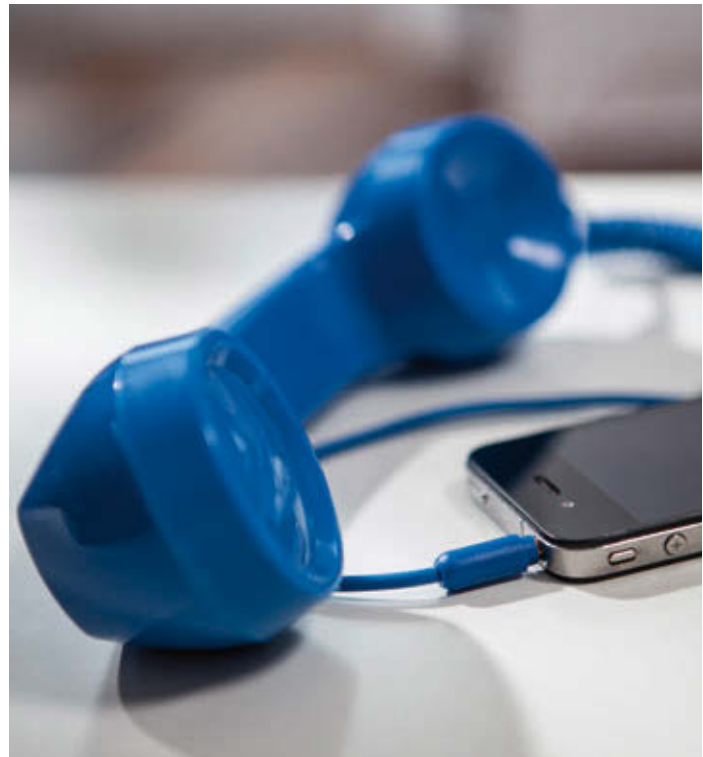

HELIOS 56-1107233

Powerbank "Helios": suitable for current smartphones and USB devices – on/off switch to check charge level and to start charging, with solar panel, 2 USB ports, 1 micro USB port, USB charging cable with micro USB plug (length: approx. 33 cm) – 1) USB mode: input power: 5V/1A, with blue LED charge level indicator, 2) charging via solar panel: input power: 5V, 200 mA, solar charge level indicator with green LED – capacity: 6.000 mAh, output power: 1. port 5V/1A, 2. port: 5V/2.1A, high-performance lithium-polymer-battery, LED lighting on the back, non-slip silicone casing with integrated telephone holder

Packing: 20/40 pieces | Size: 14,2x7,6x1,8cm

Branding:

- ☑ 30x30mm DP1+H4
- ☑ 20x10mm L1+H4

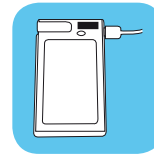

FORCE 56-1107232

Powerbank "Force" – the perfect power supply on the go: suitable for current smartphones and USB devices, USB charging cable with micro USB plug (length: approx. 33cm), with blue LED charge level indicator, input power: 1.000 mAh, output power: 5V, 1.000 mAh, capacity: 4.000 mAh, high-performance lithium-ion battery

Packing: 20/100 pieces | Size: 9x4,7x2,2cm

Branding:

- ☑ 70x15mm K1+H4
- ☑ 75x12/25x35/65x15mm DP2+H4
- ☑ 70x15mm L2+H4

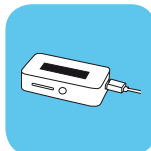

ENDURANCE

Powerbank "Endurance" – the perfect energy backup on the go: suitable for smartphones, iPhones, and USB devices, incl. USB cable with Micro-USB connector (length: approx. 25 cm), red charge control LED, blue operation indicator LED, on-off switch, input power: 5V, charge time: approximately 4 hours, capacity 2200 mAh, high-performance lithium-ion battery, elegant metal housing

Packing: 50/100 pieces | Size: 10x2x2cm

Branding:

- ☑ 13x40mm K2+H4+V2
- ☑ 13x60mm DP1+H4
- ☑ 13x40mm L2+H4



NEW SELFIE 56-1107218

Telescopic monopod "New Selfie" – ideal for taking self-portraits with smartphones and digital cameras: telescopic rod extendable from approx. 28,5cm to approx. 106cm, holder with angle of inclination of 180 degrees, with camera thread and mountable bracket, silicone handle with printable and detachable wrist strap

Packing: 50/100 pieces | Size: 28,5-106cm

Branding:

 70x8mm K1+H4+V1

 110x15mm T1+H4

 100x8mm L1+H4



SELFIE 56-1107216

Hand-held telescopic monopod "Selfie" – ideal for taking self-portraits with digital cameras or smartphones: telescopic rod extendable from approx. 22cm to approx. 106cm, holder with angle of inclination of 180 degrees, with camera thread and mountable bracket, silicone handle with wrist strap, in practical bag

Packing: 50/100 pieces | Size: 22-106cm

Branding:

 7x25mm K2+H5+V2

 80x60mm T2+H5

 7x25mm L1+H5



CLIK 56-1107220

Bluetooth trigger "Clik" for selfies with smartphones: suitable for models with iOS and Android, supports various photo apps, range approx. 10 m, with silicone case to attach to handle of telescopic monopod

Packing: 100/500 pieces | Size: 5,4x3,4x2,9cm |

Material: ABS





For my best snapshots.



SELFIE MINI

Telescopic monopod "Selfie Mini" – useful for taking self-portraits with smartphones up to 8,5 cm width: integrated cable can be attached to audio output jack of phone, trigger button on handle, compatible with ANDROID 4.1.2 and iOS 5.0 and newer (depending on configuration), with other models camera trigger function can be activated via photo app, telescopic rod extendable from approx. 23 cm to approx. 61 cm, holder with angle of inclination up to approx. 270 degrees, coloured foam rubber handle with printable and detachable wrist strap

Packing: 50/100 pieces | Size: 14-61 cm

Branding:

- 30x10mm K2+H4+V1
- 80x15mm F1+H4
- 80x15mm T1+H4
- 30x10mm L2+H4



56-1107251
blue

With trigger function



56-1107250
black



56-1107252
red



56-1107253
green



56-1107254
orange



56-1107255
pink

SELFIE 2.0 56-1107219

Telescopic monopod "Selfie 2.0" – ideal for taking self-portraits with smartphones and digital cameras: integrated cable can be attached to audio output jack of phone, trigger button on handle, compatible with iOS version 5.0 and Android version 4.1.2 and newer, with other models camera trigger function can be activated via photo app, telescopic rod extendable from approx. 30 cm to approx. 107 cm, holder with angle of inclination of 180 degrees, with camera thread and mountable bracket, silicone handle with printable and detachable wrist strap

Packing: 50/100 pieces | Size: 30-107 cm

Branding:

- 70x8mm K1+H4+V1
- 110x15mm T1+H4
- 100x8mm L1+H4



NEW

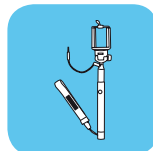

With trigger function

ROAD TRIP 56-1107224

USB adapter "Road Trip" with 12 and 24 Volt connection for the cigarette lighter, 5V output, 1000 mA, to charge current smartphones, digital cameras and MP3 players, packed in a gift box

Packing: 50/400 pieces | Size: Ø2,4 cm

Branding:

- 8x15mm K1+H3+V2



SERVICE & QUALITY

OFFICE & BUSINESS

MUSIC & TIME

LIGHTS & TOOLS

SAVE & PRACTICAL



MUSIC & TIME

➤ *„Everything for the right rhythm of life.“*

In the morning, I rock the shower. In the evening, I jog in time with the music. How time flies when one has fun... And since I don't want to count on my sense of time, I bank on reliable timekeepers. They ensure top timing round the clock.



WAKE UP 56-0406204

Bluetooth shower speaker "Wake up": splashproof on IPx4 protection level, rubber-coated body with operation menu, with speakerphone function, large suction cup at the bottom, power supply via USB, includes charging cable (length approx. 69 cm), powerful 600 mAh rechargeable battery

Packing: 30/60 pieces | Size: Ø8,5x5,3cm

Branding:

☞ 20x8mm K2+H4+V2

☞ 20x8mm L5+H4

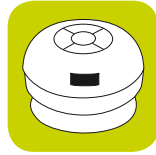

☞ With Bluetooth

**FRESH** 56-0406022

Shower radio "Fresh" with FM auto scan function and hanger

Packing: 25/100 pieces | Size: Ø10x3cm

Branding:

☞ 25x10mm K1+H4

3x
EXCL. FM

AAA/LR03/AM4



☞ For the shower



FREEDOM

Bluetooth speaker "Freedom" with Bluetooth 3.0, slot for micro SD card, includes charging cable with USB, miniUSB, and line-in connections (to USB ports and 3,5mm jack), plays audio stream (MP3) from source, with speakerphone hands-free function, integrated rechargeable battery, working time: approx. 5 h, charging time: approx. 2 h, max. range: approx. 10 m, in classy metal casing and rubber-coated bottom for a secure stand

Packing: 25/50 pieces | Size: Ø6x4,9 cm | Material: Metal

Branding:

☑ 20x20mm K2+H4+V1

☑ 20x20mm L2+H4+V3



CUBOID

Bluetooth speaker "Cuboid", music output: 3 Watt, Bluetooth version 3.0, to be paired with mobile phone, Bluetooth-MP3-player, tablet, etc., can be connected to external devices through 3,5mm line-in audio jack (cable length: approx. 50cm), slot for micro SD card, plays MP3s, with hands-free function, max. range: approx. 10 m, powerful battery, capacity: 300 mAh, incl. USB charging cable with micro USB plug (length: approx. 50cm), runtime: approx. 1 h, control keys on top, on/off switch on the back side, non-slip feet and coloured rubber casing

Packing: 25/50 pieces |

Size: 10,8x3,6x5,4 cm | Material: ABS

Branding:

☑ 30x25mm K2+H4+V1



☑ With Bluetooth

NEW

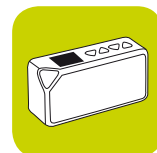

56-0406211
black



56-0406212
blue



56-0406213
red



56-0406214
green

CLASSIC 56-0406227

AM/FM radio "Classic" with elegant wooden design, frequency display with a blue background light, packed in a coloured gift box

Packing: 6 pieces | Size: 22,5x15,5x13 cm

Branding:

70x25 mm K1+H4

50x40 mm L1+H4

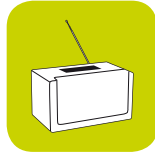

AA/LR6/AM3

**SOUNDRIDER** 56-0406230

Bicycle speaker "Soundrider": mono quality speaker, FM-radio, line-in connection 3,5 mm plug, plays MP3 or WMA audio files, USB 2.0, integrated card reader for TF/micro SD cards, including earphones, integrated rechargeable battery, USB-battery charger leads, easy to install

Packing: 10/40 pieces | Size: 8,8x3,8cm | Material: Aluminium

Branding:

35x11 mm K2+H6+V1

35x11 mm L2+H6



I like it loud.

**FREQUENCY** 56-0406228

FM radio "Frequency": fold-out antenna, with red power LED and blue LED light at the frequency display and volume control, with connections for headphones and external devices such as MP3-player and power adaptor (not included in the delivery extent), battery compartment on the back, packed in gift box

Packing: 10 pieces | Size: 10,5x9,5x15,6 cm

Branding:

70x40 mm K2+H4



AA/LR6/AM3



VOLUME

Headphones "Volume": adjustable headband, padded ear cups, 3,5mm jack plug with cable (length 122cm), frequency range 20 Hz-20 KHz, volume: 105 dB, in a gift box

Packing: 10/40 pieces |

Size: 17x13x2,6 cm

Branding:

☑ Ø20mm K2+H4



ROCKER 56-0406091

Padded headphones "Rocker" with fold-out headband and turnable ear speakers, 3,5mm plug with cable (length approx. 120cm), frequency range 20Hz-20KHz, volume is 105 dB

Packing: 10/40 pieces | Size: Ø 13 cm

Branding:

☑ Ø25/12x25 mm K2+H4



 **Folds flat to save space**



SHARE 56-0406109

Headphone signal splitter "Share": line-in connection for two headphone sets and 3,5mm audio jack plug, can also be used as a stand thanks to transparent suction cup – suitable for PCs, mobile phones, smartphones and tablets

Packing: 100/500 pieces | Size: Ø3,3x4,5cm

Branding:

☑ 12x6mm K2+H2

**LISTEN** 56-0406080

In-Ear-Earphone "Listen": 3 differently coloured top pieces for different ear sizes, line-in connection, cable length 116 cm, in plastic box

Packing: 50/200 pieces | Size: 7x7x1,6cm

Branding:

☑ 35x35mm K1+H2

☑ 60x60mm DP2+H2

**HOLD THE MUSIC**

In-ear headphones "Hold The Music": 3,5mm jack plug, cable length approx. 117 cm, in storage box with phone holder and frosted lid

Packing: 100/200 pieces | Size: Ø6,8x1,7cm

Branding:

☑ 40x20mm K1+H2

☑ 40x20mm DP1+H2

☑ 40x20mm L5+H2



56-0406246
white/red

56-0406244
white

56-0406245
white/blue



IN TIME

Watch "In Time": with single-hand control, digital display of time, date, and seconds, LED digits light up for approx. 7 seconds, magnetic lock, wristband can be shortened through cutting and therefore individually fit to wrist



Packing: 50/300 pieces | Size: 24,5x2x1 cm | Material: PU

Branding:

35x5 mm K2+H2+V1



2x
INCL.



56-0401943
white



56-0401944
blue



56-0401945
red



56-0401946
pink



MUSIC

In-ear headphones "Music": 3,5 mm jack plug, cable length approx. 117 cm, in colour matching storage box



Packing: 100/500 pieces | Size: Ø5,4x2,1 cm

Branding:

Ø30 mm K1+H2

Ø30 mm DP2+H2

56-0406235
blue



56-0406233
white



56-0406234
black



56-0406236
red



56-0406237
orange



56-0406238
green



Crank it up!



MODERN RETRO 56-0401019

Alarm clock "Modern Retro": with digital time and date display, two alarm times can be set, various alarm times for different week days possible, snooze function at five-minute intervals, blue background light, blue control keys at the sides



Packing: 25/50 pieces | Size: Ø10,4x7,3 cm | Material: ABS

Branding:

☰ 20x3 mm K1+H4

☒ 10x5 mm L1+H4



AAA/LR03/AM4

2 wake-up times can be set



NATURE 56-0401097

Multifunction alarm clock "Nature" with colour-changing light, 5 different nature sounds, timer function, integrated LCD screen and a transparent body

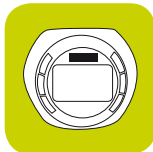

Packing: 25/50 pieces | Size: Ø10,5x8,2 cm

Branding:

☰ 20x15 mm K2+H4

☒ 10x5 mm L5+H4



AAA/LR03/AM4

Colour-changing mood light



Please find matching batteries for our articles on page 4.



I don't want to oversleep.

SMOULDER 56-0401018

Digital table clock "Smoulder": with light sensor – display glows in the dark – alarm and snooze function, date and time display, in gift box

Packing: 25/50 pieces | **Size:** 12,5x4,7x7,3cm

Branding:

☞ 55x10mm K1+H4
☞ 55x10mm L4+H4



AAA/LR03/AM4

With light sensor

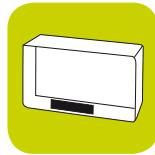
**FRAME** 56-0401223

Weather station "Frame" made out of solid wood with hygrometer and thermometer, clock with alarm, packed in a gift box

Packing: 5/15 pieces |

Size: 29,9x14,4x4,5 cm | **Material:** Metal/Wood

Branding:

☞ 70x25mm K1+H3
☞ 35x15/80x5mm L4+H3



AA/LR6/AM3

With a hygrometer and thermometer

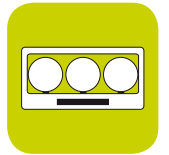
**TEAR OPEN** 56-0401203

Clock "Tear open" in a tin: with analogue time display, flap can only be opened once - with stand, eyelet for hanging and magnet on the back

Packing: 30/60 pieces | **Size:** Ø8,7x5 cm

Branding:

☞ 20x25mm K1+H2



AA/LR6/AM3

Magnetic



BUTLER 56-0401316

LCD alarm clock "Butler" with thermometer, date and aluminium front with a transparent pen holder

Packing: 30/60 pieces |
Size: 11,8x10,4x5,3cm

Branding:

☰ 25x15/40x10mm K2+H5+V1

☰ 50x30mm DP2+H2

☒ 30x10mm L1+H3



HELPSDEK 56-0401338

Digital clock "Helpdesk" with alarm, time, date, day and temperature, magnet in stand, includes 5 coloured paper clips

Packing: 50/200 pieces | Size: 9,4x9,4x2,4 cm

Branding:

☰ 10x10mm K1+H4

☰ 10x10mm DP1+H2



Magnetic



BUTLER 56-0401315

LCD alarm clock "Butler" with a built-in pen holder, date display and thermometer

Packing: 50/100 pieces |
Size: 11,8x9,5x5,3cm

Branding:

☰ 40x10/25x15mm K1+H5

☰ 50x30mm DP2+H2

☒ 30x10mm L4+H5



CARPE DIEM 56-0401142

Handy metal travel alarm clock "Carpe Diem" in a round pouch with press stud

Packing: 50/100 pieces | Size: Ø6x2,5cm |
Material: Metal/Polyurethane

Branding:

🔌 20x20mm K1+H2
🔌 20x20mm L4+H2

**DIGI** 56-0401057

Desk clock with transparent LCD and date display

Packing: 50/300 pieces | Size: 10,5x3x3cm

Branding:

🔌 35x12mm K1+H2
🔌 35x12mm L4+H2

**PICTIME** 56-0401329

Multifunctional use, foldable desk clock "Pictime" with pen holder and 2 photo frames

Packing: 20/80 pieces | Size: 7,5x6,5x10cm

Branding:

🔌 40x25/40x5mm K1+H4
🔌 35x15mm L4+H4

**SHOW** 56-1107016

Photo frame "Show" for one photo 10x15cm with thermometer, hygrometer and analogue alarm clock

Packing: 10/40 pieces | Size: 18x18x4cm

Branding:

🔌 60x10mm K1+H2
🔌 60x10mm DP1+H2
🔌 50x10mm L4+H2



AA/LR6/AM3



 With a hygrometer and thermometer



NO LIMIT 56-0401034

Radio-controlled clock "No Limit" with LCD screen, alarm clock, date display and thermometer, with blue background light

Packing: 25/50 pieces | Size: 12x8x2,5 cm

Branding:

- 60x8 mm K2+H3
- 60x8 mm L4+H3



AAA/LR03/AM4

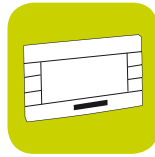

4 IN 1 56-0401324

Colourful desk alarm clock "4 in 1" with changing colour function when the clock is turned, alarm clock, date display, countdown and thermometer

Packing: 50/100 pieces | Size: 7x3,5x7 cm

Branding:

- 35x20/20x5 mm K1+H4



AAA/LR03/AM4

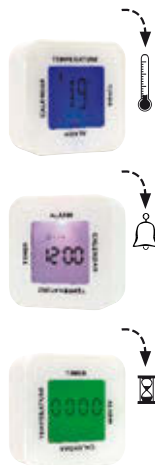

ASTER 56-0401308

LCD travel alarm clock "Aster" with thermometer, countdown and date

Packing: 60/120 pieces | Size: 7x6x1,5 cm

Branding:

- 20x3/Ø25 mm K1+H3
- 20x3 mm L4+H3



TOWER 56-0401205

LCD alarm clock "Tower" with thermometer, countdown and date, 3 round displays

Packing: 50/100 pieces | Size: 11x5,5x2,8cm

Branding:

☑ 17x15mm K1+H2

☑ 17x15mm L4+H2

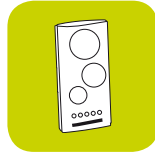
**PLUTO** 56-0401024

Multifunctional weather station "Pluto" with alarm clock and date

Packing: 10/60 pieces | Size: 7x1,3x11cm

Branding:

☑ 40x10mm K1+H4

☑ 40x10mm L4+H4



AAA/LR03/AM4

With a weather forecast

**SQUARE**

Table clock "Square": with alarm function, date and time display, thermometer (switchable from °C to °F) – with prominent advertising space, wall mount and fold-out stand on the back

Packing: 20 pieces | Size: 19,4x17,9x1,9cm | Material: ABS

Branding:

☑ 40x25/40x15mm K1+H4

☑ 110x50mm DP2+H4



AA/LR6/AM3



56-0401548
white



56-0401550
green

56-0401549
blue



SUNNY TIMES 56-0401031

Weather station "Sunny Times" with LCD screen, alarm clock, date display, thermometer and a removable stand on the back, with blue backlight

Packing: 20/40 pieces | Size: 14x8x2 cm

Branding:

☰ 40x10/30x30mm K1+H4+V1

☰ 60x45mm DP2+H2

✂ 40x10/22x22mm L1+H4



AAA/LR03/AM4

With a weather forecast

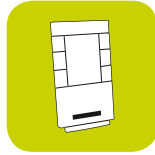

SHINY DAY 56-0401032

Weather station "Shiny Day" with LCD screen, aluminium front, alarm clock, date display, thermometer and a fold-out stand on the back

Packing: 20/40 pieces | Size: 13x2x13 cm | Material: Aluminium

Branding:

☰ 40x15mm K1+H4+V1

☰ 40x10mm DP1+H2

✂ 35x15mm L1+H4



AAA/LR03/AM4

With a weather forecast

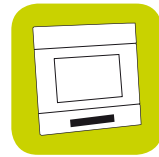

COMFORT 56-0401224

Thermometer "Comfort" with temperature display (min. + max.), measuring range 0-50°, with a suction cup and removable roof for various positioning

Packing: 50/200 pieces | Size: 9,7x8,9x2,5 cm

Branding:

☰ 35x10mm K1+H4





MARS 56-0401025

Indoor and outdoor thermometer "Mars" with digital alarm clock

Packing: 10/100 pieces |

Size: 7x2x13 cm

Branding:

☑ 30x15 mm K1+H3

☑ 30x15 mm L4+H3



AAA/LR03/AM4

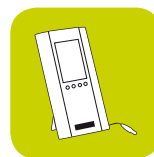

i Please find matching batteries for our articles on page 4.

MOON 56-0401020

Weather station "Moon" with weather forecast, alarm clock, date and moon phase

Packing: 10/60 pieces | Size: 8,5x6x17 cm

Branding:

☑ 25x10mm K1+H3

☑ 25x10mm L2+H3



AAA/LR03/AM4



👉 With a weather forecast



IN + OUT 56-0401233

Weather station "In + Out" with weather forecast, alarm, date and time display, thermometer and hygrometer, moon phase, outside sensor, 3 channels for perfect transmission, wall attachment on the back and stand for perfect hold

Packing: 10/20 pieces |

Size: 13x13x2,2/6,5x10x2,2 cm

Branding:

☑ 40x25/30x20 mm K2+H4

☑ 40x15/30x15 mm L2+H4



AAA/LR03/AM4



👉 With a hygrometer and thermometer



COLOUR 56-0401077

Projection alarm clock "Colour" with a red LED projector, weather forecast, alarm function, date and time display, hygrometer and thermometer (for °C and °F), lit up LCD screen - black display with coloured elements, fold-out stand on the back and a connection possibility for an adaptor (adaptor excluded)

Packing: 10/40 pieces | Size: 11x15x2cm

Branding:

30x10/15x30mm K2+H4



AAA/LR03/AM4



With a hygrometer and thermometer and a weather forecast

STEALTH 56-0401079

Weather station "Stealth" with an alarm function, date and time display, hygrometer and thermometer (for °C and °F) lit up LCD screen - black display with coloured elements, fold-out stand on the back, with a connection for an adaptor (adaptor excluded)

Packing: 20/40 pieces | Size: 14x8x1,8cm

Branding:

50x20mm K2+H4

60x45mm DP2+H2



AAA/LR03/AM4

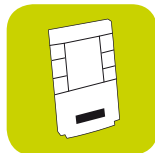

With a hygrometer and thermometer and a weather forecast

COLOUR 56-0401074

Weather station "Colour" with alarm function, date and time display, hygrometer and thermometer (for °C and °F), lit up LCD screen - black display with coloured elements and connection for an adaptor (adaptor excluded)

Packing: 10/40 pieces | Size: 8,5x12x4 cm

Branding:

30x10mm K2+H4



AAA/LR03/AM4



With a hygrometer and thermometer and a weather forecast





NEPTUNE 56-0401514

Radio controlled clock "Neptune" with analogue time display, automatic summer/winter time change, connected with DCF signal

Packing: 10 pieces | Size: Ø30x4 cm

Branding:

-  60x20mm DP2+H4
-  20x5mm L1+H4



AA/LR6/AM3

**PUNCTUAL**

Digital radio controlled clock "Punctual" with alarm clock, date and temperature display

Packing: 20 pieces | Size: 21,7x18x3cm

Branding:

-  50x20mm K1+H5
-  50x20mm L4+H5



AA/LR6/AM3



56-0401529
white



56-0401528
black

HALLEY

Wall clock "Halley" with analogue time display, white dial with protruding black numerals and black clock hands

Packing: 20 pieces | Size: Ø25,5x4,5 cm

Branding:

-  40x20mm L4+H4
-  40x20mm E1+H4



AA/LR6/AM3



56-0401554
magenta



56-0401551
black



56-0401552
light blue



56-0401553
green

 Please find matching batteries for our articles on page 4.

MERKUR 56-0401503

Wall clock "Merkur" with a removable dial and wide frame

Packing: 10 pieces | Size: Ø28x4,7 cm

Branding:

-  40x15mm K1+H3
-  40x35mm K1+H4
-  70x30mm DP2+H2
-  40x15mm L4+H3

1x
EXCL.

AA/LR6/AM3

**EASY TIME** 56-0401546

Wall clock "Easy time": with an analogue time display and wide frame

Packing: 10/20 pieces | Size: Ø25,4x3,2 cm

Branding:

-  45x13mm K1+H4

1x
EXCL.

AA/LR6/AM3



I like to beat the clock.



**VENUS** 56-0401217

Aluminium wall clock "Venus" with wide frame

Packing: 12 pieces | Size: Ø25x4,2 cm |

Material: Aluminium

Branding:

-  50x10mm K1+H4+V1
-  50x10mm L1+H4

1x
EXCL.

AA/LR6/AM3



SATURN 56-0401517

Rectangular wall clock "Saturn" with hygrometer and thermometer

Packing: 10 pieces | Size: 32x27x2,5 cm

Branding:

-  50x50mm K2+H4
-  65x50mm DP2+H2
-  65x50mm L4+H4



AA/LR6/AM3



 With a hygrometer and thermometer



**JUPITER** 56-0401220

Aluminium wall clock "Jupiter" with hygrometer and thermometer and a wide frame

Packing: 12 pieces | Size: Ø25x4,2 cm |

Material: Aluminium

Branding:

-  50x10mm K1+H4+V1
-  50x10mm L1+H4



AA/LR6/AM3



 With a hygrometer and thermometer



 Please find matching batteries for our articles on page 4.

APOLLO 56-0401537

Wall clock "Apollo" with weather station and weather forecast

Packing: 10 pieces | Size: 32x22x3,5 cm

Branding:

-  70x25mm K2+H2
-  60x40mm DP2+H2
-  90x15mm L4+H2



AA/LR6/AM3
AAA/LR03/AM4



 With weather forecast



SHOP  TOPS

SERVICE & QUALITY

OFFICE & BUSINESS

MUSIC & TIME

LIGHTS & TOOLS

SAVE & PRACTICAL



LIGHTS & TOOLS

➤ *„Here you can find small helpers for big things in life.“*





I like to roll up my sleeves and tackle my tasks! But I wouldn't be able to do so without my tools. My shopping cart contains handy helpers that assist me with my projects. Finding the middle way and the right tools is important to me. And lamps show my work in its true light.



SPOT 56-0403092

Elegant aluminium penlight "Spot" with on/off button, hand strap, packed in a metal box

Packing: 10/100 pieces |
 Size: 14,3xØ1-1,8cm/16,2x5,8x2,2cm |
 Material: Aluminium

Branding:
 40x10/30x7/7x7 mm K2+H3+V2
 140x40mm DP2+H2
 40x10/30x7/7x7 mm L1+H3
 40x50mm LR2+H3 360°

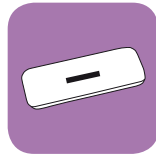

2x
 INCL.
 AAA/LR03/AM4



SPOT DOT 56-0403103

LED torch "Spot dot" with 8 white LEDs and red laser, rubber-coated ON/OFF button

Packing: 25/100 pieces | Size: Ø2,5x11 cm

Branding:
 10x6mm K2+H4+V2
 10x6mm L1+H4
 80x40mm LR2+H4 360°

3x
 EXCL.
 AAA/LR03/AM4

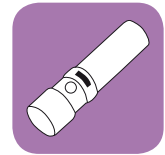

 With laser pointer

POWERFUL

LED torch "Powerful" with 9 bright white LED lights, ON/OFF button and a carrying loop, packed in a gift box

Packing: 20/120 pieces | Size: Ø2,8x9,5 cm |
 Material: Aluminium

Branding:
 10x8mm K1+H4+V2
 10x8mm L1+H4
 25x85mm LR2+H4 360°

3x
 INCL. 
 AAA/LR03/AM4



56-0699909
blue



56-0699903
black



56-0699908
red



56-0699910
green



DARK NIGHT

Torch "Dark Night" with 9 white LEDs, stable aluminium shaft, silver-coloured ring for logo application, rubber-coated ON/OFF button, hand loop

Packing: 20/80 pieces | Size: 11 x 3,4 cm |

Material: Aluminium

Branding:

☑ 30x10mm K2+H4+V1

☑ 30x10/13x6mm L1+H4

☑ 70x30mm LR2+H4 360°



AAA/LR03/AM4



56-0403102
green/silver



56-0403096
black/silver



56-0403100
blue/silver



56-0403101
red/silver

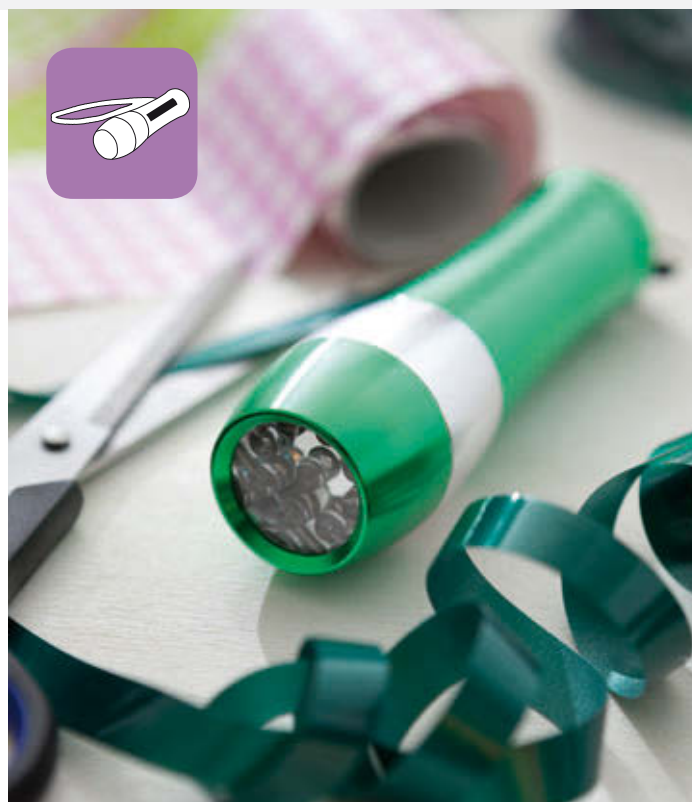

BRILLIANT 56-0699905

Penlight "Brilliant" with 3 bright white LED lights and an ON/OFF button

Packing: 20/120 pieces |

Size: Ø3,7/2,6 x 18 cm |

Material: Aluminium

Branding:

☑ 40x7 mm K1+H4+V2

☑ 40x7 mm L1+H4

☑ 50x50mm LR2+H4 360°



AA/LR6/AM3



i Please find matching batteries for our articles on page 4.

SILVER LIGHT 56-0699993

LED flashlight "Silver light" with 19 strong LEDs, ON/OFF, engraving area on the handle, top and bottom unscrewable, packed in a gift box

Packing: 20/100 pieces | Size: Ø4 x 13 cm |

Material: Aluminium

Branding:

☑ 30x5 mm K1+H2

☑ 30x5 mm L1+H2



AAA/LR03/AM4



i What does the term "LED" stand for? The light emitting diode, short LED, is an electronic semi-conductor part.

TURN ME 56-0699995

Ergonomically designed dynamo torch "Turn me" with ON/OFF button, 3 big white LED lights and fold-out dynamo crank to generate energy

Packing: 25/75 pieces |
Size: 15,5x6x4,5 cm

Branding:
☑ 40x10mm K1+H3
☑ 40x10mm L4+H3



☑ With a crank lever



ACTIVITY 56-0699991

Dynamo light "Activity" consists of a lamp with 3 LED lights, ON/OFF button, rubber-coated surface, fold-out crank lever to generate energy

Packing: 50/200 pieces |
Size: 8,4x4,6x2,6 cm

Branding:
☑ 18x25mm K2+H3



☑ With a crank lever

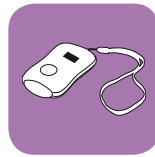

METAL HEAD

Torch "Metal head": with highly luminous 1 watt bulb, metal head, plastic casing, rubberized on/off switch, packed in gift box

Packing: 25/100 pieces | Size: Ø4x14,2 cm

Branding:
☑ 45x15mm K2+H4
☑ 12x15mm L4+H4

4x
EXCL. 

AAA/LR03/AM4



56-0403085
white



56-0403086
blue



56-0403087
red

CHARGE LIGHT

LED torch "Charge Light": rechargeable via USB, integrated battery with 40 mAh – end cap for USB plug with supporting loop, comfortable grip area and exposed advertising space

Packing: 50/200 pieces | Size: Ø3,2x12,7 cm

Branding:

☑ 30x8mm K1+H2

☑ 30x8mm L1+H2



56-0403156
black/silver

56-0403158
red/silver

56-0403157
blue/silver



WRITE LIGHT

Torch "Write Light" with integrated ballpoint pen: white LED light, on/off switch, lightweight plastic body with colourful elements, clip to attach, colour matching lanyard with safety closure – when cap removed, ballpoint pen (blue ink) with illuminated pen tip can be used

Packing: 100/400 pieces |

Size: Ø2,1 x 13 cm

Branding:

☑ 30x10mm K1+H2

☑ 20x10mm L4+H2



56-0403145
silver/magenta

👍 With writing light

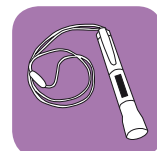

📌 Small torches might also be found with key rings on pages 144–148.



56-0403140
silver/blue



56-0403141
silver/red



56-0403142
silver/orange



56-0403143
silver/apple green



56-0403144
silver/yellow

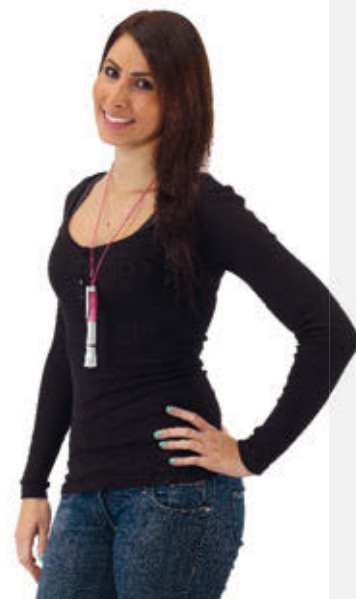

SUPER NOVA 56-0403095

Peak light "Super Nova", ideal for baseball caps and peak caps, for fastening on the peak, 5 white LEDs and 2 light modes, steady burning and flashing light, retractable

Packing: 50/200 pieces | Size: 8,3x6,2x1,7 cm

Branding:

25x5 mm K1+H4

25x5 mm L4+H4



2 light modes



ADJUSTABLE 56-0699988

Camping torch "Adjustable": 1 white LED with 3 different modes (steady, dimmed, and flashing light) and pull-out part for 360° light, usable as torch, rubber-coated on/off button, robust, lightweight plastic housing with practical handle that can be used to hang up, packed in gift box

Packing: 50/100 pieces | Size: Ø3,8x10-14 cm

Branding:

12x40/12x12 mm K1+H4+V1



AAA/LR03/AM4



TIEBACK

LED light "Tieback": looks like a light bulb, white LED light (1 Watt), pull the cord to switch on or off – ideal for garage, wardrobes and tent

Packing: 40/80 pieces | Size: Ø5,5x16 cm

Branding:

45x15 mm K1+H2

30x10 mm L1+H2



AAA/LR03/AM4



NEW

56-0403146
black/white



56-0403147
blue/white



56-0403148
green/white



BRIGHT HELPER

LED light "Bright Helper": with 16 white LEDs on front, 3 white LEDs on top, plastic casing, two fastening options: foldable hook and magnet on the back side, lateral on/off switch, in gift box

Packing: 25/100 pieces |

Size: 10,4x5,8x1,7 cm

Branding:

30x30mm K1+H4

30x30mm DP1+H2



AAA/LR03/AM4

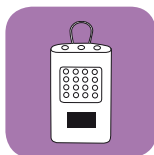

Magnetic



56-0403081
black



56-0403082
blue

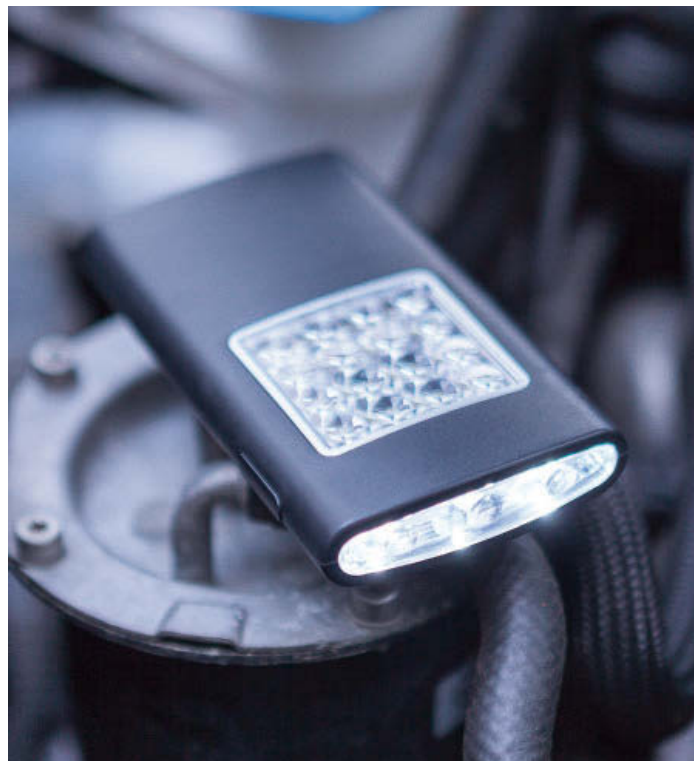

WORKSHOP 56-0403083

Work lamp "Workshop": with 20 powerful LEDs on the front side, 3 white LEDs on the side, rubberized casing, attachable via magnet and fold-out hook on the back side

Packing: 25/100 pieces | Size: 9,7x6,9x3,4 cm

Branding:

20x5mm K1+H2



AAA/LR03/AM4



Magnetic

NEW



Please find matching batteries for our articles on page 4.

WORKFLOW 56-0403090

LED work lamp "Workflow": with 24 bright white LEDs, on and off switch, metal plate for logos, rubberized housing with magnet for fastening and fold-out suspension hook on the backside

Packing: 10/50 pieces | Size: 21x5,8x2,3 cm

Branding:

30x15mm K2+H4+V1

30x15mm L1+H4



AA/LR6/AM3

Magnetic

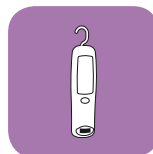



HEXAGON

LED stick light "Hexagon" with 3 white LEDs, rubber-coated ON/OFF button, easy to fix to different kinds of areas thanks to the hexagon attachment with magnet and adhesive pad

Packing: 30/60 pieces | **Size:** 25x6x2,2 cm | **Material:** Aluminium/ABS

Branding:

15x10mm K2+H4+V1

5x15mm L1+H4



AAA/LR03/AM4

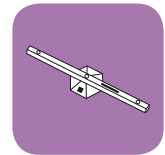

Versatile mounting options



56-0403111
silver



56-0403110
black



DOGS HELPER

Torch "Dogs Helper" with waste bags: white LED light, on/off twist mechanism, plastic body with slot in bone shape to pull out bags, twist closure with snap hook at the back of torch to replace waste bags

Packing: 100/200 pieces | **Size:** Ø4x 14,7 cm

Branding:

40x15mm K1+H2

40x15mm L4+H2



56-0403151
white/blue

10 waste bags included



56-0403150
white/black





56-0403152
white/red



56-0403153
white/apple green



TEDDY

Reflective key ring "Teddy"
Packing: 250/1000 pieces |
 Size: 12x5x0,5 cm
Branding:
 30x15mm K1+H2
 30x25mm DP1+H2



56-0402436
white

56-0402431
blue

VICTORY 56-0399003

Childrens safety vest "Victory" with reflectors
Packing: 100/300 pieces
Branding:
 40x20mm T1+H2
 EN13356:2009



 For children
EN13356

WHISTLER

Key chain "Whistler": with reflector and integrated whistle, snap hook made of plastic



Packing: 100/500 pieces |
 Size: 11x4,1x0,9 cm

Branding:
 20x20mm K1+H2
 20x15mm DP1+H2
 Ø15mm L4+H2



 Reflects



56-0402481
white

56-0402482
blue

56-0402483
red

56-0402484
orange

56-0402485
yellow





PANORAMA 56-0699906

Power LED light "Panorama" with 9 strong LED lights, rubber-coated ON/OFF button, carrying handle and fixture

Packing: 50/100 pieces |

Size: Ø2,9x9,5/8,4x5,5x4,7 cm

Branding:

☰ 25x10mm K1+H4

🔧 70x20mm LR2+H4 360°

3x
EXCL.

AAA/LR03/AM4

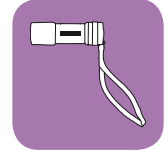

SEE YOU

Flexible snap band "See You" with metal spring

Packing: 100/500 pieces | Size: 32x3,2 cm

Branding:

☰ 40x12mm K1+H2

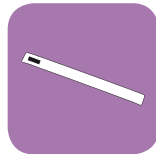

56-0402443
yellow

56-0402478
orange

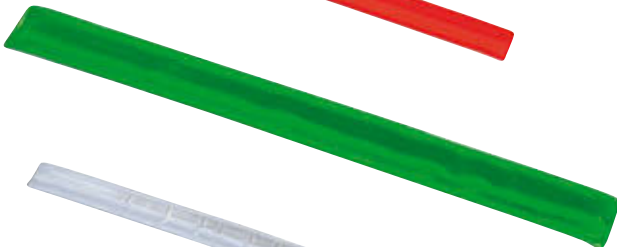
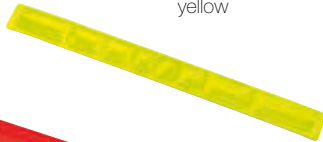

56-0402480
white

56-0402479
green

SMART LIGHTS 56-0699911

Torch set "Smart Lights" with 2 torches, one with red light and the other with white light, 2 light modes (steady light or flashing), rubber-coated ON/OFF button with elastic band to fasten on handles, packed in transparent box

Packing: 25/250 pieces |

Size: 5x3,5x1,5/9,5x4,5x2 cm

Branding:

☰ 40x10/20x20mm K1+H4+V1

2x
INCL.

👍 2 light modes



SHOWDOWN 56-0403132

Round blinking light "Showdown"

Packing: 100/600 pieces |

Size: Ø5 cm

Branding:

 23x23mm K1+H2

**VISIBLE** 56-0403133

Blinking light "Visible" shaped as a heart

Packing: 100/600 pieces | Size: Ø4 cm

Branding:

 15x15/25x10mm K1+H2

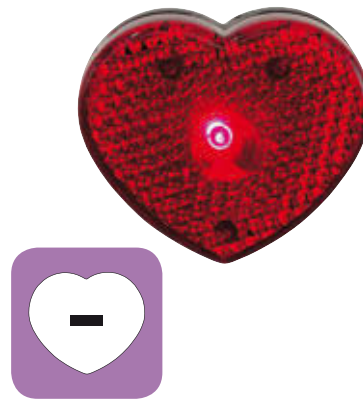
**HERE I AM** 56-0403131

Round reflector flashing light "Here I am" with a carabiner hook, 3 light modes, flickering, flashing, steady burning light

Packing: 30/300 pieces |

Size: Ø6,5x1,2 cm

Branding:

 20x20mm K1+H2

**FLASH CLIP**

Flashing light "Flash clip" 3 LED lights with 2 light modes (steady light or flashing), with solid fastening clip to e.g. jacket, belt, or luggage carrier

Packing: 50/200 pieces |

Size: 5,9x3x1,8cm

Branding:

 25x8mm K1+H2

 25x8mm L4+H2



56-0403134
red

56-0403135
transparent



BACKSTREET 56-0403130

Warning light "Backstreet": 8 red LED, with 3 different light modes (flickering light in intervals of 3, surround light, blinking light), on/off switch, transparent plastic casing with rubber-coated sheathing, fastening via snap hook

Packing: 50/200 pieces | Size: Ø6,4x2,4 cm

Branding:

☰ Ø25 mm K1+H2

✂ 10x10mm L1+H2

2x
INCL.



👉 3 light modes



EXPEDITION 56-0699992

Head lamp "Expedition" with 5 strong LED lights, light flashes or burns normally, ON/OFF button, adjustable light and adjustable nylon head band

Packing: 50/200 pieces | Size: 5,5x4x2,2 cm

Branding:

☰ 10x5/4x20mm K1+H4

✂ 10x5/4x20mm L4+H4

3x
EXCL. 📦

AAA/LR03/AM4

👉 For the evenings



OVERVIEW 56-0699987

Headlamp "Overview": 3 different light modes (strong, normal, and blinking light), on/off switch, range of light approx. 8 m, lamp with movable angle of inclination of up to 90 degrees as well as adjustable and elastic headband

Packing: 25/100 pieces | Size: 5,5x4x2,2 cm

Branding:

☰ 10x10mm K2+H4

✂ 20x5mm L1+H4

3x
EXCL. 📦

AAA/LR03/AM4



👉 3 light modes

JOGGER

Flashing light "Jogger" for the upper arm: 2 LED lights with 2 light modes (steady light or flashing), transparent frosted band with black Velcro closure strap and reflective stripes for high visibility

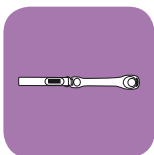

Packing: 50/200 pieces |

Size: 19,2x3,7x1,3cm

Branding:

2x 20x10mm K1+H2

2x 20x10mm L4+H2



2 light modes



56-0403138
white/transparent

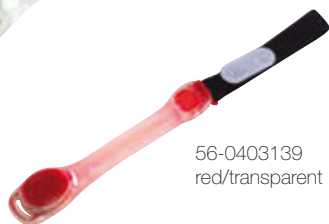

56-0403139
red/transparent

**RUNNER** 56-0403149

Shoe light "Runner": integrated light-band with 2 light modes (blinking and continuous light), with 2 white LED, on/off switch on the side – ideal for jogging, walking, and hiking

Packing: 100/400 pieces | **Size:** 9x6,4x3cm

Branding:

10x10mm K1+H2



without decoration

NEW



2 light modes

Find additional items for sports and recreational activities on pages 348-352.

SEE ME

Running belt "See Me", splash-proof: outside with opening for headphones and reflector for good visibility in traffic, inside with zip, adjustable and elastic belt with snap hook – ideal for jogging, walking, and hiking

Packing: 50/200 pieces | **Size:** 24x4,2cm

Branding:

80x15mm F1+H2

80x15mm T1+H2

NEW

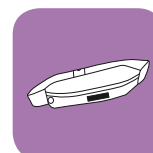

56-0404401
yellow/black

without decoration

Reflects



56-0404400
black



56-0404402
orange/black



HERO

Safety/emergency vest "Hero" with reflector stripes and Velcro fastener on the front, packed in a bag with carrying handle

Packing: 100 pieces | **Size:** one size

Branding:

80x80mm T1+H6

60x40mm T1+H6

160x240mm T2+H6

EN ISO 20471:2013



56-0399006
yellow



EN ISO 20471:2013



56-0399010
orange



In accordance
with the latest
safety standards

MAN-POWER 56-0399002

Car tool set "Man-power" with warning vest, 2 gloves, tow rope, jump leads, torch, tyre pressure tester, isolation tape, 2 screwdrivers, wrench, wire test screwdriver, pliers, 10 fuses, 20 cable ties, extendable L key and nuts, 1 booster-cable

Packing: 4 pieces | **Size:** 43x33x9 cm

Branding:

105x105 mm T2+H6



2x
EXCL.



Vest: EN ISO 20471:2013

D/LR20/AM1



MOTORWAY 56-0403136

Emergency warning light "Motorway", waterproof: with 5 LED light modes (steady light only at the top, revolving, flickering, flashing, steady light), on and off switch, in partly rubberized transparent housing with magnet and foldable hooks at the bottom

Packing: 25/100 pieces | **Size:** Ø9,9x3,5 cm

Branding:

20x7 mm E2+H2

3x
EXCL.



5 light modes

AAA/LR03/AM4





Safety is important to me.   

SAFETY 56-0380009

Emergency hammer "Safety": with white LED light, on/off switch on handle, integrated cutter, including rubber-coated cap for the tip of the hammer

Packing: 20/80 pieces | **Size:** 13,5x7,5x2cm |
Material: ABS/Metal

Branding:

-  30x15mm K1+H2
-  30x15mm DP1+H2
-  30x15mm L4+H2



 **NEW**

9IN1 56-0382019

Screwdriver set "9in1" with hammer, 7 foldout shafts: torx, cross and slot screw heads, and small flashlight with 3 LED in the middle of the handle, on and off switch located on the belt clip, packed in a black box

Packing: 40 pieces | **Size:** 15x10,5x4cm

Branding:

 15x20mm K2+H4



AAA/LR03/AM4

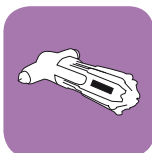

 **With integrated flashlight**



BREAK THROUGH 56-0380000

Emergency hammer "Break Through" for more safety! With a belt cutter, knob and holder to attach to a wall, packed in a box

Packing: 100 pieces | **Size:** 17x6,5x4,2cm

Branding:

-  60x8mm D1+H4
-  40x5mm K2+H4
-  40x5mm L5+H4



ARRIVAL 56-0407096

Ice scraper "Arrival" with built-in parking meter

Packing: 100/200 pieces |

Size: 15,5x12x0,6cm

Branding:

☰ 35x40mm K1+H2

☰ 130x90mm DP2+H2

☰ 70x80mm S1+H2

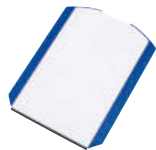
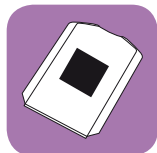
**NAVI** 56-0407100

Mobile phone holder "Navi" for the car with suction cup to fasten to the windscreen, adjustable brackets (approx. 10 cm) and adjustable joint for the ideal position, suitable for most current smartphones, packed in a box

Packing: 25/75 pieces | Size: 14xØ5,8cm**Branding:**

☰ 15x10mm K2+H4

**DISTRESS**

Emergency pocket knife "Distress" with integrated belt cutter, emergency hammer, blade and clip, packed in gift box

Packing: 12/120 pieces | Size: 15,3x9,5x1,1 cm**Branding:**

☰ 40x6mm K1+H4+V2

☰ 40x6mm L1+H4

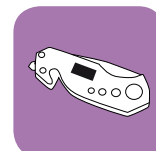
56-0301136
red/black56-0301134
blue/black56-0301135
green/black56-0301137
orange/black

SHADY 56-0609080

2 piece window sun shade set "Shady" for the car packed in a bag

Packing: 120 sets | Size: 43x38cm

Branding:

☞ 230x80mm T2+H5

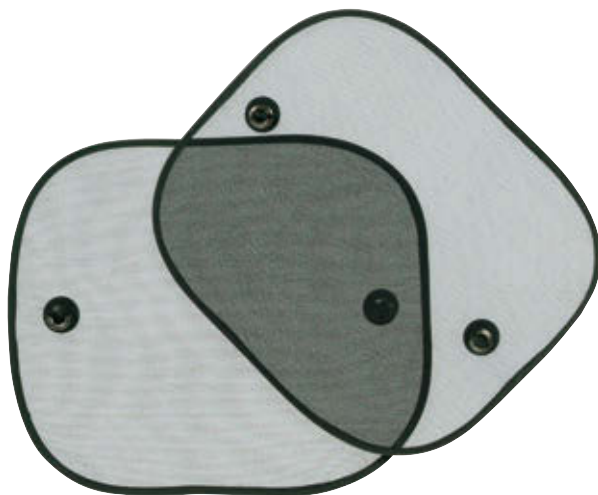
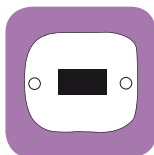
**TRAVEL
COMPANION** 56-0309047

High quality car coat hanger "Travel companion" with universal fasteners

Packing: 10 pieces | Size: 49x23cm | Material: chrome-plated steel

Branding:

☞ 50x15mm K1+H6

☞ 50x15mm L2+H6

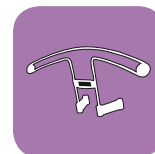

SO FREE 56-0407097

Windscreen cover "So free" with suction cups packed in a bag with draw string and plastic stopper

Packing: 60/120 pieces | Size: 200x70 cm

Branding:

☞ 120x50mm S2+H4

☞ 280x280mm S3+H5

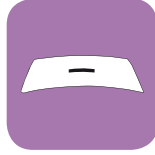

I have a handle on winter.

**CLEAR SIGHT**

Ice scraper "Clear sight" with warm glove

Packing: 50/100 pieces | Size: 28x16x1,5 cm

Branding:

☞ 45x10mm K1+H2+V2

☞ 80x140mm T2+H2



56-0407091
blue

XXL
print



56-0407095
grey

CLEANER

Microfibre cloth "Cleaner": highly absorbent and quick drying, with soft surface structure, in colour-coded mesh bag with pullable cord and plastic stopper

Packing: 50/100 pieces |

Size: 31,5x31 / Ø 13,5x16,5 cm |

Material: Polyester

Branding:

☞ 65x35mm T1+H4

☞ 280x280mm N1+H4

Microfibre



56-0605001
black/white



56-0605002
blue



 **Highly absorbent and quick drying**



56-0605003
orange



SHOWER 56-0609032

Car cleaning set "Shower": consists of 1 net sponge, 1 universal sponge, and 1 microfibre cloth, in transparent zipper bag

Packing: 12 pieces | Size: 24x24x7 cm

Branding:

- 40x20mm E1
- 80x40mm E3

**AU LAIT**

Doubled-walled travel mug "Au Lait": made of stainless steel on the inside and outside, different coloured screwable plastic lid with drinking opening, coloured rubber ring for a better grip and rubberized stand for good surface adhesion, approx. 380 ml capacity, packed in a gift box

Packing: 28 pieces | Size: Ø6,7x18,5 cm |

Material: Stainless Steel

Branding:

- 25x25mm K2+H4+V2
- 180x40mm LR3+H4 360°
- 25x25mm L2+H4



Approx. 380 ml



56-0304133
black/silver



56-0304134
green/silver



56-0304135
blue/silver



56-0304136
orange/silver



56-0304137
lilac/silver

For more vacuum flasks
see page 196-200.

GUARDIAN CARRY 56-0405266

First Aid kit "Guardian Carry" includes plasters, bandage, cloth, pads, plaster strips, safety pins, hygienic moist cloths, small pair of scissors, packed in a zip bag with belt loop

Packing: 50/100 pieces | **Size:** 15x9,2x4cm

Branding:

☰ 45x70mm T1+H5

**GUARDIAN POUCH** 56-0405269

First Aid kit "Guardian Pouch" with plasters, 2 bandages, cloth, pads, plaster strips, safety pins, hygienic moist cloths, small pair of scissors, packed in zip bag

Packing: 40/80 pieces | **Size:** 15x10x5cm

Branding:

☰ 70x45mm T1+H5

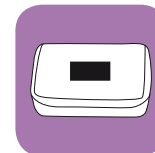
**GUARDIAN BOX** 56-0405264

First Aid kit "Guardian Box" includes bandage, cloth, pads, plaster strips, safety pins, hygienic moist cloths, small pair of scissors, dynamo torch, packed in a first aid box

Packing: 10/40 pieces | **Size:** 18x13x6,5cm

Branding:

☰ 40x40mm K2+H2



GUARDIAN PROOF 56-0405263

First Aid kit "Guardian Proof" includes plasters, bandage, pads, hygienic moist cloths, small pair of scissors, packed in water-resistant box with carrying handle

Packing: 50/100 pieces |

Size: 13,5x9,5x3,5 cm

Branding:

☒ 35x25 mm K1+H2

☒ 35x25 mm DP1+H2



*First Aid –
no problem for me.*

**GUARDIAN MINI** 56-0405268

Mini First Aid kit "Guardian Mini" with 5 plasters, packed in a plastic box

Packing: 100/500 pieces | **Size:** 8x3,5x1,5 cm

Branding:

☒ 35x15 mm K1+H2

☒ 70x30 mm DP2+H2

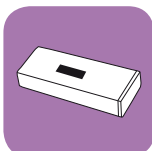
**GUARDIAN POCKET** 56-0405265

First Aid kit "Guardian Pocket" with plasters and hygienic moist cloths, packed in a pouch with key ring and Velcro fastener

Packing: 250/500 pieces | **Size:** 11,2x7 cm

Branding:

☒ 40x15 mm K2+H2

☒ 40x15 mm T1+H2



SCREW FINDER 56-0381016

19 piece screwdriver set "Screw finder" with magnetic holder and built-in bit and nut holder in the handle

Packing: 25/50 pieces | Size: 18,5x3,5x3 cm

Branding:

🔧 30x7,5 mm K1+H3+V1

🔧 30x7,5 mm L1+H3

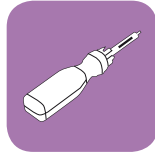

 Magnetic

**COMPACT** 56-0381050

24 piece tool set "Compact" includes 6 different screwdrivers, pliers, tweezers, sockets and various bits, packed in a pouch with a zip

Packing: 30 pieces | Size: 17,5x9,8x3,7 cm |

Material: 600D Polyester

Branding:

🔧 40x30mm T1+H3

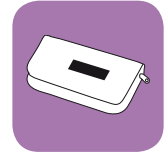
**MASTERKIT** 56-0399013

42 piece tool set "Masterkit" with a red and black design, packed in a case

Packing: 5 pieces | Size: 33x25,5x7 cm

Branding:

🔧 70x25 mm L5+H2

📦 40x20 mm E1



8 IN 1 56-0382020

Screwdriver set "8in1" with 7 foldable torx wrenches, slotted, and crosstip screwdrivers, integrated torch and 1 LED to light up workspace, on/off switch, belt clip, packed in a gift box

Packing: 50 pieces | Size: 15,5x4,9x3 cm

Branding:

25x9mm K2+H4+V1



AAA/LR03/AM4

**6 IN 1**

Screwdriver set "6 in 1": with 5 foldable torx wrenches, slotted and crosstip screwdrivers, integrated torch with 4 LED lights, on/off switch, clip, packed in a gift box

Packing: 60/120 pieces | Size: Ø3x9/15,5 cm

Branding:

25x7 mm K1+H4



AAA/LR03/AM4

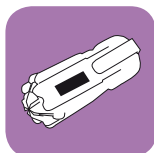

56-0382017
black/red



56-0382018
black/yellow





CRAFT 56-0399007

25 piece tool set "Craft" with torch

Packing: 25 pieces | Size: 20x13x10 cm

Branding:

35x15mm K1+H2+V1



AA/LR6/AM3



SIMPLE 56-0381044

14 piece tool set "Simple" includes a screwdriver with a rubber-coated handle and various bits and sockets, packed in a metal box with a zip closure

Packing: 25/50 pieces | Size: 20,5x7x3 cm

Branding:

40x15mm K1+H4+V1

40x15mm L1+H4



ROLL FORWARD 56-0381038

24 piece tool set "Roll forward" packed in a box with a wheel design

Packing: 20 pieces | Size: Ø16x5,8 cm

Branding:

30x30mm K2+H4+V1

30x30mm L4+H4



ASSISTANT

Multifunction hammer "Assistant" with 8 tools: claw hammer with plier function, cross and slot screwdrivers, bottle opener, file, knife, and saw – shiny metallic handle with rubber-coated side surface, in nylon pouch with belt loop at the back

Packing: 10/40 pieces | **Size:** 13,5x7x2,4 cm

Branding:

🔪 10x12mm K2+H4+V2

🔪 10x12mm L1+H4



56-0381040
blue



56-0381042
silver



56-0381041
red



CLOCK OFF 56-0382016

Friday hammer "Clock off" with hammer on the one side and bottle opener on the other side with plastic handle, packed in a tray

Packing: 24 pieces | **Size:** 24,8x11,4x3,6 cm

Branding:

🔪 15x10/7x40mm L1+H4



👉 2 in 1



MULTI TALENT 56-0381043

Multifunctional hammer "Multi talent" with 6 functions, shiny metallic handles with partially rubber-coated surface, packed in a nylon bag

Packing: 25/50 pieces | **Size:** 13,5x7,5x1,7 cm

Branding:

🔪 30x10mm K1+H5+V2

🔪 30x20mm T1+H5

🔪 30x10mm L1+H5

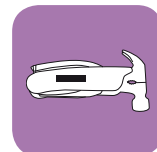



MICRO

Bit-Set "Micro" with 8 different kinds of bits, bits are located on the inside with an unscrewable lid, magnetic tip to hold the bits, packed in gift box

Packing: 50/200 pieces | **Size:** Ø 1,4x10,7 cm | **Material:** Metal/Aluminium

Branding:

-  35x7 mm K2+H2+V1
-  35x6 mm L1+H2



56-0399018
black



56-0399017
blue



56-0399019
red

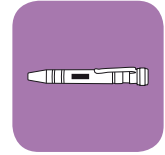



PACKAGE

Cutter knife "Package": in transparent plastic case with coloured end piece – blunt blades can be safely cut out with the end piece

Packing: 50/500 pieces | **Size:** 15,5x3x1,4 cm

Branding:

-  8x40mm K1+H2
-  100x10mm DP1+H2



56-0399034
transparent/yellow

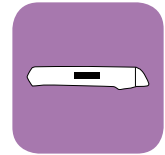

56-0399030
transparent/black



56-0399031
transparent/blue



56-0399032
transparent/green



56-0399033
transparent/red

ALL TOGETHER

11 piece pocket knife "All together" with pair of scissors, knife, 1 large and 1 small saw, can opener, bottle opener, corkscrew, nail file, pricker, hole maker and screwdriver, packed in gift box

Packing: 25/100 pieces | **Size:** 10,5x3x2,5cm | **Material:** Stainless Steel

Branding:

-  40x6mm K1+H4+V2
-  40x6mm DP1+H2
-  40x6mm L1+H4



56-0301131
orange

 For more pocket knives see page 324-327.



56-0301130
blue



56-0301132
silver



56-0301133
green



DO IT 56-0399014

Tool belt bag "Do it" with adjustable belt bag, 3 screwdrivers, 3m measuring tape, cutter, carpenter's pencil and a black marker

Packing: 20 pieces | Size: 25x30x7 cm

Branding:

☑ 15x5mm K1+H3+V1

☑ 70x40mm T1+H2



ENGINEER 56-0399015

17-piece tool set "Engineer" packed in a silver case

Packing: 5 pieces | Size: 31x24x6,4cm |

Material: Aluminium

Branding:

☑ 40x15mm L2+H2



MEASURE 56-0382015

Spirit level "Measure" with 2 spirit levels and loop to hang up

Packing: 40/80 pieces | Size: 20x5x2 cm |
Material: Aluminium

Branding:

-  40x10mm K2+H5
-  40x10mm DP1+H2
-  40x10mm L2+H5

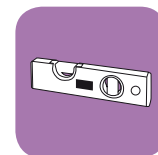
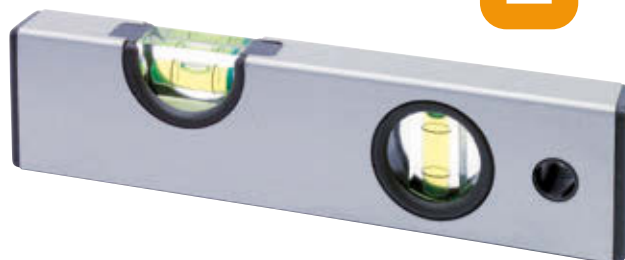

 20 cm



*Handy helpers
for my projects.*

**CARPENTER** 56-0382011

Extendable spirit level "Carpenter" with cm and inch measuring units

Packing: 25/50 pieces | Size: 56-80,5x5x2 cm |
Material: Aluminium

Branding:

-  40x10mm K1+H2
-  50x10mm DP1+H2
-  80x10mm L2+H2

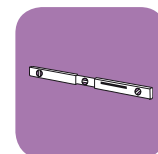

GUM 56-0403010

Measuring tape "Gum", 1m, rubber-coated wheel design with key ring

Packing: 50/250 pieces |

Size: 10,5x4x1,2 cm

Branding:

☑ Ø20mm K1+H2+V1



1m

**THEMSE** 56-0382012

Spirit level "Themse" with key chain

Packing: 100/1000 pieces |

Size: 4,2x1,5x1,5 cm

Branding:

☑ 28x8mm K1+H2

☑ 25x6mm DP1+H2

**HINGED** 56-0382021

Multi-tool "Hinged" with 17 application possibilities: spirit level, fold-out screwdriver with 12 different bits, LED light, measuring tape 1 m, hammer, in gift box

Packing: 25/50 pieces | Size: 13,5x3x4,5 cm

Branding:

☑ 40x3mm K1+H2

☑ 80x5mm L4+H2

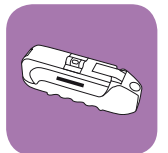

WORKMAN

Measuring tape "Workman" with clip and carrying loop in rubber body with an automatic stopper, 3m

Packing: 30/120 pieces | Size: Ø7,5x3cm

Branding:

☰ 15x15mm K1+H2+V1

☒ 15x15mm L4+H2

3m



3m



56-0403221
grey/blue

56-0403225
black/yellow

EMPLOYEE

Measuring tape "Employee" with clip and carrying loop in rubber body with an automatic stopper, 5m

Packing: 30/120 pieces | Size: Ø8,5x3,5cm

Branding:

☰ 15x15mm K1+H2+V1

☒ 15x15mm L4+H2

5m



5m



56-0403231
grey/blue

56-0403235
black/yellow



BASIC I

56-0403202

Measuring tape "Basic I" with clip, carrying loop and yellow measuring tape in cm, rubber-coated surface, automatic stopper, 3m

Packing: 20/120 pieces | Size: 6,4x6,1x3,8cm

Branding:

☰ 15x15mm K1+H2+V1

☒ 15x15mm L4+H2

3m



3m

BASIC II

56-0403203

Measuring tape "Basic II" with clip, carrying loop and yellow measuring tape in cm, rubber-coated surface, automatic stopper, 5m

Packing: 20/80 pieces | Size: 7,4x6,9x2,8cm

Branding:

☰ 15x15mm K1+H2+V1

☒ 15x15mm L4+H2

5m

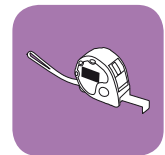

5m

ELEMENTAL

Measuring tape "Elemental": yellow tape made of steel, automatic with stopper, belt clip, and carrying loop, 3 m

Packing: 50/100 pieces |
Size: 6,5x6,4x3,2 cm

Branding:

-  Ø35 mm K1+H2
-  40x30 mm DP1+H2
-  40x30 mm L5+H2

 3m

 3m

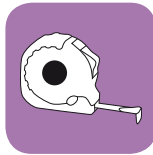
**ELEMENTAL**

Measuring tape "Elemental": yellow tape made of steel, automatic with stopper, belt clip, and carrying loop, 5 m

Packing: 20/60 pieces | Size: 7,2x7x3,8 cm

Branding:

-  Ø35 mm K1+H2
-  40x30 mm DP1+H2
-  40x30 mm L5+H2

 5m

 5m

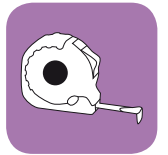
**BUILDER** 56-0403212

Measuring tape "Builder": with roll up function, automatic with stopper, clip on the back, in rubberized body, 3m

Packing: 12/120 pieces | Size: 7x7x3 cm

Branding:

-  Ø25 mm K1+H2

 3m

 3m

**BUILDER** 56-0403213

Measuring tape "Builder": with roll up function, automatic with stopper, clip on the back, in rubberized body, 5m

Packing: 12/120 pieces | Size: 8x7,3x3 cm

Branding:

-  Ø25 mm K1+H2

 5m

 5m



NOTY 56-0403050

Measuring tape "Noty" with spirit level, note pad and pen, 2m

Packing: 30/120 pieces |
Size: 7,9x6x2,4 cm

Branding:

☰ 30x30mm K1+H2
☰ 35x35mm DP1+H2

 2m

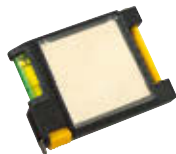
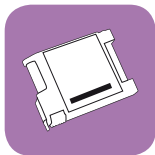
**SMALLSIZE** 56-0407116

Key ring "Smallsize" with measuring tape, 1m

Packing: 300/1200 pieces | Size: 4x4 cm

Branding:

☰ 30x30mm K1
☰ 40x40mm DP2+H2

 1m

**TOPY** 56-0403207

Measuring tape "Topy": with white tape in cm and automatic stopper, 3m

Packing: 20/200 pieces |
Size: Ø6,5x2 cm

Branding:

☰ Ø57-58mm D1+H4
☰ Ø30mm K1+H4

 3m

 3m

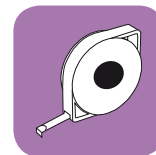

LABOUR

Measuring tape "Labour" with clip and carrying loop, with a rubber body, 3m

Packing: 30/120 pieces | Size: 6,5x6x2,5cm

Branding:

☑ 25x15/15x20mm K1+H2+V1

☑ 15x15mm L4+H2

 3m

**WORKER**

Measuring tape "Worker" with clip and carrying loop, with a rubber body, 5m

Packing: 30/60 pieces | Size: 7,5x6,5x3cm

Branding:

☑ 25x15/20x20mm K1+H2+V1

☑ 15x15mm L4+H2

 5m

**FLIPFLOP** 56-0403060

Measuring tape "Flipflop", retractable, 1,5m

Packing: 50/250 pieces | Size: Ø5x1,8cm

Branding:

☑ 25x25mm K1+H2

☑ Ø30mm DP1+H2

 1,5m

**BROTHER** 56-0403206

Measuring tape "Brother" with clip, white measuring tape, automatic stopper, 3m

Packing: 20/120 pieces |

Size: 5,5x5,5x2,8cm

Branding:

☑ 30x15mm K1+H2+V1

☑ 30x15mm L4+H2

 3m



SERVICE & QUALITY

OFFICE & BUSINESS

MUSIC & TIME

LIGHTS & TOOLS

SAVE & PRACTICAL



SAVE & PRACTICAL

➤ *„Everything here is practically top-notch.“*

Let's stroll through the town! Being a bargain hunter, I can put to good use my key skills and find the best offers. In my purse, all banknotes are well sorted and ready to hand when it's time to pay.



CRUISER 56-0407845

Key ring "Cruiser"

Packing: 50/200 pieces | Size: 4,7x2,2x0,3cm

Branding:

☰ 20x8mm K1+H2+V2

☑ 20x8mm L1+H2

**AIRCRAFT** 56-0407833

Key ring "Aircraft"

Packing: 50/200 pieces |

Size: 4,5x4,5x0,4cm

Branding:

☰ 18x3mm K1+H4+V1

☑ 18x3mm L1+H4

**MOONWALK** 56-0407832

Key ring "Moonwalk"

Packing: 50/200 pieces |

Size: 9x3cm

Branding:

☰ 13x13mm K1+H4+V1

☑ 13x13mm L1+H4

**CAR** 56-0407831

Key ring "Car"

Packing: 50/200 pieces |

Size: 4,8x2,5x0,4cm

Branding:

☰ 15x12/30x6mm K1+H4+V1

☑ 15x12/30x6mm L1+H4

**TIE SHIRT** 56-0407819

Key ring "Tie Shirt"

Packing: 50/200 pieces |

Size: 8,5x4x0,6cm

Branding:

☰ 8x15mm K1+H4+V1

☑ 8x15mm L1+H4



SCREEN 56-0407830

Key ring "Screen"

Packing: 50/200 pieces | Size: 3,5x3,2x0,4 cm

Branding:

 13x13mm K1+H4+V1

 16x18mm L1+H4
**CHABLIS** 56-0407834

Key ring "Chablis"

Packing: 50/200 pieces | Size: 9x3cm

Branding:

 15x8mm A2+H4

 15x8mm K1+H4+V1

 15x8mm L1+H4
**HATTRICK** 56-0407820

Key ring "Hatrick"

Packing: 50/200 pieces | Size: 8,3x4x0,6cm

Branding:

 8x15mm K1+H4+V1

 8x15mm L1+H4
**CAT** 56-0407815

Key ring "Cat"

Packing: 50/200 pieces |

Size: 8,5x2x0,5cm

Branding:

 8x15mm K1+H4+V1

 8x15mm L1+H4
**PIG** 56-0407818

Key ring "Pig"

Packing: 50/200 pieces |

Size: 9x3cm

Branding:

 15x8mm K1+H4+V1

 15x8mm L1+H4
**DOG** 56-0407816

Key ring "Dog"

Packing: 50/200 pieces | Size: 9,7x3x0,5cm

Branding:

 8x15mm K1+H4+V1

 8x15mm L1+H4

TEAMPLAYER 56-0407607

Key ring "Teamplayer" shaped as a football player

Packing: 50/250 pieces | **Size:** 7x3 cm |**Material:** Metal**Branding:**

☰ 15x8mm K1+H2+V1

✍ 15x10mm L1+H2

*My door opener to success.***IN-HOUSE** 56-0407821

Key ring "In-house"

Packing: 50/250 pieces |**Size:** 7,2x4,8x0,7 cm | **Material:** Metal**Branding:**

☰ 25x12mm K1+H2+V1

✍ 25x12mm L1+H2

**LIMOUSINE** 56-0407822

Metal key ring "Limousine"

Packing: 50/250 pieces |**Size:** 6,3x4,2x0,5 cm | **Material:** Metal**Branding:**

☰ 20x8mm K1+H2+V1

✍ 20x8mm L1+H2

**TACK** 56-0407811

Key ring "Tack" with an integrated clock with Roman numerals

Packing: 50/200 pieces | **Size:** 8,3x3,5x0,8 cm**Branding:**

☰ 9x5 mm K1+H2+V1

✍ 9x5 mm L1+H2



BELLY BEAR 56-0407929

Key ring "Belly Bear" with moveable paws: arms and legs

Packing: 50/200 pieces | **Size:** 9,3x2,5x1,7 cm | **Material:** Zinc Alloy

Branding:

☑ 14x4 mm L4+H2

 With moveable paws

**1 EURO HOLDER** 56-0407540

Key ring "1 Euro holder", ideal for shopping

Packing: 50/250 pieces |

Size: 7,5x3x0,5cm | **Material:** Metal

Branding:

☑ 20x6mm K1+H2+V1

☑ 15x9mm L1+H2

without coin

**MONEY** 56-0407544

Metal key ring "Money" with a coin in matt design

Packing: 50/250 pieces |

Size: 7,2x3,5x0,45cm | **Material:** Metal

Branding:

☑ 17x5mm K1+H2+V2

☑ 17x5mm L1+H2

**TED** 56-0407919

Key ring "Ted"

Packing: 50/200 pieces |

Size: 7,5x3,5cm | **Material:** Zinc Alloy

Branding:

☑ Ø18mm D1+H2

☑ Ø18mm K1+H2+V2

☑ Ø18mm L1+H2





I'll hang on to this.



TERRA 56-0407550

Key ring "Terra" with turnable inner area

Packing: 50/250 pieces | Size: 7xØ3,5 cm |

Material: Metal

Branding:

☰ Ø10mm K1+H2+V1

☑ Ø20mm L1+H2



CHAIN 56-0407808

Key ring "Chain" with 4 removable rings, carabiner hook and a chain

Packing: 50/200 pieces | Size: 30x3x3cm

Branding:

☰ Ø20mm D1+H2

☑ Ø20mm K1+H2+V1

☑ Ø20mm L1+H2



THASSOS 56-0407807

Key ring "Thassos"

Packing: 50/250 pieces |

Size: 8,5x3,5x1 cm | Material: Metal

Branding:

☰ 20x6mm K1+H2+V1

☑ 20x7mm L1+H2



HANG ON

Key ring "Hang on": with colourful leatherette strip

Packing: 50/250 pieces | Size: 8,5x3,2cm |

Material: Zinc Alloy

Branding:

☑ 25x5mm K1+H2+V2

☑ 25x8mm L1+H2



56-0407922
silver/red



56-0407920
silver/blue



56-0407921
silver/black



56-0407923
silver/green



This is a key moment.

**SPINNING CLOVER LEAF
SPINNING HEART**

Key ring "Spinning Clover Leaf + Spinning Heart" with spinning central part

Packing: 50/200 pieces |

Size: 6,6x3,6x0,4cm

Branding:

☑ 10x10mm K2+H4+V1

☑ 10x10mm L1+H4



56-0407930
Clover Leaf



56-0407931
Heart



 Spinning central part

LITTLE LIGHTENING

LED torch "Little Lightening" with a key ring, 3 bright LED lights and a rubber-coated ON/OFF button

Packing: 50/400 pieces | Size: 9,5x2,1x1,5 cm | Material: Aluminium

Branding:

20x8mm K1+H4+V1

50x8mm L1+H4



56-0699901
red



56-0699900
black



56-0699899
silver



56-0699902
blue

FLARE

Key ring "Flare" with LED torch and rubber-coated ON/OFF button

Packing: 50/400 pieces | Size: Ø1,5x7 cm | Material: Aluminium

Branding:

20x8mm K1+H4+V1

40x25mm LR2+H4 360°



56-0407853
silver/blue



56-0407852
silver



56-0407854
silver/black



56-0407855
silver/red

OPENEND 56-0407841

Practical bottle opener "Openend" with key ring

Packing: 50/250 pieces | Size: 8,4x3,5x0,5 cm | Material: Metal

Branding:

20x10mm K1+H2+V1

30x12mm L1+H2



FLUTE

Key chain "Flute": with aluminium whistle and key ring

Packing: 50/400 pieces | Size: Ø1,2x6,2 cm | Material: Aluminium

Branding:

25x4 mm K1+H2+V2

25x5 mm L1+H2



56-0407918
lilac



56-0407913
silver



56-0407914
black



56-0407915
blue



56-0407916
red



56-0407917
green



56-0407924
orange



OPEN

Bottle opener "Open" with key ring

Packing: 200/1000 pieces |

Size: 5,6x1x0,3cm |

Material: Aluminium

Branding:

☑ 25x4 mm K2+H2

☑ 25x4 mm L1+H2

**STARLIGHT** 56-0699997

LED mini torch "Starlight" with blue light on a key ring

Packing: 50/200 pieces | Size: 11xØ1,5 cm | Material: Aluminium

Branding:

☑ 30x8 mm K1+H2+V1

☑ 35x7 mm L1+H2



for 3 button cells, 3 extra

**TASK**

LED torch "Task" with key ring, 3 LED lights with integrated bottle opener, rubber-coated ON/OFF button

Packing: 50/400 pieces |

Size: Ø1,7x7,2cm | Material: Aluminium

Branding:

☑ 20x8mm K1+H4+V2

☑ 20x8mm L1+H4



DOUBLE OPEN

Key chain "Double Open": with pull-out holder for a smartphone, integrated bottle opener and key ring

Packing: 50/500 pieces | Size: 12,8x1,6x1,6cm

Branding:

-  50x10mm K2+H2
-  50x10mm DP1+H2
-  50x10mm L1+H2



SMART CLEAN

Key chain "Smart Clean": with touchscreen tip for smartphones and tablets on one side and display cleaner on the other side, including key ring

Packing: 100/500 pieces | Size: 10x1,9x0,9cm

Branding:

-  15x8mm K1+H2
-  15x8mm DP1+H2
-  20x10mm L1+H2

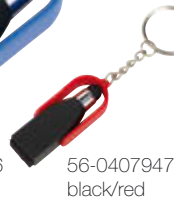



NOVA 56-0407013

LED torch "Nova" with white light, button and key ring, packed in a black box

Packing: 50/250 pieces | Size: 7,6x2,5x1,8cm

Branding:

-  10x35/10x30mm K1+H2
-  10x35/10x30mm L4+H2

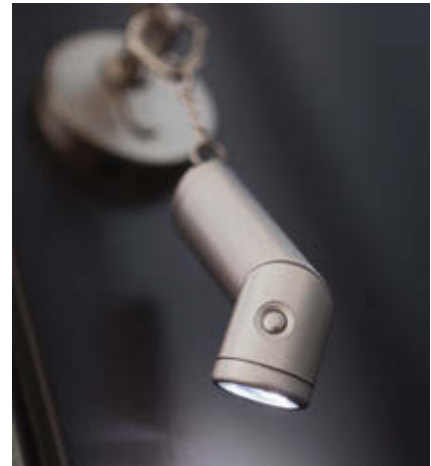

SLIDING

Key chain "Sliding": with white LED light and key ring – white circular inner section can be turned to attach key ring

Packing: 100/500 pieces | Size: 7,4x3,7x1,1 cm

Branding:

-  Ø20 mm K1+H2
-  Ø20 mm DP1+H2
-  Ø20 mm L1+H2

 2x INCL.



56-0407941
blue/white



56-0407940
black/white



56-0407942
red/white



56-0407943
green/white



SUNPOWER 56-0407890

LED key ring "Sunpower" with 3 white LEDs, solar panels to recharge

Packing: 100/500 pieces |
Size: 5,7x3,5x0,8 cm

Branding:

-  15x15 mm K1+H3
-  15x15 mm L4+H3



 Solar

SHOPPING

LED key ring "Shopping" with integrated token for the shopping cart, white light and key ring

Packing: 100/400 pieces | Size: 6,3x2,9x0,5 cm

Branding:

-  15x10/30x15 mm K1+H2
-  15x10/30x15 mm L4+H2

 2x INCL.



56-0407906
silver/orange



56-0407903
silver/blue



56-0407904
silver/black



56-0407905
silver/red

LOOK

Flat key ring "Look" with a triangular shape and white LED light

Packing: 100/500 pieces |
Size: 9,8x2,5x0,9cm

Branding:

30x8/20x15mm K1+H2



56-0407891
blue/silver

56-0407892
red/silver

56-0407895
black/silver

OPEN LIGHT

Key ring "Open light" with a LED light, bottle opener and key ring

Packing: 100/500 pieces | Size: 7x3,4x0,8cm

Branding:

15x15mm K1+H3

20x15mm DP1+H2

15x15mm L4+H3



56-0407897
silver/black

56-0407898
silver/red

56-0407896
silver/blue



MITHRAS

Key ring "Mithras" with white LED light

Packing: 100/500 pieces | Size: 11,5x3,1x1,2cm

Branding:

35x10mm K1+H2

35x10mm DP1+H2

35x10mm L4+H2



56-0407932
white/blue

56-0407933
white/black

56-0407934
white/red

56-0407935
white/orange

56-0407936
white/apple green

56-0407937
white/magenta

HOOK IT 56-0406093

Key ring "Hook it" with red LED light and anti insects sound (engage and disengageable)

Packing: 100/400 pieces | Size: 5,4x3,2x1 cm

Branding:

15x15mm K1+H2



With sound against insects

SOLAR 56-0407844

Key ring "Solar" with a display area to insert your logo (47 x 19 mm), blinks when exposed to direct sunlight, with a key ring

Packing: 50/200 pieces | Size: 6x2,5x1 cm

Branding:

E1+H4



Blinks when exposed to direct sunlight



FLIRT

Key ring "Flirt" includes a condom

Packing: 100/500 pieces | Size: 6x4,3x1,5cm

Branding:

10x20mm K1+H2

45x30mm DP2+H2

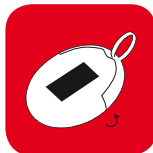

56-0407875 black



56-0407876 blue/orange 56-0407872 grey/white 56-0407873 red/black 56-0407874 blue/white 56-0407885 white

NEAT

Key ring "Neat" with a microfiber cloth for cleaning glasses or camera lenses

Packing: 100/500 pieces | Size: 6x4,3x1,5cm

Branding:

10x20mm K1+H2

45x30mm DP2+H2

110x110mm T2+H4

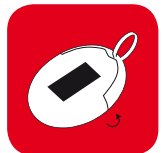

56-0407704 blue/orange



56-0407700 grey/white 56-0407701 red/black 56-0407702 blue/white 56-0407703 black

FELT

Key ring "Felt"

Packing: 100/500 pieces |

Size: 9x3,5x0,7 cm | Material: Polyester

Branding:

☒ 55x25mm T1+H2

**CASTLE** 56-0902354

Felt key ring "Castle" in the form of a crown, with three crystals in the crown spikes and a key ring

Packing: 200/1000 pieces |

Size: 6,7x3,5x0,3 cm | Material: Polyester

Branding:

☒ 12x12mm T1+H2

**FLOATING**

Floating key chain "Floating", suitable for water: cord with key ring, EVA tag floats on the surface

Packing: 200/800 pieces |

Size: 14,4x5,4x1,4 cm

Branding:

☒ 35x10mm L4+H2

 **NEW**56-0407863
blue **Floats on the surface**56-0407865
yellow56-0407864
red

GIRL + BOY

Key ring "Girl + Boy": colour matching band made of soft plastic connects the key ring with decorative pendant

Packing: 50/250 pieces |

Size: 10,5x3,5cm | Material: Zinc Alloy

Branding:

☑ 10x5mm K2+H4+V1

☑ 10x5mm L1+H4



56-0407939
silver/red

56-0407938
silver/blue

STRONG

Wristband "Strong" made of silicone with engraving plate to personalize

Packing: 250/1000 pieces | Size: Ø7x1,3cm |

Material: Silicone/Stainless Steel

Branding:

☑ 15x5mm K1+H2+V1

☑ 15x5mm L1+H2



56-0402371
black

56-0402370
white

56-0402372
grey

56-0402373
blue

56-0402374
red

56-0402375
apple green

56-0402376
pink

FESTIVAL

Wristband light "Festival" with 3 LED lights, 2 light modes (steady light or flashing), milky-white silicone band glows in the dark

Packing: 100/400 pieces | Size: one size |

Material: ABS/Silicone

Branding:

☑ 15x10mm K1+H2

2x
INCL.



👉 Wristband glows in the dark



56-0403127
red/transparent



56-0403128
orange/transparent



56-0403129
green/transparent



56-0403126
blue/transparent



SOFTIE

Key chain "Softie": with silicone band and pullable key ring with twist closure

Packing: 50/250 pieces | Size: 2,5x11,5-19,5 cm

Branding:

☑ 20x10mm K1+H2+V2

☑ 20x10mm L1+H2



56-0407928
red/silver



56-0407925
white/silver



56-0407926
black/silver



56-0407927
blue/silver

 With fastening loop



SLIDE 56-0405250

Lanyard keychain "Slide": with cell phone strap, carabiner and anti-stress pad

Packing: 100/500 pieces | Size: 50x5x2,5 cm

Branding:

☑ Ø20mm K2+H2

☑ 50x5mm T1+H2



TRI KEY

Lanyard with keyrings "Tri Key" with plastic element for advertising, 2 carabiner hooks, loop for mobile phones and safety clip

Packing: 100/500 pieces |

Size: 41 x 1,8 cm

Branding:

☑ 30x10mm K1+H2

56-0405226
red



56-0405228
magenta



56-0405225
blue



56-0405229
lilac

56-0405227
orange

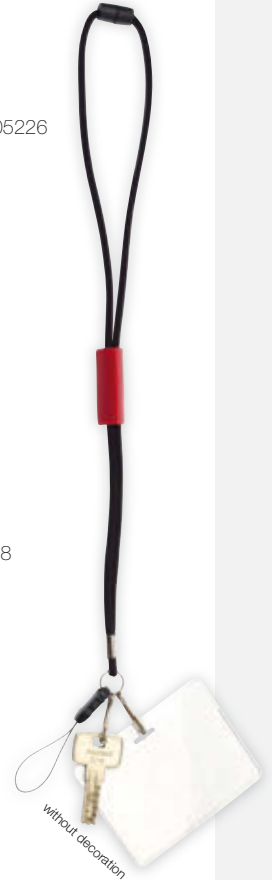

DESIRE 56-0407850

Fold-out handbag holder "Desire": in heart shape, rubber-coated underside ensures secure grip on tables

Packing: 50/250 pieces | Size: 4,6x4,6x0,7 |
Material: Zinc Alloy

Branding:

 20x5/12x12mm K1+H2

 15x10mm L1+H2

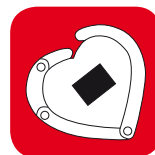
**HEART-IN-HEART** 56-0407813

Key ring "Heart-in-heart"

Packing: 50/200 pieces |
Size: 8x3,9x0,6cm

Branding:

 20x10mm K1+H2+V2

 20x10mm L1+H2

**MONTREUX** 56-0407828

Fold-out handbag holder "Montreux" with a stainless steel surface for advertisement and a rubber base ensures steady hold on tables

Packing: 50/250 pieces | Size: 4x4x0,9cm |
Material: Zinc Alloy

Branding:

 20x20mm K2+H2+V1

 20x20mm DP1+H2

 20x20mm L1+H2





MONEY COLLECTOR

Piggy savings bank "Money Collector" with removable snout to remove the money and coin slit on the back

Packing: 56/112 pieces |
Size: 9,9x8x7,5 cm

Branding:
 25x15/20x10mm K2+H1+V1



56-0908034
 pink



without decoration

56-0908033
 blue



COLLECTOR

Felt coin pouch "Collector", with zipper

Packing: 200/1000 pieces | **Size:** 11,1x7,4 cm |
Material: Polyester

Branding:
 70x40mm T1



56-0405206
 blue

without decoration



56-0405205
 grey



56-0405207
 red



56-0405208
 green



56-0405209
 pink

EDITION

Felt business card holder "Edition": several slide-in pockets and a zip pocket inside, with press stud closure

Packing: 50/200 pieces | **Size:** 16,4x9,7x1,1 cm |
Material: Polyester

Branding:
 50x40mm T1+H2



56-0405214
 grey/pink



56-0405210
 grey



56-0405211
 grey/blue



56-0405212
 grey/red



56-0405213
 grey/green

VACATION 56-0404444

Passport wallet "Vacation": with 9 pockets and one pocket for the passport

Packing: 10/60 pieces |

Size: 14,5x11x1,5 cm | Material: Leather

Branding:

30x15 mm P2+H5

40x20 mm K2+H5

120x90 mm DP2+H2



I'm ready to travel.

**WALL STREET** 56-0404442

Genuine leather credit card wallet "Wall Street" with 12 slip-in pockets and 2 transparent slip-in pockets

Packing: 20/40 pieces |

Size: 11,7x9,3x1,5 cm | Material: Leather

Branding:

50x30 mm P1+H2

50x30 mm L5+H2

**HOME** 56-0404031

Key pouch "Home" with a zip and key ring, 5 different colours assorted

Packing: 100/500 pieces | Size: 11x7x0,5 cm

Branding:

50x30 mm K1



DAX 56-0404445

Genuine leather wallet "Dax" with slip-in pockets on the inside for cards, 1 net pocket for ID, 2 large pockets for notes, 1 pocket for coins with press stud, oval metal plate for logo

Packing: 10/40 pieces | **Size:** 12x9,5x2 cm | **Material:** Genuine leather

Branding:

☰ 20x7 mm K2+H5

✂ 20x7 mm L1+H5

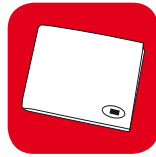
**CASH** 56-0404447

Genuine leather wallet "Cash" with various slip-in pockets for cards, 3 net pockets for ID, driver's licence etc, 1 small zip inner pocket, 2 large slip-in pockets for notes, 1 coin pocket with press stud, oval metal plate for logo

Packing: 10/40 pieces | **Size:** 12,3x9,4x2,5 cm | **Material:** Genuine leather

Branding:

☰ 20x7 mm K2+H5

✂ 20x7 mm L1+H5

**DOW JONES** 56-0404446

Genuine leather wallet "Dow Jones" with slip-in pockets for cards, 1 net pocket for ID, 2 large pockets for notes, 1 pocket for coins with press stud, oval metal plate for logo

Packing: 10/40 pieces | **Size:** 12,5x10x2 cm | **Material:** Genuine leather

Branding:

☰ 20x7 mm K2+H5

✂ 20x7 mm L1+H5



MESSINA 56-0404435

Genuine leather purse "Messina" with various slip-in pockets and a pocket for coins with a press stud closure

Packing: 12/60 pieces | **Size:** 10,5x12x1,5 cm |
Material: Genuine leather

Branding:

- 📏 40x20mm P1+H2
- 📏 80x80mm DP2+H2
- 📏 40x20mm L5+H2



I make my own money.

**PALERMO** 56-0404441

Genuine leather wallet "Palermo" with various slip-in pockets and a pocket for coins with a press stud closure

Packing: 20/40 pieces | **Size:** 11x9x2 cm |
Material: Leather

Branding:

- 📏 50x30mm P1+H2
- 📏 50x40/50x30mm K1+H2
- 📏 60x50mm DP2+H2
- 📏 50x40mm L5+H2

**TRAPANI** 56-0404465

Genuine leather purse "Trapani" with various slip-in pockets and a pocket for coins with a press stud closure

Packing: 12/60 pieces |
Size: 11,8x9,2x1,5 cm |
Material: Genuine leather

Branding:

- 📏 40x20mm P1+H2
- 📏 80x60mm DP2+H2
- 📏 40x20mm L5+H2



SERVICE & QUALITY

OFFICE & BUSINESS

MUSIC & TIME

LIGHTS & TOOLS

SAVE & PRACTICAL



HOME & LIVING

➤ *„We love convivial gatherings with our friends.“*

Our home is chill out zone and nightlife district at the same time. We unwind on the sofa and party with friends in the kitchen. What we need to be happy? A healthy cup of tea, a glass of nice wine, some candlelight, and a relaxing massage... That is our all-round carefree package!



BLACK + WHITE 56-0340016

Coffee set "Black + White" consists of 2 mugs with spoon holders in the handles and 2 spoons with holes in the handles to hang them up, capacity of each cup approx. 300 ml, in a safety packing

Packing: 10 sets | Size: Ø8,4x10,5cm | Material: Ceramic

Branding:

☺ 30x30mm K2+H4

☺ 20x40mm T4+H4



SENSATION 56-0340027

Cup set "Sensation": consists of 2 cups and 2 oval shaped coasters for placing biscuits, each cup approx. 185 ml, packed in a gift box

Packing: 10 sets | Size: 20x14cm | Material: Porcelain

Branding:

☺ 40x10mm K2+H4

☺ 40x10mm T4+H4

☺ 40x10mm L5+H4



HOT MESSAGE 56-0340018

Ceramic mug "Hot message" with 2 pieces of chalk to draw on the surface of the mug, 300 ml, packed in a safety gift box

Packing: 10/30 pieces | Size: Ø8x9,8cm | Material: Ceramic

Branding:

☺ 35x10mm K2+H3+V2

☺ 35x10mm T4+H3

☺ 140x20mm S7+H3



 Writeable surface

4 SEASONS 56-0340042

Mug set "4 Seasons": 4 differently coloured mugs with handles, coloured outside and white inside, capacity approx. 355 ml – dishwasher and microwave safe – delivered in gift box

Packing: 4/8 sets | Size: Ø9x9cm |
Material: Ceramic

Branding:

☰ 30x30mm K2+H4+V1

**LA DOLCE VITA** 56-0340017

Espresso set "La dolce vita" consists of 6 cups with coasters, packed in a gift box

Packing: 12 sets | Size: 24x20,5x6 cm |
Material: Porcelain

Branding:

☰ 40x40mm K2

☰ 10x35/Ø30mm T4+H7

**HIGH FIVE**

Mug set "High five" with white coaster - which can also be used as a lid or tea bag holder - spoon in the handle, colours on the inside, spoon with hole to hang up, capacity approx. 300 ml, packed in a gift box

Packing: 24 pieces | Size: Ø8,5x11,5cm |
Material: Ceramic

Branding:

☰ 20x30mm K2+H4

☰ 20x40mm T4+H4



56-0340035:

without decoration

56-0340036
white/blue



56-0340035
white/red



56-0340037
white/green



56-0340038
white/orange



56-0340039
white/yellow

SWEET TEA 56-0304384

Stainless steel tea strainer "Sweet Tea": ideal dosage for a cup or a small tea pot – convenient one-hand control, spherical strainer with spring opens through sliding mechanism and keeps the tea securely enclosed, dishwasher safe, in gift box

Packing: 50/100 pieces | Size: Ø5 x 18 cm | Material: Stainless Steel

Branding:

☞ 50x3 mm K1+H2+V1

☞ 60x5 mm L1+H2



without decoration



GREAT PLEASURE 56-0304385

Tea rod "Great Pleasure" with a strainer and a press mechanism for easy filling and emptying, packed in a gift box

Packing: 50/300 pieces | Size: Ø2 x 15,7 cm | Material: Stainless Steel

Branding:

☞ 30x10 mm DP1+H2

☞ 30x10 mm L1+H3

☞ 55x50 mm LR2+H3 360°



without decoration

INDIVIDUAL 56-0340019

Tea cup set "Individual": consists of 4 cups with shaped handles, capacity of each cup approx. 100 ml, 4 wooden coasters, on wooden tray, packed in gift box

Packing: 15 sets | Size: 8,2x8,2 cm | Material: Porcelain/Wood

Branding:

☞ 20x20 mm K2+H5

☞ 35x13 mm T4+H5



HOT HEART 56-0340040

Heart-shaped ceramic mug "Hot Heart" consists of spoon with hanging loop, handle with spoon holder, packed in a gift box

Packing: 24 pieces | Size: 10,6 cm

Branding:

 35x10mm K2+H4+V2

 40x30mm T4+H4

**SWEET HEART** 56-0340008

Heart-shaped fondue set "Sweet Heart" consists of a bowl, base and 4 fondue forks with heart-shaped handles

Packing: 20 pieces | Size: 13x11x11,4 cm |

Material: Ceramic

Branding:

 30x30/40x25 mm K2+H7

 30x30/50x30 mm T4+H7

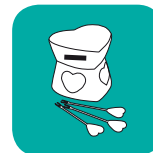
**HOT CHOCOLATE** 56-0340041

Chocolate fondue "Hot Chocolate" in mug shape: incl. 2 stainless steel forks with plastic handles, space for inserting tea light, in a giftbox

Packing: 24 pieces | Size: Ø 10,5 x 14,5 cm | Material: Ceramic

Branding:

 25x25mm K2+H5

 25x25mm T4+H5



MAGNETIC 56-0401056

LCD timer "Magnetic" with digital display, magnet and a clip which can be used as a stand

Packing: 100/200 pieces | Size: 7x5x1,5cm

Branding:

-  30x15mm K1+H3
-  30x10mm DP1+H2
-  30x15mm L4+H3

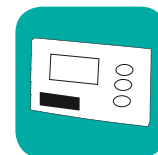

 Magnetic

GET 2 GETHER 56-0340012

Salt and pepper set "Get 2 gether" consists of a black salt and white pepper shaker

Packing: 25/75 sets |

Size: 7,5x5,5x3,5cm | Material: Ceramic

Branding:



-  10x20/25x10mm K2+H3+V1
-  10x20/25x10mm T4+H3

**MEAL** 56-0304400

Place mat set "Meal" made from washable PVC/polyester, consists of 4 mats with pattern 45x30cm, packed in a transparent packing

Packing: 20 sets | Size: 45x30cm

Branding:

-  25x15mm K1
-  40x20mm E1

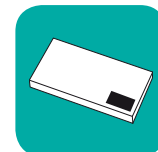

HEART PAN 56-0306009

Frying pan "Heart Pan": heart-shaped frying area, approx. 9,5 cm long, 8 cm wide, 1,5 cm high, with non-stick coating, plastic handle with hanger – ideal for preparing scrambled eggs and pancakes

Packing: 50 pieces | **Size:** Ø 12x2x26 cm

Branding:

📦 10x10mm L1+H4



without decoration



Spice up your life

**FUNNY EGGS** 56-0340031

Salt and pepper set "Funny eggs": 2 porcelain shakers shaped as an egg on a white porcelain stand, in a gift box

Packing: 50 sets | **Size:** 10,5x3,8x5,2 cm |
Material: Ceramic

Branding:

📦 20x10/15x15 mm T4+H5

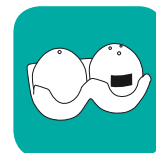

SPICE FLAVOUR 56-0304346

Salt and pepper shaker set "Spice Flavour" made of stainless steel, with transparent window, twist mechanism and ceramic grinder, in transparent gift box

Packing: 24/96 sets |
Size: Ø3x5,2/6,6x3,3x5,5 cm |
Material: Stainless Steel

Branding:

- ☰ 15x15mm K2+H2+V1
- ☑ 10x10mm L1+H2
- ☑ 95x10mm LR1+H2 360°



INNOVATION 56-0304373

Salt and pepper mill "Innovation": with rubber-coated surface, transparent looking area and turning mechanism, on the one side pepper comes out and on the other side salt, packed in a gift box

Packing: 50 pieces | Size: Ø8,1x10,5 cm

Branding:

- ☰ 20x10mm K1+H4+V1
- ☑ 20x10mm L4+H4



LIFESTYLE 56-0304375

Oil and vinegar shakers "Lifestyle" for precise and hygienic dosage, glass bottle with screwable metal/plastic lid - easy to use with one hand due to the pump mechanism

Packing: 10 sets | Size: Ø4x16,4 cm |
Material: Stainless Steel

Branding:

- ☰ 12x20mm K2+H4+V1
- ☑ 115x25mm LR3+H4 360°
- ☑ 12x20mm L2+H4

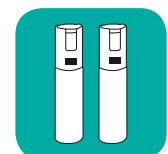

HOT LIGHT 56-0304362

Rubber-coated electric salt and pepper mill "Hot Light" with light, packed in a gift box

Packing: 8/40 pieces | Size: Ø5x22 cm

Branding:

☞ 20x20mm K1+H2+V1

☞ 20x20mm L4+H2



AA/LR6/AM3

 With a light



without decoration

**FANTASTIC** 56-0304387

Stainless steel spice rack "Fantastic": contains 6 colourful stainless steel spice tins with magnetic bottom and lid with transparent viewing window and dispenser with two different openings for perfect dosage, stainless steel rack with stand, in a gift box

Packing: 10 sets | Size: Ø6,3x4,3/15,7x23 cm |

Material: Stainless Steel

Branding:

☞ 20x20mm L2+H6

☞ 7x11 mm L1+H6



 Magnetic

FAMOUS 56-0304393

Salt and pepper mill "Famous" with transparent edges and turning mechanism to grind the salt and pepper, removable top for easy refill, rubber-coated body, packed in a gift box

Packing: 48 pieces | Size: 6,5x5x8,6 cm

Branding:

☞ 30x10mm K2+H2+V1

☞ 30x10mm L4+H2



without decoration



without decoration



ROASTBEEF 56-0304370

Stainless steel cutlery set "Roastbeef", consists of a knife and a fork packed in a silver case with a transparent lid

Packing: 30 sets | **Size:** 34x8x3,5 cm |
Material: Stainless Steel

Branding:

-  50x10mm K1+H2
-  60x4mm K1+H3+V1
-  35x8mm L1+H3



ENSEMBLE 56-0301116

Knife set "Ensemble" packed in wooden case, consists of a waiters knife, knife sharpener and 3 knives

Packing: 10 sets | **Size:** 34,5x16x3,7 cm |
Material: Stainless Steel

Branding:

-  60x10mm K2+H2+V1
-  340x150mm DP2+H2
-  35x10mm L1+H4
-  50x10mm L5+H2



CARVE 56-0301126

3-piece stainless steel carving set "Carve": consists of sharpening rod with a metal loop to hang, carving knife, and meat fork, packed in a simple box

Packing: 12 sets | **Size:** 30,5 cm |
Material: Stainless Steel

Branding:

-  20x7 mm K1+H2
-  55x8/20x3mm L1+H2



ITALY 56-0301118

Pizza cutting board "Italy" with 4 forks, 4 knives and a pizza cutter, packed in a gift box

Packing: 10 sets | Size: Ø32 cm

Branding:

✂ 50x30mm K2+H7

✂ 50x30mm L4+H7

**USEFUL**

Pizza cutter "Useful": with stainless steel cutting wheel, robust plastic handle with exposed advertising area, packed in a gift box

Packing: 25/100 pieces |

Size: 11,2x10,5x1,8cm | Material: Stainless Steel

Branding:

✂ 23x23mm K1+H4+V2

✂ 20x20mm DP1+H2

✂ 25x15mm L1+H4



56-0307010
black



56-0307012
green



56-0307011
red

KEEP UP 56-0301123

Set of steak knives "Keep up" in block: 6 knives with coloured stainless steel blades with serrated edges, rubber-coated knife block with thin plastic rods inside that hold knives, packed in a gift box

Packing: 10/20 sets | Size: Ø8,8x24/21 cm

Branding:

✂ 30x10mm L1+H6

✂ 30x10mm L4+H6



Dinner is served!



ADRIA 56-0340005

Porcelain olive snack dish "Adria", in the form of a wave

Packing: 20 pieces | Size: 18,1x14x2,5 cm | Material: Porcelain

Branding:

 70x12mm T4+H2

**CHIPS + DIPS** 56-0340025

3 piece porcelain chips set "Chips + Dips" consists of 1 large dish and 2 small dishes, packed in a safety gift box

Packing: 15 sets | Size: 20x10,5x4/8,6x4,6x1,5 cm | Material: Porcelain

Branding:

 40x10mm T4+H4

 40x10mm L5+H4

**3 OPTIONS** 56-0340026

4 piece serving set "3 Options" consists of 3 square porcelain dishes on a wooden tray with metal handles, packed in a safety gift box

Packing: 15 pieces | Size: 27,5x11 cm | Material: Porcelain/Wood

Branding:

 60x8mm K1+H4

 40x10mm T4+H4

 40x10mm L5+H4





FAMILY 56-0310016

Raclette grill "Family" with coated grill and 6 small pans with insulated handles, suitable for 6 people, packed in a gift box

Packing: 6 pieces | Size: Ø37x13,5 cm | Material: Metal

Branding:

E1



MALTA 56-0340014

Dip set "Malta" consists of 4 tear drop shaped porcelain bowls on a wooden tray, packed in a safety gift box

Packing: 5/15 pieces | Size: 18,5x18,5x1,5 cm | Material: Porcelain/Wood

Branding:

30x10/5x25mm K1+H5

40x10mm T4+H5

40x10mm L5+H4

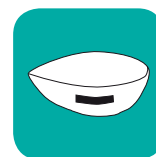

CLICK 56-0301098

Bamboo-Nutcracker set "Click" with bowl and groovings for the nutcracker

Packing: 24 sets | Size: 15,5x15,5x8,4 cm

Branding:

40x40mm K2+H5+V1

35x5mm L2+H4

50x10mm L1+H4

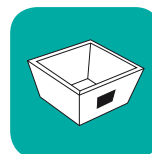

CHEESE 56-0304358

Cheese cutlery set "Cheese" consists of soft cheese knife, hard cheese knife, cheese plane and blade with a waved pattern, all handles have a practical loop to hang up



Packing: 10/20 sets | Size: 30x18,6x2,4 cm |
Material: Stainless Steel

Branding:

- 40x5 mm K2+H2
- 40x5 mm L2+H4

**CHEDDAR** 56-0301129

Cheese grader "Cheddar": ideal to cut thin cheese slices – with comfortable moulded grip and practical hanging loop to attach to kitchen board



Packing: 50/200 pieces | Size: 17,5x7 cm

Branding:

- 35x35 mm K1+H2
- 30x30 mm L4+H2

**ORBIT** 56-0301125

Cheese cutlery set "Orbit": consists of a wooden board with integrated glass plate, under the cutting area are 3 knives and a fork which are fixed with a magnet, packed in a gift box

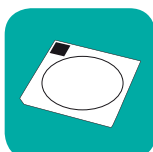

Packing: 10 pieces | Size: 23x23x2,4 cm

Branding:

- 35x15 mm K2+H5
- 190x190 mm DP2+H2
- 50x20 mm DP1+H2
- 35x15 mm L5+H5
- 50x20 mm L5+H4

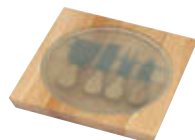



TRICOLOUR 56-0307035

Cutting board "Tricolour": 3 differently coloured cutting boards with practical handle – suitable for hygienic preparation of different foods, such as fish, meat, and vegetables – including plastic stand for tidy storage in the kitchen

Packing: 5 sets | Size: 23,5x8x33 cm

Branding:

☰ 70x25 mm K1+H4+V1

☰ 220x180 mm DP2+H4

☑ 80x20 mm L2+H4

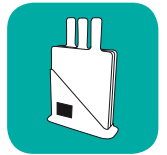

SUNNY

Cutting board "Sunny": consists of knife with stainless steel blade with integrated bottle opener and suspension hook in handle, extra protection case, board with integrated hanging

Packing: 50 pieces |

Size: 29,5x19,5/21,4x2,9x1,3 cm

Branding:

☰ 30x10 mm K1+H2+V1

☰ 30x10 mm DP1+H2

☑ 30x10 mm L4+H2

56-0307016
green

56-0307017
blue



56-0307018
pink



COMFORT LINE 56-0301124

Ceramic peeling set "Comfort line" consists of a peeler and knife with ceramic blades, handles are made out of strong plastic

Packing: 100 sets |

Size: 17,5x2,2x1,5/15x5,8x1,5 cm |

Material: Ceramic blade

Branding:

☰ 25x10 mm K1+H4+V1

☐ E1



i Advantages of ceramic blades: rustproof, dishwasher proof, odorless and tasteless. Ceramic blades stay longer sharp in contrast to usual cutting areas.

DIVIDE 56-0307009

Pair of scissors for the household "Divide" with a stainless steel blade packed in a protective cover

Packing: 50/150 pieces |

Size: 20x8,7x1,2cm

Branding:

☰ 40x20mm T1+H4

☑ 40x5/Ø10mm L1+H4

**RACY** 56-0307002

Pair of scissors for herbs "Racy" with 3 blades, green plastic handles and cleaning brush, packed in a cover with Velcro

Packing: 36/144 pieces |

Size: 6,4x14/7,5x15,5cm |

Material: Stainless Steel

Branding:

☰ 20x20mm T1+H5

☑ 20x4mm L1+H5

**CUT**

Serving knife "Cut": ideal for pies and tarts – with serving area for a piece and blade with serrated edge

Packing: 100 pieces |

Size: 28,5x6x0,8cm

Branding:

☰ 45x10mm K1+H2+V2

☑ 45x10mm DP1+H2

☑ 45x10mm L4+H2



56-0307015
green



56-0307013
white



56-0307014
blue





SPLIT

Apple cutter "Split": with plastic handle in the shape of an apple and stainless steel cutters

Packing: 12/48 pieces |
Size: 15,5x14x2 cm

Branding:

☑ 30x10mm K1+H2
☑ 30x10mm DP1+H2

56-0307020
red



56-0307019
green



MOOSE PETER

Peeler "Moose Peter": stainless steel blade, in transparent gift box

Packing: 24 pieces |
Size: 16,5x7,5x4 cm

Branding:

☑ 7x5 mm K1+H2



56-0307026
blue



56-0307025
red



56-0307027
green



FRUIT 56-0304359

Fruit cutlery set "Fruit" consists of an orange knife, lemon grater, pulp spoon and apple corer, all have a practical loop to hang up

Packing: 20/40 sets | Size: 13,2x23x2,4 cm |
Material: Stainless Steel

Branding:

☑ 40x5 mm K2+H4
☑ 40x5 mm L1+H4





CROCO 56-0306014

Silicone glove "Croco" ideal for touching hot pots and pans with loop to hang up

Packing: 50/100 pieces |

Size: 7x10,5x9cm | Material: Silicone

Branding:

☐ 25x25 mm E1+H4

Phthalate free

 Made of silicone



PRECISE 56-0499070

Digital spoon scale "Precise" ideal for weighing tea, fluids or spices - for small dosages from 0,1g/0,005 oz to a maximum of 300g/10,935 oz, with a hold and tara function, ON button, turns itself off automatically, with a hanger assembly

Packing: 10/50 pieces | Size: 22x5x2,9cm

Branding:

☐ 15x7 mm K1+H4

☐ 15x7 mm L4+H4



 Up to 300g

EXQUISITE 56-0499064

Kitchen scale "Exquisite" with metal plate, weight display in grams and pounds, time display, light up LCD screen and 2 buttons, weighs up to 3 kg, packed in a gift box

Packing: 10/30 pieces | Size: 21x16x3,2cm

Branding:

☐ 40x12 mm K2+H4

☐ 40x12 mm L4+H4



 Weighs up to 3 kg

AAA/LR03/AM4



FASCINATION 56-0304120

Kitchen helper "Fascination" consists of a dough scraper, baking and roasting tool for greasing kitchen utensils, transparent frosted handles with hanging holes

Packing: 60 sets | **Size:** 20,5x4/25x5,5 cm | **Material:** Silicone

Branding:

☞ 50x30mm K1+H6



i In contrast to other materials silicone is heat-resistant and dishwasher proof. Metal may rust, wood may break when it gets constantly in touch with water.

**COOKIE HEART** 56-0304392

Cup cookie cutter "Cookie Heart", heart-shaped: ideal to cut cookies that can be attached to the rim of a cup

Packing: 100/400 pieces | **Size:** 5,3x5,5x2 cm | **Material:** Stainless Steel

Branding:

☞ 30x10mm L1+H2

**CUPCAKE** 56-0304404

Baking cups "Cupcake": 4 differently coloured flexible baking cups made of silicone, heat-resistant and food safe, with non-stick coating for easy baking without greasing – ideal for muffins and cupcakes

Packing: 50/200 sets | **Size:** Ø4,5-7x3,5 cm | **Material:** Silicone

Branding:

☞ Ø30mm K1+H2



☝ Made of silicone



FLOWER

Salad cutlery "Flower", 2 piece, shaped like flowers

Packing: 60 sets | Size: 32x8,5cm

Branding:

☑ 20x10mm K1+H2+V1



56-0307021
pink

56-0307022
blue

56-0307023
orange

56-0307024
green



KEEP FRESH 56-0307028

Clip set "Keep Fresh": consists of 3 large and 3 small clips – to seal plastic bags and freezer bags

Packing: 125/375 sets | Size: 7,5x1,5/5,5x1,5cm

Branding:

☐ 40x20mm E1

☐ 70x50mm E3



without decoration

SECURE

Oven glove set "Secure", 2 pieces: consists of oven glove and oven mitt with loops for hanging

Packing: 100 sets |

Size: 27x16x1,5/18x18x0,5cm

Branding:

☑ 120x120mm T2+H3

☑ 80x80mm T1+H3



56-0306019
red



56-0306020
blue



QUIRLY

Whisk "Quirly" made from silicone and stainless steel with a loop in the handle to hang up

Packing: 24/144 pieces | Size: 26 cm |
Material: Stainless Steel/Silicone

Branding:

☞ 30x10mm K1+H2+V2

☞ 30x10mm L1+H2



56-0304394
silver/light green

56-0304395
silver/yellow

56-0304396
silver/pink

56-0304397
silver/light blue

JOKO

Thermobox "Joko": removable insert (suitable for microwave) with 2 compartments on the inside, screwable cover with integrated handle and slot to store foldable spork, keeps food hot or cold up to 4 hours, capacity approx. 450 ml

Packing: 36 pieces | Size: Ø 13x11 cm

Branding:

☞ 45x25 mm K2+H4+V1



56-0306018
blue

☞ Holds heat / cold
up to 4 hours



56-0306017
green





I live healthy.



VEGGIE CUP

Salad cup "Veggie Cup": cup with capacity of approx. 850 ml, removable container for dressing (approx. 70 ml) integrated in lid, lid can be easily opened thanks to protruding grip, includes plastic fork (can be attached to lid), dishwasher and microwave safe

Packing: 36 pieces | Size: Ø 11 x 19 cm

Branding:

☑ 30x20mm K2+H2+V1



56-0307030
white



56-0307031
blue



56-0307032
apple green



without decoration



EAT FRESH

Salad bowl "Eat Fresh": with plastic fork integrated into lid and a container for the dressing, lid can be easily opened and closed thanks to protruding grip, dishwasher, freezer, and microwave safe, capacity: approx. 1,25 l

Packing: 36 pieces | Size: 22,5x18,5x9,5 cm

Branding:

☑ 30x15 mm K2+H2+V1

☑ 30x15 mm L1+H2



56-0307036
light blue



56-0307037
apple green

without decoration

👉 Approx. 1,25 litre



CEREALS

Cereal cup "Cereals": screw cap with additional compartment to be filled with cereal, transparent cup (capacity approx. 350 ml) – ideal for yoghurt – has a rubber-coated sleeve with mount for a plastic spoon (incl.)

Packing: 30/60 pieces | **Size:** Ø6-8,5x16,5 cm

Branding:

☑ 30x15mm K1+H2+V1



👉 **Approx.**
350 ml



56-0307042
white



56-0307044
apple green



56-0307043
blue



TASTY

Lunchbox "Tasty": with two separate compartments to fill, plastic knife and fork integrated in additional dent in lid, dishwasher safe

Packing: 36 pieces | **Size:** 22,5x14,5x6,5 cm

Branding:

☑ 70x20mm K2+H2+V1

☑ 130x90mm DP2+H2

☑ 100x100mm L5+H2



56-0306021
blue



56-0306022
red



FRESH AND COLD

Bowl set "Fresh and Cold" with freezer pack: consists of 1 big bowl (approx. 900 ml capacity) with removable cooling ring and lid with integrated pull-out spoon, inside 1 small bowl (approx. 370 ml) with lid – food is cooled for up to two hours – ideal for salad and dressing or pudding with fruit

Packing: 10 sets | **Size:** Ø17x11,5 cm

Branding:

☑ 30x77/35x35mm K2+H4



👉 **With cooling ring**

GRIP 56-0604063

Stainless steel barbecue tongs "Grip": with plastic hand grip, rubberized hanger at the end, and locking mechanism for space-saving stowage – suitable for cooking, frying, grilling and serving

Packing: 12/48 pieces | **Size:** 1,8/4,3x36cm

Branding:

🔪 10x25mm L1+H2

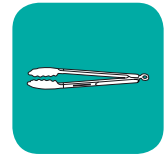
**ALLROUNDER** 56-0304376

Mechanical metal beater "Allrounder", quick rotation with up-and-down movement without using a lot of strength

Packing: 36 pieces | **Size:** Ø6x35cm | **Material:** Stainless Steel

Branding:

🔪 12x12mm K2+H4+V1

🔪 12x12/40x8mm L2+H4

🔪 75x50mm LR2+H4 360°



👉 Works without electricity

**AL DENTE** 56-0304331

Spaghetti set "Al Dente" with a cheese grater, spaghetti portioner, spaghetti tong and a ladle

Packing: 10/20 sets | **Size:** 30,5x20,5x5 cm | **Material:** Stainless Steel

Branding:

🔪 40x5mm L2+H4



without decoration

GOURMET 56-0499068

Cooking thermometer "Gourmet" with an aluminium front, alarm for the desired temperature, timer (also usable as an egg timer), 3 control buttons and LCD screen (for °C and °F)

Packing: 40/80 pieces | **Size:** 7x6,4x1,8 cm |
Material: Aluminium

Branding:

☑ 40x10mm K1+H3+V1

☑ 40x10mm L1+H3

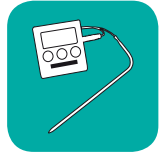

AAA/LR03/AM4

**MAITRE** 56-0499069

BBQ fork "Maitre" with thermometer, consists of a plastic handle, 2 red control buttons, LCD screen (for °C and °F) and hanger, with blue background light

Packing: 20/40 pieces | **Size:** 38,5x2,8x2,5 cm

Branding:

☑ 15x15/10x15mm K2+H4

☑ 15x15/10x15mm L3+H4



AAA/LR03/AM4

**HOT SPOT** 56-0499062

Cooking thermometer "Hot spot": stainless steel dipstick, LCD display, on-off switch, switchable from °C to °F, cap with red clip and eyelet for hanging

Packing: 50/200 pieces | **Size:** Ø 1,9x20,5 cm |
Material: ABS

Branding:

☑ 14x4mm L4+H2

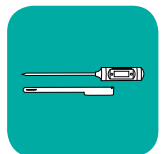

EXQUISITE WINES FOR WINE LOVERS

There are many opportunities in life that one should celebrate by raising a toast with a glass of fine wine. Our Argentine red and white wines ensure a perfect indulgence for every occasion.



2012 FAMIGLIA BIANCHI – CABERNET SAUVIGNON 56-1200012

This wine displays a deep ruby colour and very good legs. Spicy and complex aromas of black pepper, liquorice, coffee grains and hints of fresh mint mingle with blackcurrant and wild berries. The Cabernet presents itself with an ample and persistent mouthfeel, and a harmonious structure that highlights its personality and royal lineage. Goes well with lamb, game and hard cheese.

Variety: 100% Cabernet Sauvignon

Taste: dry

Residual sugar: 3,76 g/l

Acidity: 5,51 g/l

Alcohol content: 14 % vol.

Serving temperature: 16-18 °C

Packing: 6 pieces | Size: 750 ml



2013 FAMIGLIA BIANCHI – MALBEC 56-1200013

This Malbec expresses all the typical characteristics of this grape with its dark red-violet colour, its fruity aroma of ripe plums and cherries, combined with the spicy notes of French oak and the sweet chocolate of American oak. This brings out its freshness, balance and elegance, with a delicate structure and a long and velvety mouthfeel. Enjoy with pasta or grilled meat.

Variety: 100% Malbec

Taste: dry

Residual sugar: 3,25 g/l

Acidity: 4,8 g/l

Alcohol content: 14,5 % vol.

Serving temperature: 15-18 °C

Packing: 6 pieces | Size: 750 ml



 Famiglia Bianchi: awarded at the wine competition in Paris for the world's best red wine

2014 ELSA BIANCHI — MALBEC

56-120007

This wine impresses by its intensive dark purple colour. Its opulent aroma with the plum note characteristic for a Malbec is backed by a hint of vanilla. On the palate, the wine is typical juicy, supported by the full-bodied, silky texture. Enjoy this wine with rich game dishes.

Variety: 100% Malbec

Taste: dry

Residual sugar: 4,02 g/l

Acidity: 5,25 g/l

Alcohol content: 13,5 % vol.

Serving temperature: 16-18 °C

Packing: 6 pieces | Size: 750 ml



2013 ELSA BIANCHI — SYRAH

56-120010

Subtle aromas of sour cherry and cherry stand out in a background of smoked spices. The mouthfeel is complex, tasting of French and American oak. The same cherry flavours first discovered by smell are also found on the palate, and linger through the long, pleasing finish. Perfect with grilled meat and beef.

Variety: 100% Syrah

Taste: dry

Residual sugar: 3,47 g/l

Acidity: 4,87 g/l

Alcohol content: 13,5 % vol.

Serving temperature: 16-18 °C

Packing: 6 pieces | Size: 750 ml



2014 ELSA BIANCHI — CABERNET SAUVIGNON

56-120011

The Cabernet comes with a fruity flavour and aroma of black currants and pepper. The slightly spicy berry bouquet reveals itself in the nose with a hint of cedar. In the glass, the wine impresses by its intensive purple colour. This red wine presents a succulent and rich flavour and is perfectly balanced. Our serving suggestion: perfect with roasted meat and cheese.

Variety: 100% Cabernet Sauvignon

Taste: dry

Residual sugar: 3,6 g/l

Acidity: 4,72 g/l

Alcohol content: 13,5 % vol.

Serving temperature: 16-19 °C

Packing: 6 pieces | Size: 750 ml



ARGENTINE WINE FOR YOUR ADVERTISING

The vineyard Bodega Valentin Bianchi is located in the province of Mendoza, the largest and most important wine-growing region of Argentina. The name Bodega Valentin Bianchi stands for Argentine heart and soul, tradition, and winemaking of outstanding quality. The wines are recognized worldwide and have won numerous awards.

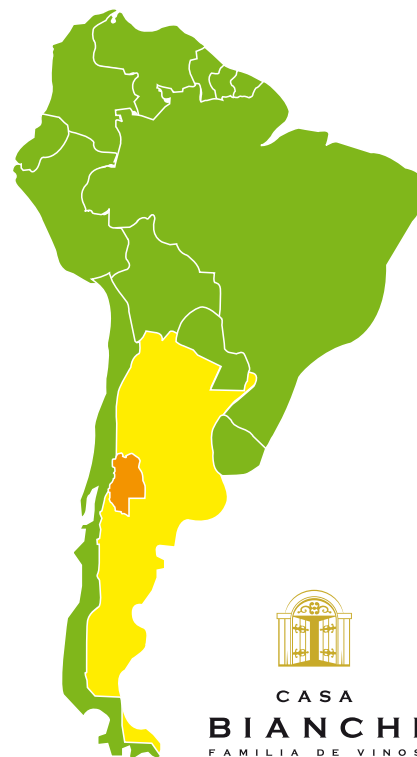

CASA
BIANCHI
FAMILIA DE VINOS

2014 ELSA BIANCHI – CHARDONNAY

56-1200008

This Chardonnay has a bright, medium intensity colour with light greenish shades. The aroma is intense, young and impetuous, with hints of honeyed-lemon, white flowers, pineapple and pear. On the palate, the wine is fresh and silky, enhanced by tropical notes and a balanced acidity. Perfect with Mediterranean cuisine.

Variety: 100% Chardonnay

Taste: dry

Residual sugar: 5 g/l

Acidity: 5,62 g/l

Alcohol content: 12,5 % vol.

Serving temperature: 10 °C

Packing: 6 pieces | Size: 750 ml



2014 ELSA BIANCHI – TORRONTÉS

56-1200009

The bright, clear white wine with intense fruit flavours is reminiscent of citrus fruits such as grapefruit and orange. Furthermore, a touch of green apple and a hint of spice is added. The Torrontés presents itself deliciously fresh with a sense of acidity on the palate. This tangy white wine goes well with fish, vegetables and poultry.

Variety: 100% Torrontés

Taste: dry

Residual sugar: 4,8 g/l

Acidity: 6,11 g/l

Alcohol content: 13 % vol.

Serving temperature: 7-11 °C

Packing: 6 pieces | Size: 750 ml



 For all wines: Personalized bottle label available on request.

2013 +2014 ELSA BIANCHI – MALBEC, SYRAH + CABERNET SAUVIGNON

56-1200090

You love red wine but do not want to commit to one grape variety? Try three of our Argentinean choice wines. This set of three contains one bottle of Malbec, Syrah, and Cabernet Sauvignon each. It is delivered in a high-quality gift box.

Packing: 1 set (3 diff. wines) | Size: 36,5x27 x 10cm/3x 750 ml



2013 +2014 ELSA BIANCHI – SYRAH, CABERNET SAUVIGNON + CHARDONNAY

56-1200091

You enjoy red wine just as much as white wine? With this set of three, there is no either or. It contains one bottle each of Syrah, Cabernet Sauvignon, and Chardonnay. They are delivered in a high-quality gift box.

Packing: 1 set (3 diff. wines) | Size: 36,5x27 x 10cm/3x 750 ml



2014 ELSA BIANCHI – CABERNET SAUVIGNON, MALBEC + TORRONTÉS

56-1200092

We present you with choice wines from Argentina. You will find two bottles of red wine (Cabernet Sauvignon and Malbec) as well as one bottle of our tangy white wine (Torrontés) in a high-quality gift box.

Packing: 1 set (3 diff. wines) | Size: 36,5x27 x 10cm/3x 750 ml



2012 FAMIGLIA BIANCHI – CABERNET SAUVIGNON 56-1200080

This wine displays a deep ruby colour and very good legs. Spicy and complex aromas of black pepper, liquorice, coffee grains and hints of fresh mint mingle with blackcurrant and wild berries. The Cabernet presents itself with an ample and persistent mouthfeel, and a harmonious structure that highlights its personality and royal lineage. Goes well with lamb, game, and hard cheese. Delivered in a high-quality gift box with linen optics.

Variety: 100% Cabernet Sauvignon

Taste: dry

Residual sugar: 3,76 g/l

Acidity: 5,51 g/l

Alcohol content: 14 % vol.

Serving temperature: 16-18 °C

Packing: 1 piece | Size: 37x10,5x9,8cm/750 ml



2013 FAMIGLIA BIANCHI – MALBEC 56-1200081

This Malbec expresses all the typical characteristics of this grape with its dark red-violet colour, its fruity aroma of ripe plums and cherries, combined with the spicy notes of French oak and the sweet chocolate of American oak. This brings out its freshness, balance and elegance, with a delicate structure and a long and velvety mouthfeel. Enjoy with pasta or grilled meat. Delivered in a high-quality gift box with linen optics.

Variety: 100% Malbec

Taste: dry

Residual sugar: 3,25 g/l

Acidity: 4,8 g/l

Alcohol content: 14,5 % vol.

Serving temperature: 15-18 °C

Packing: 1 piece |
Size: 37x10,5x9,8cm/750 ml



VARIED 56-0301427

Wine set "Varied", 3 pieces: consists of waiter's knife with bottle opener, corkscrew and seal cutter, 1 vacuum bottle stopper for long-lasting flavour, and 1 transparent nozzle

Packing: 40/80 sets | Size: 15,7x15,7x3,5 cm

Branding:

✂ 20x5 mm L1+H5

**VACUUM** 56-0301412

Wine bottle stopper "Vacuum" with press button that closes a bottle airtight – for long-lasting wine aroma

Packing: 100/200 pieces | Size: Ø4,5x7,2 cm

Branding:

🍷 Ø 15 mm D1+H2

🍷 Ø 15/10x13 mm K1+H2



👍 With vacuum closure

**BOLERO** 56-0499066

Digital wine bottle thermometer "Bolero" with a plastic holder, auto power on/off when attached/detached to or from bottle

Packing: 20/80 pieces | Size: 7,3x7,2x4 cm

Branding:

🍷 25x3 mm K1+H5+V1

✂ 25x3 mm L1+H5

1x
INCL.

👍 Determines the perfect temperature



i The perfect serving temperature for most of the red wines lies between 18–20 °C. For white wines a serving temperature of 13–16 °C is recommended. In case of extreme cooling the taste and smell aroma are repressed.



LOIRE 56-0301417

Wine set "Loire" consists of a wooden waiter's knife, wine ring, bottle stopper and a metal nozzle, packed in a round box

Packing: 10/40 sets | Size: Ø15x2,4 cm | Material: Stainless Steel

Branding:

☞ 45x45mm K1+H2

☞ 20x5/10x5mm L1+H2

**ELEGANT** 56-0301063

Wine bottle opener "Elegant" with wooden handle and corkscrew

Packing: 25/100 pieces | Size: 11,5x1,5x2 cm | Material: Wood/Stainless Steel

Branding:

☞ 15x5 mm K1+H2

☞ 30x8 mm L4+H2

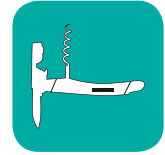
**BURGUNDY** 56-0301405

Wine set "Burgundy" for 2 bottles consists of a wine thermometer, waiter's knife, metal nozzle, wine ring, 2 bottle stoppers and a bottle cutter, all packed in a wooden box

Packing: 5 sets | Size: 36x21x11,5 cm

Branding:

☞ 70x25mm K2+H4

☞ 50x20mm L5+H4



 For 2 bottles

without decoration



NOBLE 56-0308038

Satin stainless steel bottle holder "Noble": for decorative presentation of wine bottles and other spirits, open middle part of approx. 7x16cm, firm hold through angles sides, with exposed advertising space

Packing: 10/20 pieces | **Size:** 22,5x10x10,5cm | **Material:** Stainless Steel

Branding:

☑ 70x25mm K2+H4

☑ 70x25mm L2+H4



SALUTE 56-0301036

Wine set "Salute" in wooden box: with wine thermometer made of glass, stainless steel wine ring, metal bottle stopper, and a stainless steel waiter's knife

Packing: 20 sets | **Size:** 17,5x14,5x4,5cm

Branding:

☑ 50x10mm K1+H4

☑ 170x140mm DP2+H2

☑ 16x5/Ø11mm L4+H4

☑ 35x15/28x8mm L1+H4



BORDEAUX 56-0301030

Wine set "Bordeaux" for 1 bottle in a wooden box, with wine ring, stainless steel metal nozzle, metal bottle stopper with a wooden knob, and a stainless steel waiter's knife with a wooden handle

Packing: 10 sets | **Size:** 36,3x11,2x11,2cm

Branding:

☑ 70x25mm K2+H3

☑ 50x20mm L5+H3



DUET 56-0301037

Wine set "Duet" with a waiter's knife and a bottle stopper

Packing: 50 sets |
Size: 13x10x2,5 cm

Branding:

-  20x8 mm K1+H2+V2
-  130x100 mm DP2+H2
-  11x11 mm L1+H2

**DIAMANT** 56-0301414

Bottle stopper "Diamant" with crystal design, packed in a gift box with a frosted lid

Packing: 25/75 pieces | Size: Ø3,9x10,8 cm

Branding:

-  10x4 mm L1+H2



We love wine!

**CHECKMATE** 56-0301409

Wine set "Checkmate" with chess game, consists of a waiter's knife, wine ring, wine thermometer, bottle stopper, wooden chess figures and a board game on the lid, packed in a black wooden box

Packing: 20 sets | Size: 14x17x5 cm

Branding:

-  60x12 mm K1+H4



STARDUST 56-0301019

Bottle opener "Stardust" with a wide handle

Packing: 100/200 pieces | Size: 12,5x5x2,3 cm |

Material: Stainless Steel

Branding:

☑ 35x10mm K1+H4+V2

☑ 25x10mm L1+H4

**PARTY** 56-0308039

Transparent bottle cooler "Party"

Packing: 24 pieces | Size: Ø 11,5x23,4 cm

Branding:

☑ 15x60mm K2+H3

☑ 20x50mm L5+H3

**MOSCOW** 56-0304325

Stainless steel double-walled bottle cooler "Moscow" for wine and champagne

Packing: 10 pieces | Size: Ø 12x20 cm |

Material: Stainless Steel

Branding:

☑ 25x25mm K2+H4+V1

☑ 25x25mm L2+H4

**REIMS** 56-0301026

Champagne stopper "Reims" with a practical clip mechanism

Packing: 20/200 pieces | Size: Ø 5x6,5 cm | Material: Metal

Branding:

☑ Ø 15 mm K2+H2+V1

☑ Ø 20 mm L1+H2



HAPPY HOUR 56-0304315

Stainless steel cocktail shaker "Happy Hour", approx. 300ml, packed in a gift box

Packing: 25 pieces | Size: 19xØ7,2cm | Material: Stainless Steel

Branding:

☰ 40x10mm K2+H2+V1

✂ 220x30mm LR3+H2 360°

✂ 40x10mm L1+H2

**STEEL** 56-0499040

Bottle opener "Steel": with large advertising area

Packing: 50/400 pieces | Size: 8,5x5,4 cm | Material: Stainless Steel

Branding:

☰ 25x30mm K1+H2

☰ 50x30mm DP2+H2

✂ 25x30mm L1+H2

**STEWARD** 56-1080111

Waist apron "Steward" with long strings

Packing: 100 pieces | Size: 100x100 cm | Material: 65% Polyester / 35% Cotton

Branding:

☰ 330x330 mm T2+H6

✂ 300x400 mm S6+H6



☑ Unisex

calla

GENTLEMAN 56-0304323

7 piece stainless steel hip flask set "Gentleman", consists of a hip flask (approx.: 210 ml), a funnel, 4 small cups and belt bag for the cups

Packing: 50 sets | Size: 13x9,3x2,2 cm | Material: Stainless Steel

Branding:

☪ 25x12/30x25 mm K1+H3+V1

☪ 80x40 mm DP2+H2

☪ 25x12/25x20 mm L1+H3

**SPIRIT** 56-0304309

Classic designed stainless steel hip flask "Spirit", approx. 225 ml

Packing: 20/60 pieces | Size: 14,5x9,2x2 cm | Material: Stainless Steel

Branding:

☪ 50x10 mm K1+H4+V1

☪ 80x40 mm DP2+H2

☪ 40x10 mm L1+H4

**POUR** 56-0301099

Bandolier "Pour" includes 14 plastic shot glasses with lids, adjustable shoulder strap with shoulder pad, and snap hook

Packing: 24 pieces | Size: Ø3,5x6,5/110-143cm

Branding:

☪ 10x15 mm K1+H4

**COWBOY** 56-0304344

Hip flask "Cowboy" consists of flask (approx. 150 ml capacity), funnel and 2 cups, packed in a box

Packing: 40 pieces | Size: 9x10x2 cm

Branding:

☪ 20x10 mm K1+H2+V2

☪ 80x90/80x40 mm DP2+H2

☪ 25x10 mm L1+H2



WARM-UP

Double-walled travel mug "Warm-up": made of plastic on the inside and outside, with rubber grip area, plastic lid and drink opening in the lid, approx. 400 ml capacity

Packing: 25 pieces | Size: Ø8,2x17,7 cm

Branding:

☑ 20x30mm K2+H4



☑ approx. 400ml



56-0304110
blue



56-0304111
red



56-0304112
white

LUNGO

Double-walled travel mug "Lungo": made of stainless steel on the outside and plastic on the inside, with screw-on lid and integrated drink opening, different colours, approx. 400 ml capacity

Packing: 48 pieces | Size: Ø8x17,3 cm |

Material: Stainless Steel

Branding:

☑ 20x20mm K2+H4+V2

☑ 20x20mm L1+H4

☑ 200x50mm LR3+H4 360°

☑ Approx. 400 ml



56-0304129
silver/blue



56-0304130
silver/green



56-0304128
silver/orange



56-0304131
silver/black

EVERYDAY

56-0304310

Double-walled mug "Everyday": made of stainless steel, with plastic handle, approx. 200 ml capacity

Packing: 20/80 pieces | Size: Ø6,9x8 cm |
Material: Stainless Steel

Branding:

☑ 23x25mm K2+H4+V2

☑ 160x50mm LR3+H4 360°

☑ 20x25mm L1+H4



HOT DRINK

56-0304322

Double-walled travel mug "Hot drink": with stainless steel ring on the outside and plastic on the inside, with drink opening in the lid and convenient handle, approx. 400 ml capacity

Packing: 20 pieces | Size: 19,5xØ8 cm |

Material: Stainless Steel

Branding:

☑ 20x10mm K2+H4+V1

☑ 70x30mm S7+H4

☑ 10x20mm L1+H4

☑ 170x35mm LR3+H4 360°



☑ Approx. 400 ml



CLASSICO

Double-walled mug "Classico": inside and outside made of stainless steel, plastic lid with secure screw cap, push button OPEN/CLOSE and integrated drinking opening, rubber-coated bottom for good adhesion, capacity approx. 380 ml

Packing: 28 pieces | Size: Ø6,7x18,5 cm |
Material: Stainless Steel

Branding:

- ☑ 30x30mm K2+H2+V1
- ☑ 28x28mm L2+H2

 Approx. 380 ml



56-0304150
black



56-0304151
silver



56-0304152
blue



GRAB AND GO

Double-walled travel mug "Grab and Go" made of stainless steel on the outside and plastic on the inside, with a secure screw-on plastic lid with integrated drink opening, convenient plastic handle, and rubberized stand for good surface adhesion, approx. 330 ml capacity

Packing: 48 pieces | Size: Ø7x16,5 cm |
Material: Stainless Steel

Branding:

- ☑ 20x20mm K2+H4+V2
- ☑ 20x20mm L1+H4
- ☑ 200x50mm LR3+H4 360°

 Approx. 330 ml



56-0304100
silver/black



56-0304101
black



56-0304102
green/black



56-0304103
blue/black



56-0304104
red/black



56-0304105
white/black



ON THE WAY 56-0304318

Double-walled travel mug "On the way": made of stainless steel on the outside and plastic on the inside, with convenient plastic handle and drink opening in the lid, approx. 390 ml capacity

Packing: 20 pieces | Size: 15,6xØ8,5 cm |
Material: Stainless Steel

Branding:

- ☑ 20x20mm K2+H4+V2
- ☑ 70x30mm S7+H4
- ☑ 150x35mm LR3+H4
- ☑ 20x20mm L1+H4



 Approx. 390 ml



ARABICA

Double-walled travel mug "Arabica" made of stainless steel on the inside and outside, contrasting colour plastic lid with a secure screwable lid, push OPEN/ CLOSE button and integrated drink opening, coloured rubber sleeve for a better grip, and rubberized stand for good surface adhesion, approx. 400 ml capacity

Packing: 24 pieces | Size: Ø6,3x19 cm

Branding:

- ☒ 25x25mm K2+H4+V2
- ☒ 180x40mm LR3+H2 360°
- ☒ 25x25mm L2+H4



Approx. 400 ml



56-0304140
white/black



56-0304141
white/light green



56-0304142
white/light blue



56-0304143
white/red



56-0304144
white/lilac

CREMA

Double-walled travel mug "Crema": stainless steel on the inside and outside, with screwable plastic lid and integrated fold-out drink opening, coloured rubber ring around the top and rubber bottom, approx. 400 ml capacity

Packing: 28 pieces | Size: Ø7x19,5 cm |

Material: Stainless Steel

Branding:

- ☒ 25x40mm K2+H4+V2
- ☒ 200x50mm LR3+H4 360°
- ☒ 28x28mm L2+H4



approx. 400ml



56-0304115
black



56-0304116
green



56-0304117
blue



56-0304118
orange



56-0304119
lilac



I need my coffee.





FLAVOURED

Travel mug "Flavoured", double-walled: inside and outside made of stainless steel, plastic lid with secure screw cap, push button OPEN/CLOSE and integrated drinking opening, capacity approx. 380 ml

Packing: 28 pieces | Size: Ø7 x 20,5 cm | Material: Stainless Steel

Branding:

- ☑ 35x35 mm K2+H4
- ☑ 25x25 mm L1+H4
- ☑ 220x100mm LR3+H4



👉 approx. 380 ml



56-0304154
dark blue



56-0304156
red



56-0304155
green



56-0304157
orange

GOLDEN DREAM

Double-walled travel mug "Golden Dream": inside and outside made of stainless steel, plastic lid with secure screwable lid, push OPEN/CLOSE button and integrated drink opening – hook on the outside to attach the lid, coloured rubber-coated silicone sleeve for a better grip, approx. 380 ml capacity, in gift box

Packing: 24 pieces | Size: Ø7 x 20,2 cm | Material: Stainless Steel/Silicone

Branding:

- ☑ 20x30 mm K2+H4
- ☑ 25x25 mm L2+H4
- ☑ 250x30 mm LR3+H4



👉 Approx. 380 ml



56-0304147
black/light blue



56-0304148
black/red



56-0304149
black/magenta



56-0304146
black/light green



AU LAIT

Doubled-walled travel mug "Au Lait": made of stainless steel on the inside and outside, coloured screwable plastic lid with drinking opening, coloured rubber ring for a better grip and rubberized stand for good surface adhesion, approx. 380 ml capacity, packed in a gift box

Packing: 28 pieces | Size: Ø6,7x18,5 cm | Material: Stainless Steel

Branding:

- ☑ 25x25mm K2+H4+V2
- ☑ 180x40mm LR3+H4 360°
- ☑ 25x25mm L2+H4



56-0304133
black/silver



56-0304134
green/silver

Approx. 380 ml



56-0304135
blue/silver



56-0304136
orange/silver



56-0304137
lilac/silver

KEEP WARM

Stainless steel vacuum flask "Keep warm": plastic spout with snap closure and screwable lid, flask body with colour application and coloured closing lid, capacity approx. 500 ml, packed in a gift box

Packing: 28 pieces | Size: Ø6,8x26,5 cm | Material: Stainless Steel

Branding:

- ☑ 25x25/15x60mm K2+H4+V2
- ☑ 180x40mm LR3+H4 360°
- ☑ 25x25mm L2+H4

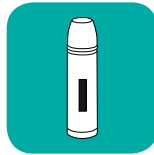

Approx. 0.5 litre



56-0304296
silver/green



56-0304295
silver/black



56-0304297
silver/blue



56-0304298
silver/orange



56-0304299
silver/purple

COME TOGETHER 56-0304337

Double-walled vacuum flask "Come Together", made of stainless steel, (450 ml) with 2 screwable cups, each cup 270 ml

Packing: 24 pieces | Size: Ø8,2x25,5 cm | Material: Stainless Steel

Branding:

- ☑ 35x15mm K2+H2
- ☑ 180x40mm LR3+H2
- ☑ 30x10mm L2+H2

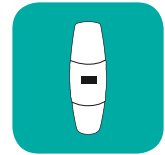

2 cups



HEAT-UP 56-0304308

Double-walled vacuum flask "Heat-up", made of stainless steel, 1 litre

Packing: 12 pieces | Size: Ø9x33 cm |
Material: Stainless Steel

Branding:

- ☑ 70x30mm K2+H4+V2
- ☑ 70x30mm S7+H4
- ☑ 20x25mm L1+H4
- ☑ 250x100mm LR3+H4 360°



1 litre

OUTDOOR

Stainless steel vacuum set "Outdoor", consists of a double-walled flask (500 ml) and 2 vacuum cups (250 ml)

Packing: 10 pieces |
Size: Ø6,7x24,7 / Ø6,3x11,7 cm |
Material: Stainless Steel

Branding:

- ☑ 30x50mm K1+H5+V2
- ☑ 180x30 / 150x80mm LR3+H5 360°
- ☑ 20x40mm L1+H5



56-0304339
blue/silver

Set

56-0304338
black/silver



BURNER 56-0411006

Metal BBQ lighter "Bumer", filled with gas, refillable

Packing: 100 pieces | Size: 17,6x1,5x1 cm | Material: Metal

Branding:

 40x8 mm K1+H2+V1

 40x8 mm L1+H2

**VESUV**

Rubber-coated BBQ lighter "Vesuv", filled with gas, refillable

Packing: 100 pieces | Size: 17,5x1,5x1,5 cm | Material: Aluminium

Branding:

 35x8 mm K2+H4+V2

 35x8 mm L2+H4

56-0411085
orange



56-0411083
yellow

**OPEN-END** 56-0411089

BBQ lighter "Open-End" with a bottle opener, white LED, hanger, filled with gas, refillable

Packing: 100 pieces | Size: 23,2x4,3x3,2 cm

Branding:

 30x15 mm K1+H3

 30x15 mm L4+H3

3x
 INCL.



 3 in 1

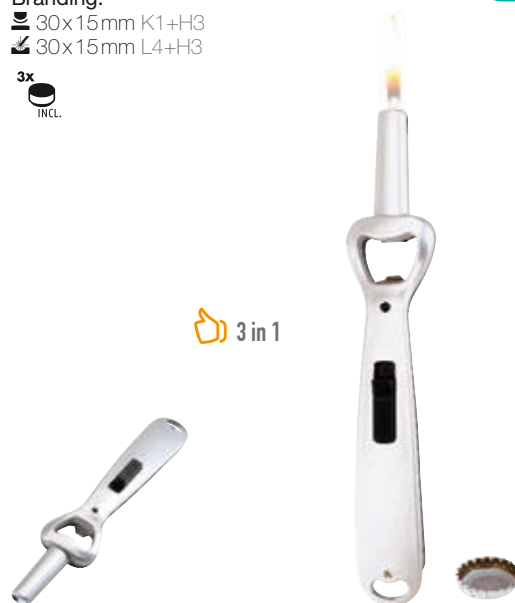

VULCANO 56-0411011

Stainless steel lighter "Vulcano" extendable, adjustable wheel for the flame, rubber-coated grip area - the neck can be pulled out to approx. 3 cm, total length when extended approx. 21 cm, filled with gas and refillable

Packing: 100 pieces | Size: 1,8x1,4x18-21 cm

Branding:

☑ 40x8mm K1+H4+V1

☑ 40x8mm L1+H4



☑ Extendable

BOW 56-0411086

BBQ lighter "Bow" with an aluminium front, rubber back, bottle opener and practical loop to hang up, filled with gas, refillable

Packing: 100 pieces | Size: 20,5x2,5x2,5 cm | Material: Aluminium

Branding:

☑ 40x10mm K1+H4+V2

☑ 40x10mm L1+H4



☑ 2 in 1

ETNA

Aluminium BBQ lighter "Etna", filled with gas, refillable

Packing: 100 pieces | Size: 17,9x1,5x1,2 cm | Material: Aluminium

Branding:

☑ 40x8mm K1+H4+V1

☑ 40x8mm L1+H4



56-0411012
silver

56-0411014
black

FUEGO

Stick lighter "Fuego": with safety button, small control wheel to adjust the flame size, iron tube and plastic casing, window to check the contents, filled with gas and refillable

Packing: 100 pieces | Size: 19x4x2 cm

Branding:

☑ 10x30mm K1+H2



56-0411018
white

56-0411019
black

56-0411020
blue

56-0411021
red

TEIDE

Stick lighter "Teide": child-proof lock, adjustment scroller to adjust flame size and suspension hook, filled with gas and refillable

Packing: 100 pieces | Size: 22,5x3,5x2,4cm

Branding:

☰ 10x12/15x35mm K1+H2+V1



56-0411015
grey/black

56-0411016
blue

56-0411017
red

BBQ 56-0499049

Ashtray "BBQ": designed in the shape of a grill with removable grate

Packing: 25/50 pieces |

Size: 14,9x13x13cm |

Material: Carbon Steel

Branding:

☑ 25x8mm L2+H4



without decoration

GLOWING 56-0411002

Electronic lighter "Glowing" button in the middle lights up when the lighter is pushed out, USB connection for charging

Packing: 25/100 pieces | Size: 8,6x2,8x1,9cm

Branding:

☰ 15x12mm K1+H4+V1



👉 Electronic



without decoration



TRANSPARENT FASHION 56-0902171

Candle set "Transparent Fashion" includes 5 tea lights and 1 glass tea light holder, packed in a transparent box

Packing: 25/75 pieces | Size: 11,3x11,3x2,7 cm |
Material: Glass

Branding:

E1

**BLACK FASHION** 56-0902170

Candle "Black Fashion" consists of 1 candle and 1 black candle holder, packed in a transparent box

Packing: 50/100 pieces | Size: 6,7 x 6,7 x 4,8 cm

Branding:

E1

**LITTLE FLOWER** 56-0902175

Candle set "Little Flower" includes 2 vanilla perfumed candles shaped as a flower and a small glass candle holder with flower decoration, packed in a decorative box

Packing: 10/50 pieces | Size: Ø6,4x6,5 cm

Branding:

E1



Vanilla scent



GOOD LUCK

56-0902186

Tealight "Good luck" in form of the lucky pig

Packing: 200/400 pieces |

Size: Ø3,5x3,3 cm

Branding:

☐ 25x25mm E1+H1



CITRUS

Candle "Citrus Jar" in coloured metal bucket with handle – smells pleasantly

Packing: 36 pieces | Size: Ø8x7 cm**Branding:**

✂ 20x20mm L1+H2

56-0902104
blue56-0902105
pink56-0902106
yellow56-0902107
green

ATMOSPHERE

Candle set "Atmosphere", consists of 3 perfumed tea lights, 1 glass tea light holder and scented sticks with ceramic holder in the shape of a leaf, packed in a gift box with a frosted lid

Packing: 50/100 pieces | Size: 20,2x7,5x3,3 cm**Branding:**

☐ 65x15mm K1+H2

☐ 202x70mm DP2+H2

56-0902137
apple56-0902138
lemon56-0902136
orange



FOREVER LOVE 56-0902187

Candle holder "Forever Love", made of milk glass with decorative heart motif, 2 tea lights with red wax included

Packing: 50/100 pieces | **Size:** Ø4,25x6,2cm |
Material: Glass

Branding:
☑ Ø30mm K1

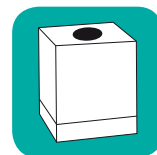

2 HEARTS 56-0902180

Candle set "2 Hearts" consists of 2 red vanilla perfumed candles and a heart-shaped holder, packed in a gift box with a transparent frosted lid

Packing: 50/100 sets |
Size: 13x9,5x2,5 cm

Branding: ☑ 15x15mm K1
☑ 130x95mm DP2+H2



☑ Vanilla scent



GOOD SPIRITS 56-0902115

Vanilla perfumed candle "Good spirits" in heart-shaped metal tin

Packing: 100/300 pieces |
Size: 5x5x2,4 cm

Branding:
☑ 25x15mm K1+H2+V2
☑ 50x50mm DP2+H2
☑ 25x15mm L1+H2



☑ Vanilla scent

SWEETHEART 56-0902179

Candle "Sweetheart", heart-shaped vanilla perfumed candle packed in a transparent gift box

Packing: 200/400 pieces |
Size: 5,2x5,2x2,7 cm

Branding:
☑ 10x10mm K1

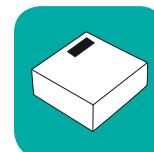

☑ Vanilla scent

ESSENCE

Candle set "Essence", consists of 2 perfumed candles and flower-shaped glass holder, packed in a gift box with a transparent frosted lid

Packing: 50/100 pieces | **Size:** 13x8,2x2,5 cm

Branding:

-  15x15mm K1+H2
-  130x80mm DP2+H2
-  10x10mm L4+H2



56-0902176
lavender

56-0902177
rose

56-0902178
jasmine

NUANCE 56-0902144

Candle set "Nuance" consists of a scented candle, 8 scented cones, 6 scented sticks with ceramic holder shaped as a leaf, packed in a gift box

Packing: 50/100 pieces |

Size: 15,7x8,3x3,2 cm

Branding:

-  30x20mm K2
-  150x80mm DP2+H2
-  40x20mm E1





SILENCE 56-0902148

Scented candle set "Silence" includes scented sticks with ceramic stand, 1 bag of potpourri, 1 bottle of scented oil, ceramic lamp, 2 tea lights, packed in a gift box

Packing: 30 sets | **Size:** 25x15x7 cm

Branding:

-  25x15mm K1
-  40x20mm E1



 Fragrant and relaxing





BEAUTY FLAVOUR 56-0909300

Room fragrance "Beauty Flavour" – decorative glass with shimmering black bottom, various reed sticks and a flower, filled with aromatic jasmine oil in transparent bottle (approx. 100 ml), packed in box with paper inlay

Packing: 12/24 pieces | **Size:** 10x7x25 cm

Branding:

☐ 40x20mm E1



SWEET FLAVOUR 56-0909302

Room fragrance "Sweet Flavour" – decorative glass bottle (ca. 50 ml) filled with aromatic vanilla oil, reed sticks

Packing: 56/112 pieces | **Size:** 4,5x3,6x17,5 cm

Branding:

☐ 30x20mm E1



PRETTY FLAVOUR 56-0909301

Room fragrance "Pretty Flavour" – decorative glass in purple colour, various reed sticks and a flower, filled with aromatic lavender oil (approx. 80 ml), packed in box with paper inlay

Packing: 20/40 pieces | **Size:** 6,5x6,5x18 cm

Branding:

☐ 40x20mm E1



TEA TIME 56-0902337

LED Tealight "Tea Time" with integrated LED light and ON/OFF button on the bottom

Packing: 24/288 pieces | Size: Ø3,8x1,8cm

Branding:

15x10mm K1+H2

1x
INCL.



TOUCH ME 56-0903069

Lamp "Touch Me" with a touch-sensitive stand to switch on/off and dim the lamp (3 levels), white shade and a 230 Volt connection, packed in a gift box

Packing: 20 pieces | Size: Ø12,4x30,5 cm |

Material: Stainless Steel

Branding:

15x10mm L2+H7

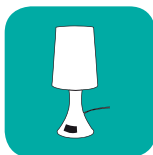

On/Off by the
touch of a finger



BIG GLINT 56-0902324

LED light "Big glint" shaped as a cylinder with removable LED light which can be turned ON and OFF

Packing: 50/200 pieces |
Size: Ø4,5x9,7 cm

Branding:
15x40mm K1+H4

**SMALL GLINT** 56-0902325

LED light "Small glint" shaped as a cylinder with removable LED light which can be turned ON and OFF

Packing: 50/200 pieces | Size: Ø4,5x5,8 cm

Branding:
15x25mm K1+H4

**VANILLA SKY** 56-0902335

LED candle "Vanilla sky" with vanilla scent, ON/OFF button on the bottom

Packing: 24 pieces |
Size: Ø7,5x12,5cm | Material: Wax

Branding:
40x20mm E1+H4



AAA/LR03/AM4

 Vanilla scent



FOR TWO

56-0402350

Massage heart "For Two" with three balls

Packing: 100/200 pieces |

Size: 11,7x11,7x4cm

Branding:

☐ 20x20mm K1+H2

☐ 20x20mm DP1+H2



*I enjoy with
all my senses.*



STARFISH

Massage "Starfish" with five balls

Packing: 50/100 pieces | Size: Ø 14x3cm

Branding:

☐ Ø 25mm K1+H2

☐ 25x25mm DP1+H2



56-0402351
blue



56-0402352
red



56-0402354
green



56-0402356
transparent

GOOD FEELING 56-0320010

Wellness set "Good Feeling" packed in a transparent bag with zip, consists of a bottle of bath salt, pumice stone, nailbrush and a sponge

Packing: 25/50 sets | **Size:** 20x13x5,5 cm

Branding:

☑ Ø40mm K1+H5

**SWEET HARMONY** 56-0320015

Wellness Set "Sweet Harmony" consists of a pumice stone, sponge and a nailbrush, packed in a gift box

Packing: 50/100 sets | **Size:** 10x9x5,4 cm

Branding:

☑ 10x10/60x20mm K1

☐ 60x20mm E1

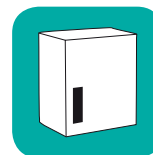
**NATURAL** 56-0320022

Massage set "Natural": consisting of massage band, massage hand pad with suspension clip, loofah sponge and hand brush, in ecological packaging

Packing: 25 sets | **Size:** 21 x 15,5 x 6 cm

Branding:

☑ 30x20mm K1



KARMA 56-0605028

Yoga mat "Karma" with non-slip floor adhesive coating, in bag with pullable cord and plastic stopper, adjustable shoulder strap

Packing: 12 pieces |
Size: 183x61x0,4cm

Branding:

🔊 80x80mm F2+H5
 🎵 80x80mm T1+H5

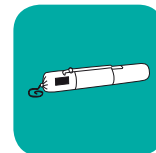
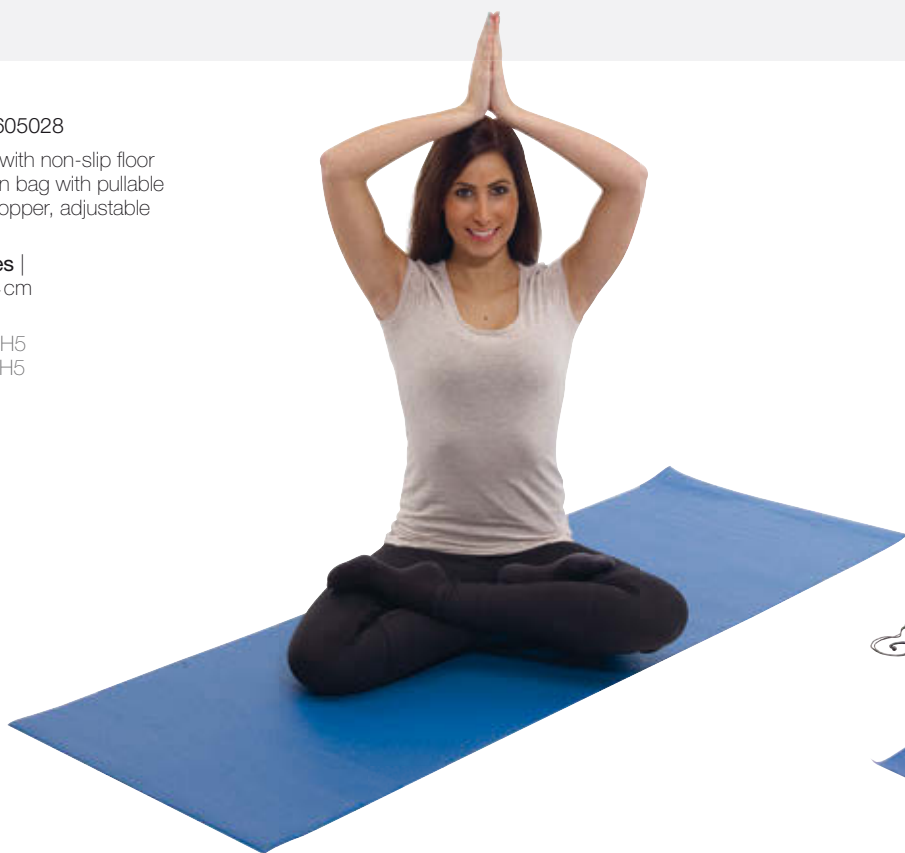
**FIT** 56-0605016

Inflatable exercise ball "Fit" made out of stable PVC, 30" deflated, with a pump

Packing: 10 pieces | **Size:** Ø70cm

Branding:

🎵 70x12mm K2+H7



Relax!



ACTIVE 56-0605019

Gymnastics set "Active", 7 pieces: consisting of stretch band, skipping rope with counter, 2 weight bandages with finger loop and Velcro fastener, 2 hand muscle trainer, in zip fastening bag with Velcro carrying handle

Packing: 5 pieces | **Size:** 40x28 cm

Branding:

80x60/150x95mm T2+H7

**STRONGER**

Barbell "Stronger" with non-slip surface – gentle on floor and maximum grip while handling – weight: approx. 1.5 kg – suitable for fitness and rehabilitation

Packing: 6 pieces | **Size:** Ø10x16 cm

Branding:

20x20mm K2+H4+V1

20x20mm L4+H4



56-0605040
blue

56-0605041
magenta

Approx. 1.5 kg

RUN AWAY 56-0406094

Pedometer "Run away" with LCD display for calories burnt and steps counted, distance is measured in kilometres and miles, fastening clip

Packing: 100/400 pieces |
Size: 6,2x5x2,3 cm

Branding:
 22x15 mm K2+H4



EASY RUN

Pedometer "Easy Run" with LCD display showing number of steps taken, rubber-coated on and off button, with belt clip on the back

Packing: 200/400 pieces |
Size: 4,8x3,6x1,9 cm

Branding:
 15x5 mm K1+H5



56-0406106
white



56-0406108
green



56-0406107
blue

SOLAR RUNNER 56-1803006

Solar pedometer "Solar Runner" with a clip on the back, LCD screen with steps already made, distance in km, time in minutes, burnt calories, solar panel

Packing: 50/200 pieces | **Size:** 5,2x4,5x2,3 cm

Branding:
 20x12 mm K2+H4
 20x10 mm DP1+H2



Solar



SAFER SUN 56-1803004

UV measuring device "Safer Sun" to determine the UVA and UVB radiation, wavelength range 290 to 390 nm with a digital screen (°C and °F) and a lanyard

Packing: 50/100 pieces |
Size: 6,4x4,9x1,9 cm

Branding:
 25x9 mm K2+H3



UV measuring device



WASP-WAIST 56-0403256

Body measuring tape "Wasp-waist" to determine Body Mass Index, 150 cm, packed in a black box

Packing: 100/200 pieces | Size: Ø7,3x2,5 cm

Branding:

📦 Ø15/30x20 mm K1+H3



👉 With Body Mass Index

**TAKE IT EASY** 56-1802003

Body fat calipers "Take it easy" for measuring your body fat content, with a LCD display, beep once the measurement has been completed

Packing: 25/50 pieces | Size: 15,2x7,5x4 cm

Branding:

📦 20x8/8x8 mm K2+H5



FINESSE
PRODUCTS FOR WELL BEING

**ATHLETIC** 56-0605029

Digital skipping rope "Athletic": display with 4 different display modes: number of jumps, calorie consumption (CAL), distance covered in kilometres (KM) and miles (MIL), 2 operating buttons, press mode button to switch display modes, adjustable rope length (approx. 3,05 m)

Packing: 50/100 pieces |

Size: 17,5x3,5x3/295 cm

Branding:

📦 40x10 mm K1+H2

📏 15x10 mm L5+H2



 **NEW**





SUNRISE 56-1804003

Season light "Sunrise" creates the perfect mood for those dark days, includes a power supply, time display and different light settings

Packing: 10/20 pieces | Size: 12,5x6,5x2 cm

Branding:

 10x8mm K1+H3



 Enlightens the mood



i Especially in the dark season a lot of people suffer from lack of light. This may result in winter depressions or sleep disorders. Light therapies may prevent this and help.

TOP FIT 56-1803003

Muscle stimulation device "Top Fit" with 16 training programmes, 4 electrodes, 2 electrode cables, includes an instruction manual and carrying bag

Packing: 10 pieces

Branding:

 20x12mm K2+H4

 80x50mm T2+H2

 20x12mm L4+H4



AAA/LR03/AM4



BODY SHAPER 56-1803002

Fitness belt "Body Shaper" supports the abdominal muscles, with 5 training programmes, adjustable intenseness, comfortable belt, includes an instruction manual

Packing: 5/15 pieces | Size: 111x15 cm

Branding:

 20x10mm K2+H6



AAA/LR03/AM4

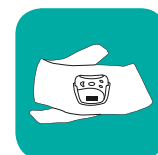

RECOVERY 56-1801001

Thermometer "Recovery" with a LCD screen, 10 seconds measuring time, from 32°C to 43°C, acoustic sound when the measurement has been completed, packed in a protective plastic holder

Packing: 25/100 pieces |
Size: 13,3x2,7x1,5cm

Branding:

10x 15mm K1+H2



FINESSE
PRODUCTS FOR WELL BEING



10 seconds measuring time

SAFE + SOUND 56-1801002

Thermometer "Safe + Sound" with a LCD screen, 60 seconds measuring time, from 32°C to 43°C, acoustic sound when the measurement has been completed, packed in a protective plastic holder

Packing: 25/100 pieces |
Size: 13,3x2,3x1,5cm

Branding:

10x 15mm K1+H2

100x20mm DP2+H2



FINESSE
PRODUCTS FOR WELL BEING



60 seconds measuring time



I like to keep fit.

**HEARTBEAT** 56-1801004

Blood pressure measuring device "Heartbeat" for your wrist, measures from 20 to 280mm/HG, approx. 200 memory capacity, with Velcro wristband, packed in a practical container

Packing: 25/50 pieces | Size: 6,9x6,6x6cm

Branding:

40x25mm K2+H4+V1



AAA/LR03/AM4



FINESSE
PRODUCTS FOR WELL BEING



The optimal blood pressure values for an adult lie around 120/90 mm/Hg.

AMELIE 56-0499094

Elegant manicure set "Amelie", consists of a pair of nail scissors, nail file, tweezer, manicure stick, small and large nail clippers, packed in a rectangular pouch with a button on the side

Packing: 20/80 pieces |

Size: 15,3x7,5x2,3cm

Branding:

☞ 70x30mm K1+H3

☞ 70x30mm DP2+H2

**MARSEILLE** 56-0499007

Manicure set "Marseille" consists of a pair of nail scissors, nail file, manicure stick and nail clippers packed in an oval aluminium box

Packing: 10/100 pieces | Size: 12x4,5x3cm

Branding:

☞ 40x20mm K1+H4+V1

☞ 35x15mm L1+H4

**DENISE**

Elegant manicure set "Denise", consists of a pair of nail scissors, nail file, tweezer, nail clippers, 2 manicure sticks, packed in an oval pouch with a button on the side

Packing: 20/100 pieces | Size: 12,4x7,5x2,1cm

Branding:

☞ 60x30mm K1+H3

☞ 80x40mm DP2+H2

☞ 60x30mm T1+H3



56-0499092
black

56-0499096
beige



*I feel like a
beauty queen!*



TRAVEL COMPANION 56-0499098

Manicure and sewing kit "Travel Companion" consists of nail file, tweezers, nail scissors, nail clippers, and inner pocket with sewing kit with needles, 6 threads of different colours, safety pin, and 2 buttons, in a notebook-like case with aluminium frame, elastic strap closure, and metal plate for your advertising

Packing: 50 pieces | Size: 12,2x9,9x2,4 cm

Branding:

☑ 35x15mm K2+H4+V2

☑ 35x15mm L2+H4



ELAINE

Manicure set "Elaine", consists of a pair of nail scissors, nail file, tweezers, nail clippers, 2 manicure sticks packed in a pouch with press stud

Packing: 50/200 pieces | Size: 11x6x1,8 cm

Branding:

☑ 30x30mm K1+H2

☑ 30x30mm L4+H2



56-0499093
red



56-0499095
black

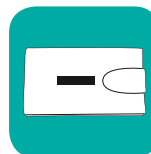

PERFECT 56-0499003

6-piece manicure set "Perfect" consists of a nail file, tweezers, nail cuticle scissors, 2 nail clippers, a pair of scissors, packed in a pouch with a zip, coloured seams and a metal plate for engraving your logo

Packing: 25/50 pieces |

Size: 14,8x8,9x3 cm

Branding:

☑ 40x20mm P1+H3

☑ 30x10mm L1+H3



DENTIST 56-0402440

Toothpicks "Dentist" with a small brush, packed in a frosted flat box

Packing: 100/500 pieces | Size: 4,8x7x0,6cm

Branding:

☺ 30x20mm K1+H2+V1

☹ 30x20mm DP1+H2



 With small brush

CARE

Nail file "Care" packed in a frosted box

Packing: 50/500 pieces |

Size: 14,5x2,9x0,9cm

Branding:

☺ 45x10mm K1+H3

☹ 45x10mm DP1+H2

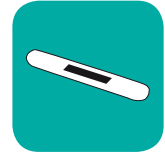

56-0402441
blue



56-0402442
pink



My feet are in excellent shape.



PRETTY WOMAN 56-0320017

Pedicure set "Pretty Woman": consists of 1 nail file, 2 foam toe separators, nail brush, pumice stone, transparent zipper bag with carrying strap

Packing: 60/120 sets | Size: 14x4,5x6cm

Branding:

- 40x20mm E1
- 80x30mm E3

**DANDELION** 56-0320018

Mini nail files "Dandelion": 6 mini nail files, in paperboard folder

Packing: 100/1000 pieces |
Size: 5,5x6,2x0,4 cm

Branding:

- 40x9/35x35mm K1+H2
- 40x20mm E1

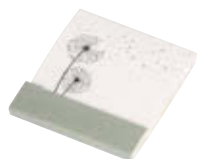
**EASY CARE** 56-1802004

Manicure/pedicure set "Easy Care" consists of a wireless, rechargeable hand appliance, 12 different attachments (nail file, polisher and rub down attachments, brush, nail stick) for your nails and toe nails and for the removal of hard skin, with a whirlpool to soften your nails and a ventilator for drying your nails, with a 230 Volt connection

Packing: 4 pieces | Size: 28x19x12 cm



DONNA 56-0402335

Aluminium pocket mirror "Donna", in the size of a business card

Packing: 50/500 pieces | Size: 6x7x0,5cm | Material: Aluminium

Branding:

-  45x10mm K1+H2+V1
-  60x60mm DP2+H2
-  45x10mm L1+H2

**DIVA** 56-0402336

Handy make-up mirror "Diva" with LED light

Packing: 50/200 pieces | Size: Ø7x1,6 cm

Branding:

-  Ø 25mm K1+H2
-  25x25mm DP1+H2
-  25x25mm L4+H3
-  Ø 25mm L1+H2

4x
 INCL.



 With LED light

**ELVIS** 56-0402316

Foldable travel hairbrush "Elvis" with mirror

Packing: 30/300 pieces | Size: 21x4x2,5cm

Branding:

-  40x15mm K1+H2
-  40x15mm DP1+H2

**MAGNIFY** 56-0402338

Make-up mirror "Magnify" with 2 mirrors, rubber lid and a magnifying mirror

Packing: 50/300 pieces | Size: Ø6,6x1,5 cm

Branding:

-  30x20mm K1+H3+V1
-  Ø 30mm DP1+H2
-  30x20mm L4+H3

 With magnifying mirror

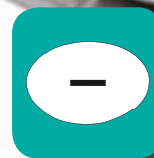

STEP ON 56-0499084

Digital personal scale "Step on": measurement range from 5 to 150 kg, with 0,1 kg division, switchable from kg to lbs, charging and battery level indicator, automatic on/off function, with glass surface and non-slip feet



Packing: 10 pieces | Size: 28x29x2,7 cm

Branding:

☑ 30x10mm K2+H5+V2

☑ 30x10mm L5+H5



🔥 Up to 150 kg

**BETTY** 56-0503021

Squeaky vinyl duck "Betty" for the bath

Packing: 60/240 pieces | Size: 8x10x10 cm

Branding:

☑ 20x10mm K1+H2+V2

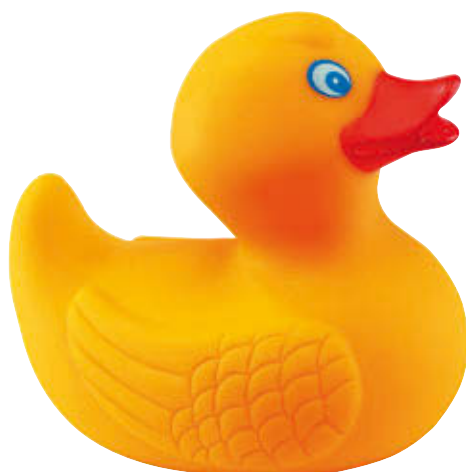
**BOB** 56-0503025

Squeaky vinyl duck "Bob" with a blue overall and cap

Packing: 50/200 pieces |

Size: 7x9x9 cm

Branding:

☑ 20x10mm K1+H2+V2



DALLAS 56-0503026

Water Basketball "Dallas" ideal for the bath, 1 net basket with suction cups and 2 balls, packed in a gift box

Packing: 24/72 pieces |

Size: Ø 12,5 x 10,5 / Ø 5,5 cm

Branding:

☐ 40x20mm E1



Ideal for the bathtub

**KROKETT** 56-0502229

Bath thermometer "Kroket": crocodile with swimming ring, temperature indicator - appears through contact with warm water, packed in a gift box

Packing: 48 pieces | Size: Ø 8 x 8 cm

Branding:

☑ 10x5mm K2+H2

**WARM STAR** 56-0909008

Pocket warmer "Warm Star", by clicking the metal plate and kneading, the star supplies heat for approx. 20 minutes - before the next use just put the star in very hot water for approx. 5 minutes, weights approx. 62 g

Packing: 80/160 pieces | Size: 11 x 11 cm

Branding:

☑ Ø 25 mm K1+H2

☑ Ø 35 mm DP1+H2

**WARM HEARTED** 56-0909006

Pocket warmer "Warm hearted", by clicking the metal plate and kneading, the heart supplies heat for approx. 20 minutes - before the next use just put the heart in very hot water for approx. 5 minutes, weights approx. 62 g

Packing: 80/160 pieces | Size: 9 x 9 cm

Branding:

☑ 40x20mm K2+H2+V1

☑ 40x25mm DP1+H2



FROZEN FLOWER

Cooling pad "Frozen Flower": with gel pellets, ideal for small injuries or toothache – to be stored in refrigerator

Packing: 60/240 pieces | Size: 10x10 cm

Branding:

40x30mm K2+H2+V2

Ø30mm DP1+H2



56-090917
red



56-090915
transparent



56-090916
blue



FROZEN 56-090918

Cooling bag "Frozen" with screwable lid – simply fill with ice cubes and cool the painful body area

Packing: 50/200 pieces | Size: Ø14x7 cm

Branding:

Ø40mm K1+H4+V1



CLEAN UP 56-0407711

Microfibre glasses cleaning cloth "Clean up"

Packing: 2000 pieces | Size: 18x15 cm |

Material: Polyester

Branding:

☰ 135 cm² TS3

**VIEW** 56-0407710

Glass cleaner set "View", spray bottle with cleaning fluid (approx. 20 ml), glass cleaner cloth, mini screwdriver with key ring, in PVC bag with press stud

Packing: 100/200 pieces | Size: 3,5x3x10 cm

Branding:

☰ 25x9mm K1+H3

**CLEANER**

Microfibre cloth "Cleaner": highly absorbent and quick drying, with soft surface structure, in colour-coded mesh bag with pullable cord and plastic stopper

Packing: 50/100 pieces |

Size: 31,5x31/Ø 13,5x16,5 cm | Material: Polyester

Branding:

☰ 65x35mm T1+H4

☞ 280x280mm N1+H4

Microfibre



56-0605001
black/white



56-0605002
blue



 Highly absorbent
and quick drying



56-0605003
orange





MOP UP

Duster "Mop up" with light expandable stainless steel rod, rubber-coated grip, and electrostatic fiber fabric for optimal dust removal

Packing: 25/100 pieces | **Size:** 27-74 cm

Branding:

☑ 30x5 mm K1+H2+V2

☑ 30x5 mm L4+H2



56-0909012
blue

56-0909013
pink

56-0909014
green



BLOCK 56-0909007

Door stopper "Block" with carrying handle and zipper on the bottom for easy filling

Packing: 90/180 pieces | **Size:** Ø12x14 cm

Branding:

☑ 40x25 mm T1+H2



☑ Own filling



VIVIENNE 56-0405281

Sewing and manicure set "Vivienne"

Packing: 50/250 pieces | Size: 10x6,5x1,5 cm |

Material: 70D Nylon

Branding:

☞ 40x15mm K1+H2

☞ 40x15mm T1+H2

**TAILOR** 56-0405296

Travel sewing kit "Tailor" in business card format

Packing: 50/500 pieces | Size: 8,5x5,5x0,5 cm**Branding:**

☞ 70x10mm K1+H2

☞ 80x50mm DP2+H2

**FUZZY** 56-0402300

Clothes brush "Fuzzy": with integrated sewing kit consisting of 2 needles, 4 buttons, and variegated sewing threads – to renew adhesive function, clean brush with water – cap with key chain, cap can be attached backwards to function as a handle, extended size approx. 15.5 cm

Packing: 120/480 pieces |

Size: Ø2,4x15,5 cm

Branding:

☞ 60x10mm K1+H2

☞ 60x7 mm DP1+H2





POLISH 56-0405185

7 piece shoe cleaning set "Polish", consists of 3 wooden brushes, lint brush, cleaning cloth, sponge and colourless shoe polish, packed in a zip pouch

Packing: 25/50 pieces | **Size:** 17x10x6cm | **Material:** 80D Nylon

Branding:
 140x70mm T2+H5

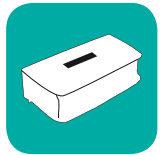

SCRAPE

Back scratcher "Scrape" with a shoe horn and a hanger

Packing: 150/300 pieces | **Size:** 37,5x2,5cm

Branding:
 45x20mm K1+H2



SLIP IN

Shoehorn "Slip in" with integrated loop for hanging and prominent advertising space

Packing: 100/600 pieces | **Size:** 18,9x4,2x1 cm

Branding:
 25x40mm K2+H2+V1



GLOBAL 56-0402714

Travel adaptor "Global" with 3 plugs, for UK, Europe, USA, Asia and Australia

Packing: 50/100 pieces | Size: Ø4,8x8,5 cm

Branding:

☞ 12x10mm K2+H4



☞ All - purpose

**TRAVEL MATE** 56-0402713

Travel adaptor "Travel Mate" with switching controller for UK, Europe, USA, Australia, and Asia, fold-out plugs, 2 USB charging ports each with 2,1 A output for e.g. smartphones, tablets etc., in colour matching storage box

Packing: 30/60 pieces | Size: 6x4,5x5,6 cm

Branding:

☞ 45x45mm K1+H2+V1

☞ 25x25mm L4+H2

☞ 45x45mm L5+H2

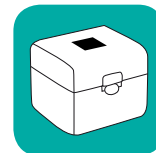
**EASY CUT** 56-0402860

Tablet divider "Easy cut" with small knife on the inside which divides the tablet when you close the box

Packing: 50/300 pieces | Size: Ø7x2,5 cm

Branding:

☞ 25x12mm K1+H2

☞ 25x10mm DP1+H2



without decoration

DAY BY DAY 56-0402861

Pill box "Day by day" with 7 compartments, rotates by a push of the button, transparent fold-out side for removing the tablets

Packing: 50/200 pieces | Size: Ø8,8x3,8 cm

Branding:

☞ 25x15mm K1+H2



without decoration

PERFECT DREAM

"Perfect Dream" soft sleeping mask, total coverage of the eyes with satin on the outside, soft polyester terry on the inside, filled with soft foam pellets, adjustable elastic band with plastic closure

Packing: 100/400 pieces | Size: one size

Branding:

80x30mm T1+H3



56-0703003
silver

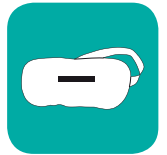

56-0703001
navy blue



56-0703002
black



TURN OVER 56-0607000

Bolster "Turn Over": versatile – can be transformed into a travel neck pillow by opening the zip, filled with plastic beads for optimal shape, closure with snap fastener – ideal travel pillow, head, neck, and back support

Packing: 10 pieces | Size: 36x31 / Ø 16x35 cm | Material: 93% Polyester / 7% Spandex

Branding:

100x30mm T1+H2



With snap fastener.



COMFORTABLE

Inflatable travel pillow "Comfortable" with a pouch

Packing: 25/100 pieces | Size: 35x23x9 cm

Branding:

100x80mm T2+H4

60x35mm T1+H4



56-0402701
blue



56-0402702
dark red



56-0402707
grey



SERVICE & QUALITY

OFFICE & BUSINESS

MUSIC & TIME

LIGHTS & TOOLS

SAVE & PRACTICAL



TRAVEL & HOLIDAY

➤ *„I am where the action is.“*

I want to experience life during my travels. I get into gear with my suitcases. On top, I take a backpack as my carry-on luggage. That way, I have enough space for my favourite clothes and can still shop for souvenirs.



ROM 56-0204448

Trolley board case "Rom" with packing area on both sides, inside full lining with packing divider and packing strap, telescopic trolley system, carrying handle, 4 easy running wheels, combination lock - boarding size

Packing: 1 piece | Size: approx. 55x33x22 cm | Material: ABS

Branding:
✂ 18x18mm L2+H9

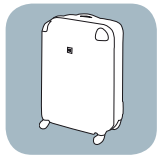
**LIVERPOOL** 56-0204501

Travelling set "Liverpool" consists of 3 pieces, board case with telescopic trolley system, expandable zipper for more packing space, full inner lining with straps, cosmetic bag with adjustable and removable shoulder straps and reporter function to fasten to the trolley, spacious toilet bag with carrying handle

Packing: 1 set | Size:

- 1 approx. 26x18x9 cm
- 2 approx. 32x25x18 cm
- 3 approx. 55x38x22 cm | Material: 600D Polyester/EVA

Branding:
✂ 50x30mm T1+H6
✂ 20x10mm L3+H6

**VERONA** 56-0204449

Trolley board case "Verona" with packing on both sides, inside full lining with packing divider and straps, telescopic trolley system, carrying handle, 4 easy running wheels, combination lock, boarding size suitable for low budget airlines

Packing: 1 piece | Size: approx. 35x20x55 cm | Material: ABS

Branding:
✂ 18x18mm L2+H9



PADUA

Trolley board case "Padua" with packing area on both sides, inside full lining with zippered packing divider and straps, lockable telescopic trolley system, carrying handle, 4 smoothly running wheels, combination lock – boarding size suitable for low budget airlines

Packing: 1 piece | Size: approx. 55x35x20 cm | Material: ABS

Branding:

✂ 50x30mm L2+H8



56-0204455
black



56-0204456
white



56-0204464
turquoise



56-0204466
light green



56-0204465
pink



ST. TROPEZ 56-0204450

Trolley boardcase "St. Tropez" with packing area on both sides, inside full lining with divider and packing strap, lockable and retractable trolley system, 2 handles, 4 side feet, 4 easy running wheels, combination lock, boarding size suitable for low budget airlines

Packing: 1 piece | Size: approx. 55x40x20 cm | Material: polycarbonate/ABS material mix

Branding:

✂ 50x30mm L2+H8



 XS boarding size

DUBLIN 56-0204516

Trolley "Dublin" packing area with lining, extra zip pocket, packing strap, 2 zip front pockets, telescopic trolley system, carrying handle, easy running wheels, combination lock, address label on the back, exchangeable metal logo, boarding size suitable for low budget airlines.

Packing: 1 piece | Size: approx. 50x35x20 cm | Material: 600D Polyester/EVA

Branding:

✂ 20x10mm L3+H6



PLAYER 56-0204457

Trolley board case "Player": case in wooden look with Ludo game area, including pawns and dice in cotton bag, with packing area on both sides, inside full lining with mesh pocket packing divider, main compartment with packing strap and zippered pocket, lockable telescopic trolley system, carrying handle, 4 smoothly running wheels, combination lock, XS boarding size suitable for low budget airlines

Packing: 1 piece |

Size: approx. 55x40x20cm/34 L/2,7 kg |

Material: polycarbonate/ABS material mix

Branding:

150x25mm S2+H8+V3



Incl. game pawns



FRANKFURT 56-2202510

Business trolley boardcase "Frankfurt": lockable and retractable telescopic system, 2 ball bearing skater wheels, front pocket for direct access to shock absorbing compartment for laptop/tablet PC/iPad with organizer, main compartment with packing strap and mesh-zipper pocket, soft quality handle, including 3-digit combination lock, boarding size suitable for low budget airlines

Packing: 1 piece | Size: approx. 55x37x20cm/30 L/2,8 kg |

Material: robust ABS/polycarbonate material mix

Branding:

150x150mm S6+H8+V3



XS boarding size



without decoration



LONDON

Trolley-Set LONDON 3-pcs.

- exclusive equipment and design
- good quality lockable aluminium trolley system
- packing on both levels
- with long dividers and mesh pockets on the inside
- with expandable zipper for trolley sizes L + XL to reach 10% more packing volume
- each trolley with a protection cover
- twin wheels- 360° degree turning
- incl. TSA-3-digit combination lock with address label



56-2210535-5
carbon black



Packing: 1 set |

Size:

boarding size: approx. 55x40x20 cm/29 L/2,8 kg

check in size: approx. 67x45x27 cm/72 L/4,4 kg

check in size: approx. 75x52x31 cm/110 L/5,3 kg |

Material: robust ABS/polycarbonate material mix

Branding:

40x250mm S2+H8+V3



56-2210511-5
carbon silver

56-2210514-5
orange

56-2210515-5
white



56-2210516-5
turquoise

56-2210517-5
green

56-2210519-5
purple

56-2210520-5
berry

56-2210536-5
pink

56-2210537-5
carbon red

56-2210538-5
carbon blue

56-2210539-5
carbon
champagner



CHECK.IN

*Have you already seen our
premium catalogue for luggage?*



*Verona, Rome, St. Tropez,
I'm coming!*



MANAGER 56-0203500

Business boardcase "Manager" with telescopic trolley system on skater wheels, 1 centred zipper main compartment with notebook pocket, 1 zipper rear compartment with document divider, 1 front pocket with A4 document divider and another front pocket with organizer function includes a changeable metal logo, 1 padlock and an adjustable and detachable shoulder strap

Packing: 1 piece |
Size: approx. 44x33x18-22 cm |
Material: 600D Polyester/EVA

Branding:
30x10mm L2+H9



Padded laptop compartment

SMOKING 56-0207509

Garment bag "Smoking" with stable metal hook and extra Velcro pocket, 2 carrying handles with Velcro strengthener, 2 side clips, 2 zip front pockets, 1 inside zip pocket and 2 small zip pockets, adjustable and removeable shoulder strap with shoulder pad

Packing: 20 pieces |
Size: approx. 110x55x6 cm |
Material: 600D Polyester

Branding:
300x200mm T2+H4



BASIC 56-0205501

Luggage set "Basic" consists of 5 pieces: foldable travel case, travelling bag, backpack, shopper and hip bag

Packing: 10 sets |
Size:

Branding:

- | | | | |
|---|-----------------------|---|-----------------|
| 1 | approx. 24x15x9 cm | 1 | 80x220mm T2+H8 |
| 2 | approx. 41x38x12 cm | 2 | 70x70mm T2+H8 |
| 3 | approx. 46x35x17 cm | 3 | 50x120mm T2+H8 |
| 4 | approx. 47x28x24 cm | 4 | 150x150mm T2+H8 |
| 5 | approx. 48x33x11,5 cm | 5 | 140x140mm T2+H8 |
- Material: 600D Polyester



Set



For our city trip to Berlin.



CARGO

Trolley travel bag "Cargo" on skater wheels with corner protection, U-shaped zipper on the main pocket, 2 zip front pockets with extra Velcro pockets on the outside, 1 long zip pocket on the opposite side, with top/side handles and bottom and side feet

Packing: 6 pieces | Size: approx. 75x36x34 cm |
Material: 600D Polyester

Branding:

 350x200/190x50mm T2+H4



Rib-Stop



56-0208571
black

56-0208572
black/blue

CHECKER 56-0219545

Trolley backpack "Checker" with main zip pocket and packing straps, front zip pocket with small organizer and extra zip pocket on the front, 2 side straps, 2 carrying handles, trolley system, easy running skater wheels, back zip pocket with padded slip-in pockets and ergonomically formed shoulder straps, on the back is a pocket which covers the wheels with Velcro

Packing: 6 pieces |
Size: approx. 52x32x22/33 cm |
Material: 600D Polyester

Branding:

 85x120mm T2+H2



 Backpack and trolley

AIRPACK 56-0208570

Trolley travel bag "Airpack" with a telescopic handle and skater wheels includes a corner protection, U-shaped double zipper main compartment with a zip mesh pocket inside the lid, 2 zip front pockets plus a changeable metal logo, extra side handle and address pocket, includes an adjustable and detachable shoulder strap

Packing: 6 pieces | Size: approx. 50x33x29 cm |
Material: 600D Polyester/EVA

Branding:

 200x150/200x90mm T2+H2

 20x10mm L2+H4

**VIENNA**

Trolley boardcase "Vienna": spacious main compartment with zip, zip pocket on the front, trolley system can be hidden completely in separate zip compartment, 2 carrying handles, 2 feet at the back, easy running wheels, boarding size suitable for low budget airlines

Packing: 6 pieces |
Size: approx. 55x33x20 cm |
Material: 600D Polyester

Branding:

 120x70mm T2+H2



 XS boarding size



56-0208610
black

56-0208611
blue

56-0208612
pink

ADVENTURE 56-0407077

Luggage tag "Adventure" with a hidden address card

Packing: 25/500 pieces | Size: 10,3x6,5 cm

Branding:

☞ 30x20mm K1+H2

☞ 30x20mm L4+H2



HANSA

Flight attendant "Hansa" with main zip pocket, front zip pocket, carrying handle, report function on the back, adjustable and removable strap with shoulder pad

Packing: 20 pieces |

Size: approx. 35x28x14 cm |

Material: 600D Polyester

Branding:

☞ 200x130 mm T2+H2



 With reporter function



56-0209501
black/blue

56-0209502
black/red

56-0209503
black/grey

HANSA

Trolley bag "Hansa" with spacious main zip pocket, front zip pocket, trolley system disappears in a zip pocket, carrying handle on the side, easy running skater wheels, with slide bars for going up stairs, adjustable and removable shoulder strap with padded shoulder pad and 2 carrying handles

Packing: 6 pieces |

Size: approx. 55x30x30 cm |

Material: 600D Polyester

Branding:

☞ 220x100mm T2+H4



XXL
print



56-0208502
black/blue

56-0208503
black/red

56-0208504
black/grey



COMFORTY 56-0219547

Trolley backpack "Comforty": hook and strap on the front, 1 small front zip pocket, 1 medium zip pocket, 1 large front zip pocket with padded laptop pocket and 1 interior pocket, 1 main zip compartment, 2 zip pockets with mesh pockets on the sides, slip-in pocket on the back side to store the padded and adjustable shoulder straps and dress guard, with telescopic handle – retractable into a separate zip pocket, 2 skater wheels incl. dress guard, 2 stands with shell type handle

Packing: 2 pieces | Size: approx. 33x24,5x50 cm

Branding:

☛ 80x80mm F2+H3

☛ 80x80mm T1+H3



 Padded laptop compartment



STYLO

Trolley backpack "Stylo" with a telescopic handle, easy running skater wheels includes a dust cover, corner protection, 3 front pockets with zips includes an organizer and earphone hole, 2 side pockets with zips, carrying handle, padded back and a shoulder strap

Packing: 6 pieces |

Size: approx. 48x34x20/28 cm |

Material: 600D Polyester

Branding:

☛ 100x70/120x60mm T2+H2



56-0219536
blue/black



56-0219535
grey/black



56-0219537
black/grey

GODSPEED 56-0407074

Luggage tag "Godspeed" with a fold-out address area, integrated removable ball point pen and attachment band

Packing: 50/500 pieces | Size: 9,1 x 5,5 x 0,7 cm

Branding:

☛ 40x25 mm K1+H2+V2

☛ 40x25 mm DP1+H2

☛ 40x25 mm L1+H2

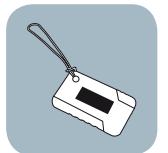

FAR AWAY 56-0407070

Luggage tag set "Far away" consists of aluminium tag with removable address field, strap with buckle to attach to luggage, and combination lock with snap hook, in metal box

Packing: 25/100 pieces |

Size: 13,1 x 8,5 x 2,1 cm | Material: Aluminium

Branding:

📏 40x15 mm K1+H2+V2

📏 100x50 mm DP2+H2

📏 40x15 mm L1+H2

📏 40x15 mm L1+H4

👉 Set



COCKPIT 56-0202601

Aluminium pilot case "Cockpit" with combination locks, textile lining, large main section, 2 flexible separation pockets, 2 slip-in pockets for business cards, 3 pen holders on the lid, includes a shoulder strap

Packing: 1/4 pieces |

Size: approx. 45,5 x 32,5 x 20,5 cm |

Material: Aluminium

Branding:

📏 40x10 mm L2+H5

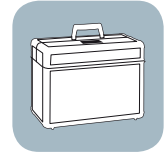

Shopping is fun!



OPAL 56-0210602

Aluminium cosmetic case "Opal", main compartment with key lock, flexible loops on the inside and side pockets, 2 extra lockable jewellery drawers on the side

Packing: 1/6 pieces |

Size: approx. 30,5 x 21,5 x 20,5 cm |

Material: Aluminium

Branding:

📏 40x15 mm L2+H5

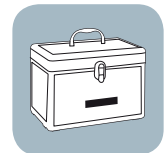

AGENT 56-0201603

Aluminium briefcase "Agent" with combination locks, textile lining and an organizer

Packing: 1/5 pieces |
Size: approx. 45,5x33x12,5cm |
Material: Aluminium

Branding:
 ☑ 40x10mm L2+H5

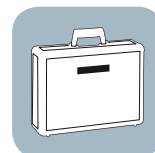
**CYBER**

Executive aluminium briefcase "Cyber" with 2 clasp key locks, organizer, suitable for notebook use, includes a shoulder strap

Packing: 1/5 pieces |
Size: approx. 44,5x32,5x10cm |
Material: Aluminium

Branding:
 ☑ 40x10mm L2+H5



56-0201604
silver



56-0201605
black

**OFFICE** 56-0202603

Aluminium pilot case "Office" on transparent easy running skater wheels, with a combination lock, telescopic handle, carrying handle, full textile lining, large main area with a padded laptop compartment, 1 net pocket and 2 slip-in pockets with a Velcro fastener, additional 4 pen loops, 1 business card pocket and net pocket on the lid

Packing: 1 piece |
Size: boarding size: approx. 48x25x36cm/38 L |
Material: Aluminium

Branding:
 ☑ 60x20mm L2+H7

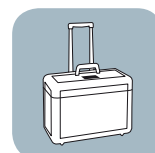

👉 Holds up to 4 files

LIFT OFF 56-0499061

Digital luggage scale "Lift off" with LCD display, measurement range up to max. 40 kg, switchable to lbs, with hold function, battery level indicator, stable suspension strap with snap buckle – for private use with applications in household and leisure activities, packed in a gift box

Packing: 50/200 pieces |

Size: 10x3,7x2,7 cm

Branding:

 15x15 mm K2+H4

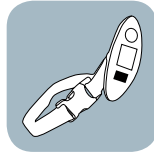

 Up to 40 kg

BALANCE 56-0216601

Multipurpose pocket scale "Balance" – max. 32 kg/75 lb, with hold function – includes an integrated measuring tape 100 cm/3 ft/39 inch – the "Multi Scale" is very useful for the household, hobby, camping and travelling purposes. Also useful for weighing your luggage and for fishing to weigh and measure the fish – for private use only

Packing: 25/50 pieces |

Size: approx. 18x8x3 cm

Branding:

 25x25 mm K1+H4



 Up to 32 kg



 In case of low budget airlines it gets expensive if you exceed the permitted baggage weight. You can already weigh your baggage at home with the luggage scale.

SUIT 56-0802206

Foldable garment bag "Suit" with zipper, comes in a storage bag with zipper

Packing: 120 pieces |

Size: approx. 100x60/29,5x20 cm |

Material: 210D Polyester

Branding:

 130x110 mm T2+H4

 150x150 mm T2+H7

 130x110 mm S1+H4

 150x150 mm S1+H7

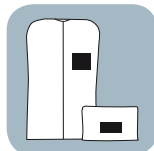

without decoration

CLEAN 56-0802205

Practical travelling garment bag "Clean", viewing window and opening for a hanger

Packing: 120 pieces |

Size: approx. 100x60 cm | Material: PEVA

Branding:

 50x20 mm K1+H2



without decoration

CLOSE 56-0216603

Combination lock "Close" shaped as a suitcase with metal wire, for safe travelling, also suitable as a padlock

Packing: 100/500 pieces |

Size: approx. 3,3x4,1x0,8cm | Material: Metal

Branding:

☞ 25x15mm K1+H2

☞ 25x15mm DP1+H2

☞ 25x15mm L1+H2

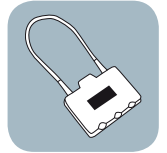
**FRESH-UP**

Toilet bag "Fresh-up": with plastic buckle on the front, inside 1 mesh zip pocket, 1 zip pocket and pockets in different sizes, metal hook to hang up

Packing: 50 pieces | Size: approx. 28x51 cm |

Material: 600D Polyester

Branding:

☞ 200x140mm F2+H2

☞ 200x140mm T2+H2

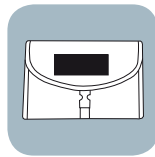

☞ For hanging



56-0810528
red



56-0810526
black



56-0810527
grey



without decoration

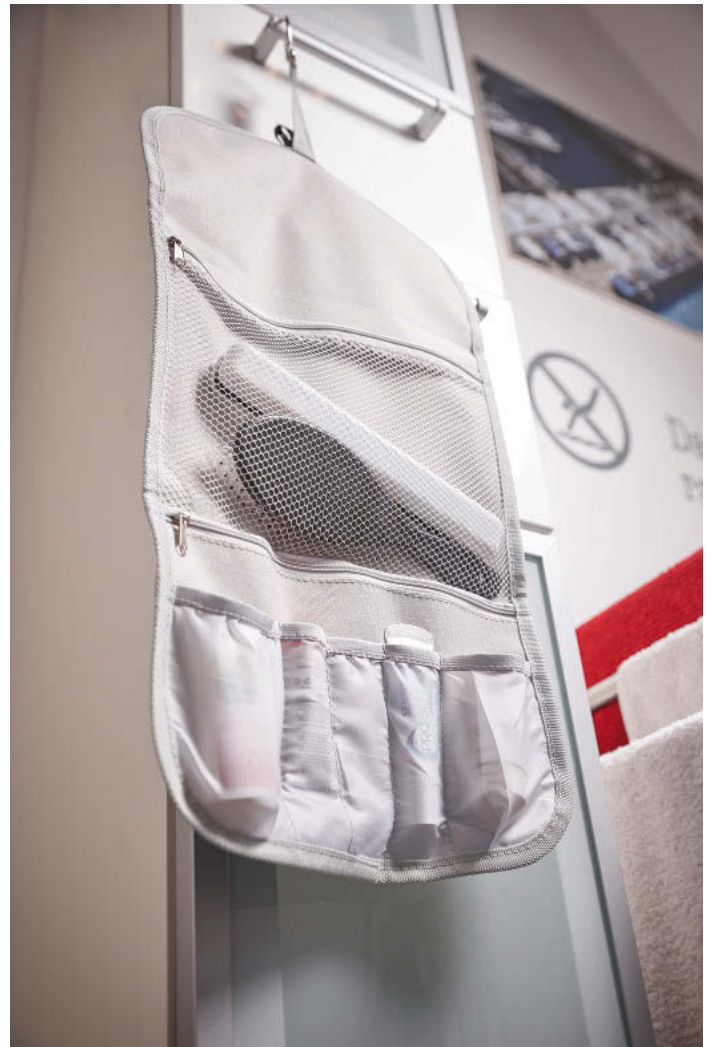

DAILY

Toilet bag "Daily" with a main pocket with a zip and inside 2 slip-in pockets, 1 front pocket with a zip and a handle with Velcro

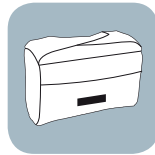

Packing: 50 pieces |

Size: approx. 30x18x13cm |

Material: 600D Polyester

Branding:

100x50mm T2+H2



56-0810503
black



56-0810504
red

NIGHT + DAY

Toilet bag "Night + Day" with main zip pocket and front zip pocket

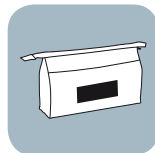

Packing: 50 pieces |

Size: approx. 28x18x8,5cm |

Material: 600D Polyester

Branding:

150x80mm T2+H2



56-0810507
black



56-0810512
light green



56-0810508
blue



56-0810509
red



56-0810510
lilac



56-0810511
turquoise

PRIME

Cosmetic bag "Prime" with 1 spacious zip pocket and 1 zip front pocket

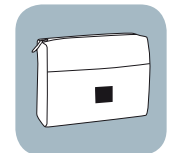

Packing: 50 pieces |

Size: approx. 27,5x21x10cm |

Material: Polyester

Branding:

80x80mm T1+H2
Microfibre



56-0810522
pink



56-0810520
black



56-0810521
turquoise



*My beauty bag
is a must!*



STAR

Cosmetic bag "Star" with 5 zip pockets, 1 detachable mirror, handle and metal hook hanger

Packing: 40 pieces |

Size: approx. 25x8x18/25x59cm |

Material: 300D Polyester

Branding:

☞ 120x60mm T2+H3



☞ For hanging



56-0810500
black



56-0810501
red



56-0810515
blue



without decoration

WIDE AWAKE 56-0810516

Toilet bag "Wide awake": with carrying handle and zip main compartment, inside 2 transparent compartments, 3 net compartments and metal hook for suspension

Packing: 50 pieces |

Size: approx. 25,5x19x8cm |

Material: 600D Polyester

Branding:

☞ 80x40mm T1+H3



☞ For hanging



without decoration

DAYBREAK

Toilet bag "Daybreak": main compartment is tightened with a metal holder and zip, inside compartment with Velcro fastener and a zipper compartment, on the outside one pocket with Velcro fastener

Packing: 50 pieces |

Size: approx. 25x17x13cm |

Material: 600D Polyester

Branding:

☞ 80x40mm T1+H2

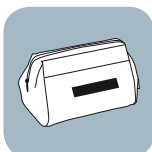

56-0810517
black



56-0810518
red



56-0810519
light blue



56-0810524
pink



without decoration



LASER PLUS 56-0207508

Garment bag "Laser Plus" with a coat hanger, carrying handle, front pocket with a zip, changeable metal logo, 2 pockets at the back with a zip, includes an adjustable and removable shoulder strap with a shoulder pad



Packing: 10 pieces |

Size: approx. 110x59x8cm |

Material: 600D Polyester

Branding:

≡ 300x150mm T2+H2

✂ 20x10mm L3+H4



without decoration

**LASER PLUS** 56-0209523

Shoulder bag "Laser Plus" with a main pocket and a front pocket with a zip, changeable metal logo, carrying handle, includes an adjustable and removable shoulder strap



Packing: 20 pieces |

Size: approx. 34x28x14 cm |

Material: 600D Polyester

Branding:

≡ 100x80mm T2+H2

✂ 20x10mm L3+H4

**LASER PLUS** 56-0210532

Cosmetic bag "Laser Plus", main pocket with zip, changeable metal logo, ABS handle, includes an adjustable and removable shoulder strap and shoulder pad



Packing: 20 pieces |

Size: approx. 35x22x28 cm |

Material: 600D Polyester

Branding:

≡ 100x80mm T2+H2

✂ 40x10mm L3+H4

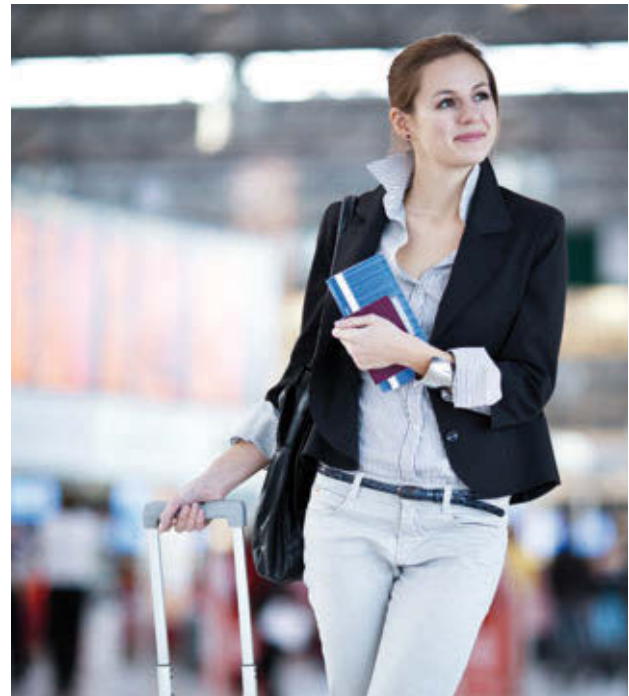

Ready for check-in?



LASER PLUS 56-0219543

Backpack "Laser Plus" main pocket and front pocket with zip, carrying handle, clip closures on the sides, padded shoulder straps and back, includes a changeable metal logo



Packing: 20 pieces |

Size: approx. 47x31x18,5 cm |

Material: 600D Polyester

Branding:

☞ 100x70mm T2+H2

☞ 40x10mm L3+H4

**LASER PLUS** 56-0208586

Travel bag "Laser Plus", main section with zip, front pocket and 2 side pockets with zip, changeable metal logo, includes an adjustable and removable shoulder strap with a shoulder pad



Packing: 20 pieces |

Size: approx. 58x28x33 cm |

Material: 600D Polyester

Branding:

☞ 150x80mm T2+H2

☞ 40x10mm L3+H4

☞ Perfect for your logo

**LASER PLUS** 56-0210533

Toilet bag "Laser Plus" with a large main pocket and a front pocket with zip and changeable metal logo



Packing: 50 pieces |

Size: approx. 30x17,5x13,5 cm |

Material: 600D Polyester

Branding:

☞ 70x40mm T1+H2

☞ 20x10mm L3+H4



SILVER LINE 56-0814539

Shoulder bag "Silver line": zippered main compartment, 1 zipper pocket on the front, adjustable shoulder strap, silver zippers, removable metal logo



Packing: 50 pieces |

Size: approx. 34x27x7,5cm |

Material: 600D Polyester

Branding:

☞ 150x150mm T2+H2

☞ 35x14mm L1+H2

**SILVER LINE** 56-0808524

Sports bag "Silver line": zippered main compartment, zippered compartment on the front, 2 small zippered pockets on the sides, carrying handles, adjustable and removable shoulder strap, silver zippers, removable metal logo



Packing: 20 pieces |

Size: approx. 50x32,5x22,5cm |

Material: 600D Polyester

Branding:

☞ 150x150mm T2+H2

☞ 35x14mm L2+H2

**SILVER LINE** 56-0819546

Backpack "Silver Line": zippered main compartment, zippered front compartment, carrying handle, padded shoulder straps and back, silver zippers, removable metal logo



Packing: 30 pieces |

Size: approx. 41x31x14,5cm |

Material: 600D Polyester

Branding:

☞ 150x150mm T2+H2

☞ 35x14mm L1+H2



RELAX 56-0805101

Sports bag "Relax" with shoe compartment and front pocket, with adjustable and detachable shoulder strap

Packing: 20 pieces |

Size: approx. 52x27,5x27 cm |

Material: 600D Polyester

Branding:

☰ 200x100/150x80mm T2+H2



☑ With shoe compartment

**RELAX** 56-0805102

Multifunctional rucksack "Relax" with organizer, mobile phone pocket, earphone hole, 2 net pockets on the side, padded shoulder straps and padded back

Packing: 20 pieces |

Size: approx. 30x16x45 cm |

Material: 600D Polyester

Branding:

☰ 100x50mm T2+H2

☰ 80x50mm T1+H2

☑ With earphone hole

**RELAX** 56-0805104

Document bag "Relax" with front pocket, mobile phone pocket, 3 pen holders, business card pocket, handle and an adjustable shoulder strap

Packing: 30 pieces |

Size: approx. 40x32x8 cm |

Material: 600D Polyester

Branding:

☰ 200x60mm T2+H2



HYPE

Rucksack "Hype" with 2 zip front pockets, one with small organizer, 2 main zip pockets with padded notebook pocket, one pocket for your portable CD player or other equipment with an earphone hole for the cable, 1 zip pocket for keys, 2 mesh pockets on the side and packing straps on the side, strong carrying handle, padded shoulder straps and reinforced back

Packing: 15 pieces | Size: approx. 46,5x31x16,5 cm |
Material: 600D Polyester

Branding:

 85x60mm T2+H2



without decoration



56-0819548
grey/black



 Padded laptop
compartment



56-0819549
black



56-0819570
blue/black



NARVIK 56-0808523

Sports bag "Narvik": zippered main compartment, 1 zippered front pocket, two small side pockets, reinforced carrying handles, adjustable and removable shoulder strap with shoulder pad

Packing: 15 pieces |
Size: approx. 72x34x26 cm |
Material: 600D Polyester

Branding:

 130x100mm F2+H3

 130x100mm T2+H3

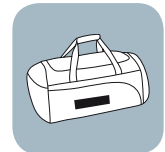

NARVIK 56-0819567

Backpack "Narvik": zipper front pocket, spacious zipper main compartment, 1 side mesh pocket, carrying handle, shoulder straps and padded back area

Packing: 20 pieces |
Size: approx. 35x18x45 cm |
Material: 600D Polyester

Branding:
☛ 180x150mm F2+H2
☛ 180x150mm T2+H2

**NARVIK** 56-0810525

Toilet bag "Narvik" with zipper front pocket for small items, zipper main compartment and carrying loop

Packing: 50 pieces |
Size: approx. 25x13x17 cm |
Material: 600D Polyester

Branding:
☛ 80x40mm F2+H2
☛ 80x40mm T1+H2

**NARVIK** 56-0805338

Laptop bag "Narvik" with zipper front pocket, zipper main compartment with 4 slip-in pockets and padded laptop pocket, carrying handle with Velcro closure, adjustable and detachable shoulder strap with shoulder pad

Packing: 20 pieces |
Size: approx. 40x10x30 cm |
Material: 600D Polyester

Branding:
☛ 230x150mm F2+H2
☛ 230x150mm T2+H2



☛ Padded laptop compartment

**NARVIK** 56-0814551

Shoulder bag "Narvik": flap with Velcro fastener, zipper front pocket, spacious main compartment, adjustable shoulder strap with shoulder pad

Packing: 30 pieces |
Size: approx. 36x10x30 cm |
Material: 600D Polyester

Branding:
☛ 160x150mm F2+H2
☛ 160x150mm T2+H2





AFRICA

Sports bag "Africa" with a zip on the main pocket, Velcro fastener on the front pocket, mesh pocket on one side, side pocket for shoes and an adjustable and removable shoulder strap with shoulder pad



Packing: 20 pieces |
 Size: approx. 62x23x31 cm |
 Material: 600D Polyester

Branding:
 300x180mm T2+H2



56-0805262
black/grey



56-0805272
brown

 With shoe compartment

AFRICA

Rucksack "Africa" with a zip on the main and front pocket, mesh pockets on each side, carrying handle, padded shoulder straps and back area



Packing: 30 pieces |
 Size: approx. 33x17x45,5cm |
 Material: 600D Polyester

Branding:
 100x100mm T2+H2



56-0805271
brown



56-0805261
black/grey

AFRICA

Shoulder bag "Africa" with a zip on the main and front pocket, flap with clip closure, a small organizer, zip on the mesh pocket, pen holders, adjustable/detachable shoulder strap with a shoulder pad

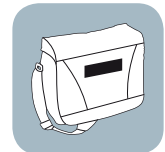

Packing: 20 pieces |
 Size: approx. 36x12,5x31 cm |
 Material: 600D Polyester

Branding:
 130x120mm T2+H2



without decoration



56-0805260
black/grey



56-0805270
brown

VINTAGE 56-0808550

Sports bag "Vintage": slip-in pocket on the front, spacious main compartment, 2 carrying handles, adjustable shoulder strap

Packing: 20 pieces |

Size: approx. 45 x 17 x 28 cm | Material: Polyester

Branding:

☛ 300x140mm F2+H2

☛ 300x140mm T2+H2



Full bags, clear mind.

**VINTAGE** 56-0819595

Backpack "Vintage": slip-in pocket on the front, spacious main zip compartment, carrying handle, with padded shoulder straps and back area

Packing: 20 pieces |

Size: approx. 30 x 14 x 41 cm | Material: Polyester

Branding:

☛ 240x230mm F2+H2

☛ 240x230mm T2+H2

**VINTAGE** 56-0814560

Shoulder bag "Vintage": slip-in pocket on the front, spacious main compartment, 2 carrying handles, adjustable shoulder strap

Packing: 20 pieces |

Size: approx. 28 x 11 x 34 cm | Material: Polyester

Branding:

☛ 240x230mm F2+H2

☛ 240x230mm T2+H2



FUSION 56-0808525

Sports bag "Fusion": zippered main compartment, zippered front compartment, reinforced carrying handles and adjustable shoulder strap

Packing: 25 pieces |

Size: approx. 50x22,5x28 cm |

Material: 600D/1680D Polyester

Branding:

 120x120mm T2+H2

**FUSION** 56-0814540

Document bag "Fusion": zippered front compartment, spacious main compartment, organizer panel, cover with Velcro closure, adjustable shoulder strap

Packing: 40 pieces |

Size: approx. 37,5x32x13 cm |

Material: 600D/1680D Polyester

Branding:

 110x120mm T2+H2

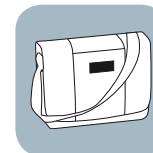
**FUSION** 56-0820546

Shopper "Fusion": spacious main compartment with press button, zippered front compartment and two shoulder straps

Packing: 40 pieces |

Size: approx. 47/42x34x9,5 cm |

Material: 600D/1680D Polyester

Branding:

 140x140mm T2+H2

**FUSION** 56-0819547

Backpack "Fusion": zippered main compartment, zippered front compartment, carrying handle and adjustable shoulder straps

Packing: 40 pieces |

Size: approx. 43x31 x13 cm |

Material: 600D/1680D Polyester

Branding:

 120x120mm T2+H2



OXFORD 56-0805337

Laptop bag "Oxford": 2 zippered outside pockets – one with organizer, 2 zippered main compartments – first with zippered mesh pocket, second with padded laptop sleeve and two additional slip-in pockets for accessories, strong carrying handle, adjustable and detachable shoulder strap with shoulder pad and a reporter function on the back

Packing: 15 pieces |

Size: approx. 40x31x16,5 cm |

Material: 420D Polyester

Branding:

☒ 35x25mm T1+H4



without decoration

 Padded laptop compartment

**SILVER RAY** 56-0809503

Reporter laptop bag "Silver Ray" with zipper front pocket with organizer, zipper main compartment with padded laptop pocket, strong carrying handle with Velcro closure, adjustable and detachable shoulder strap, reporter function on the back

Packing: 15 pieces |

Size: approx. 42x5,8x31 cm |

Material: 1680D Polyester

Branding:

☒ 120x120mm F2+H5

☒ 120x120mm T2+H5



 Padded laptop compartment



without decoration

**SILVER RAY** 56-0819571

Backpack "Silver Ray": 2 zipper front pockets: 1 with organizer, spacious zipper main compartment with padded laptop pocket and 1 slip-in pocket, 1 side mesh pocket, 1 side zipper pocket, strong carrying handle, padded shoulder straps and back area

Packing: 15 pieces |

Size: approx. 32x18,5x46,5 cm |

Material: 1680D Polyester

Branding:

☒ 100x20mm T1+H2



 Padded laptop compartment



without decoration



FLOW 56-0219529

Backpack "Flow" main pocket with zip includes a padded pocket for your laptop, many pockets for accessories, Velcro fastener on the front pocket with earphone hole, strong carrying handle, water-resistant bottom, padded shoulder strap and back



Packing: 10 pieces |

Size: approx. 41x31x21 cm |

Material: 600D Polyester

Branding:

150x100mm T2+H2

Padded laptop compartment



MULTI 56-0805335

Reporter bag "Multi", first pocket with 3 slip-in pockets and 2 compartments which can be used for e.g. laptop, second pocket with large organizer and various pockets for pens, business cards, mobile phone pocket and keyholder strap, strong carrying handle with Velcro fastener and an adjustable and removable shoulder strap with a shoulder pad



Packing: 20 pieces |

Size: approx. 40x30x13 cm |

Material: 600D Polyester

Branding:

150x100/200x120mm T2+H2

Padded laptop compartment



DELUXE 56-0819573

Backpack "Deluxe": padded zipper media pocket with earphone hole – suitable for discman and other devices, zipper front pocket with organizer, key holder, and 1 zippered pocket inside, spacious zipper main compartment, side zipper laptop compartment with additional Velcro strap and mobile padding for greater safety, strong carrying handle, shoulder straps and back area comfortably padded



Packing: 10 pieces |

Size: approx. 30x22,5x44 cm |

Material: 1680D/600D Polyester

Branding:

80x120mm F2+H4

80x120mm T2+H4

Padded laptop compartment



MEETING 56-0805336

Reporter bag "Meeting" with a main pocket with a zip and a padded laptop pocket, second main pocket with a large organizer, 1 front pocket with a zip, 1 slip-in pocket on the back with a Velcro fastener and a transparent pocket for a business card and with a zip which serves a reporter function, 2 strong handles, 1 adjustable and detachable shoulder strap with shoulder pad

Packing: 20 pieces | Size: approx. 40x30x13cm | Material: 600D Polyester

Branding:

 100x40mm T2+H2

 Padded laptop compartment



 Bags with reporter function come with a strap or similar holding device on the back of the bag. Thanks to this the bag can be comfortably placed on a trolley frame and can easily be transported - without the bag falling off the trolley.

VIVA 56-0214505

College bag "Viva" with large main pocket and front pocket with zip, earphone/cable hole, built-in organizer, strong carrying handle and an adjustable and removable shoulder strap

Packing: 20 pieces | Size: approx. 40x30x11 cm | Material: 600D Polyester

Branding:

 200x150mm T2+H2

 With reporter function



XXL
print

VIVA 56-0219525

Backpack "Viva" various pockets with zips, earphone hole, carrying handle, clip closures on the sides, padded shoulder strap and back

Packing: 20 pieces | Size: approx. 42x31x17 cm | Material: 600D Polyester

Branding:

 200x40mm T2+H2

 With earphone hole



HIGH-CLASS

Backpack "High-Class": front zip pocket with carabiner on the outside, main zip compartment with slip-in pocket and small interior zip pocket, as well as earphone hole, 2 mesh pockets and compression straps on the side, reinforced carrying handle, shoulder straps and back with comfortable padding



Packing: 15 pieces |

Size: approx. 48x32x18 cm |

Material: 1680D Polyester

Branding:

☛ 120x150mm F2+H3

☛ 120x150mm T2+H3



56-0819568
grey



56-0819569
blue/grey

TWOSOME 56-0819572

Backpack "Twosome" – can also be used as a document bag: front zip pocket, 1 main zip pocket with small organizer, 1 padded main zip compartment with slip-in pocket – suitable for a laptop, 2 silver coloured carrying handles, 2 adjustable padded shoulder straps, zip pocket on the back side to stow shoulder straps



Packing: 15 pieces |

Size: approx. 42,5x28x17 cm |

Material: 1680D Polyester

Branding:

☛ 200x200mm F2+H4

☛ 200x200mm T2+H4



without decoration

☛ 2 carrying options



URBAN

Backpack "Urban": zippered main compartment, zippered front compartment, two side zippered pockets, carrying loop, padded shoulder straps and back



Packing: 20 pieces |

Size: approx. 43x30x20/24 cm |

Material: 600D Polyester

Branding:

☛ 90x100mm T2+H2



without decoration



56-0819533
red/grey



56-0819532
blue/grey



Bonjour Paris!



NEW CLASSIC

Backpack "New Classic" main pocket and 3 front pockets with zip and organizer, includes a pocket for your portable CD player with an earphone hole, mesh pockets on the side, strong carrying handle and padded shoulder straps and back

Packing: 20 pieces |
Size: approx. 42x31x24 cm |
Material: 600D Polyester

Branding:
☞ 100x90mm T2+H2



☞ With earphone hole



56-0219516
black/blue

56-0219517
black/red

CROSS

Weatherproof rucksack "Cross" with a main pocket with a zip, front pocket with a zip, 2 side pockets with zips, pocket with zip and rain cover, strong carrying handle, padded shoulder strap and waist belt with padded and reinforced back

Packing: 10 pieces |
Size: approx. 53x35x18 cm |
Material: 600D Polyester

Branding:
☞ 60x40mm F2+H2
☞ 60x40mm T1+H2

☞ With rain cover



56-0219539
black

56-0219540
blue

FUN

Backpack "Fun": vertical zip front pocket, 1 spacious main zip compartment with 1 pocket inside, bottom area and zip pulls in suede look, carrying handle, padded shoulder strap and back area

Packing: 20 pieces | Size: approx. 29,5x14,5x45 cm |
Material: 600D Polyester

Branding:
☞ 120x170mm F2+H2
☞ 120x170mm T2+H2

🛒 NEW



56-0819600
grey

56-0819601
dark blue

56-0819602
red

56-0819603
light blue



TOP

Rucksack "Top" with 1 pocket on the front with a zip, 1 main pocket with zip, adjustable and padded shoulder strap and a padded back

Packing: 20 pieces |

Size: approx. 40x28x14 cm |

Material: 600D Polyester

Branding:

100x60mm T2+H2



 Padded back



56-0819508
black



56-0819509
blue



56-0819510
red



56-0819515
yellow



56-0819594
apple green

CHAP

Backpack "Chap" with front zip pocket, zippered main compartment, adjustable and padded shoulder straps, and 1 carrying handle

Packing: 50 pieces |

Size: approx. 30x10,5x39,5cm |

Material: 600D Polyester

Branding:

100x60mm T2+H2



56-0819561
pink



56-0819562
light blue



56-0819563
grey



56-0819556
black



56-0819557
blue



56-0819558
red



56-0819559
dark green

56-0819560
apple green



56-0819564
orange



56-0819565
yellow



56-0819566
white



POP

Backpack "Pop": vertically zipper front pocket, zipper main compartment, 1 side mesh pocket, carrying handle, padded shoulder straps and back area

Packing: 40 pieces | Size: approx. 28,5x15x39,5 cm | Material: 600D Polyester

Branding:

☛ 130x200mm F2+H2

☛ 130x200mm T2+H2

☛ 80x80mm T1+H2

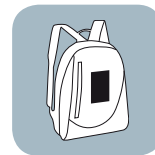

56-0819580
grey/black



56-0819581
grey/blue



56-0819582
grey/red



56-0819583
grey/apple green



56-0819584
grey/orange



56-0819585
grey/white

STREAM

Backpack "Stream": zippered main compartment, zippered pocket with extra organizer compartment, 2 lateral mesh pockets, lateral compression straps, carrying handle, padded shoulder straps and back

Packing: 20 pieces | Size: approx. 42x29x13cm | Material: 600D Polyester

Branding:

☛ 80x40 m T1+H2



56-0819534
black/grey



56-0819535
grey/light grey



BIKE 56-0230500

3 piece travel set "Bike", consists of a pair of pannier bags plus backpack, both bags with zip front pocket and reflector stripe, includes raincover for the set and an adjustable and detachable shoulder strap for the bike bag

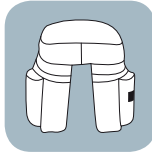

Packing: 10 pieces |

Size:

- 1 approx. 28x41 x12 cm
- 2 approx. 31x41 x 12,5 cm |

Material: 600D Polyester

Branding:

80x80mm T1+H3

 Weatherproof

**BIKE** 56-0230501

Cooler bag "Bike" for the handlebar, zip main compartment for cooling, extra zip front pocket plus transparent pocket for a road map, includes raincover and an adjustable shoulder strap



Packing: 10 pieces |

Size: approx. 30x15x18 cm |

Material: 600D Polyester

Branding:

80x40mm T1+H2



 Weatherproof

**DYNAMIC** 56-0230300

Bicycle bag "Dynamic" with heavy duty material, divided in 2 bags with zip pocket, flap with Velcro, each bag with strap on the inside, carrying handle on the top and reflectors for traffic

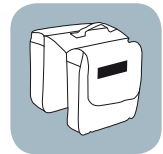

Packing: 10 pieces |

Size: approx. 87,5x32,5x9,5/36x32,5x9,5 cm |

Material: Chlorofibre

Branding:

220x 100mm T2+H4



CURVE

Backpack "Curve": zippered main compartment, zippered front compartment, carrying loop, padded shoulder straps and back

Packing: 20 pieces |

Size: approx. 46x34x19 cm |

Material: 600D Polyester

Branding:

125x100mm T2+H3



56-0819530
red/black



56-0819529
blue/black



56-0819531
light green/black



STYLE

Shopper bag "Style" with a large zippered compartment, 2 long handles, and plastic loop for hanging e.g. keys, or a shopping cart chip

Packing: 40 pieces | Size: approx. 38x38 cm |

Material: 600D Polyester

Branding:

100x100mm T2+H2



56-0820547
purple/black



56-0820548
grey/black



56-0820549
red/black



56-0820550
light blue/black



56-0820551
light green/black



TEC

Backpack "Tec": front zip pocket with earphone hole, main zip compartment, carrying strap, 2 mesh pockets on the side, padded shoulder straps

Packing: 50 pieces | Size: approx. 28,5x17x40 cm |

Material: 600D Polyester

Branding:

130x200mm F2+H2

130x200mm T2+H2

80x80mm T1+H2



56-0819575
dark blue



56-0819576
red



56-0819577
royal blue



56-0819578
light green



56-0819579
orange



56-0819574
black

 With earphone hole



ACTION

Shoulder bag "Action" with heavy-duty material, front pocket includes a padded laptop pocket with organizer and an adjustable shoulder strap with shoulder pad

Packing: 10 pieces | Size: approx. 34,5x31,5x13,5 cm | Material: Chlorofibre

Branding:

 150x250mm T2+H2



CLEVER

Shoulder bag "Clever" with heavy-duty material, flap with a Velcro fastener, 1 main pocket, 1 inner slip-in pocket and an adjustable shoulder strap

Packing: 30 pieces | Size: approx. 33x30x9 cm | Material: Chlorofibre

Branding:

 150x200mm T2+H2

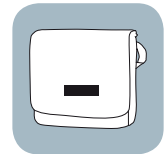

CITY

Shoulder bag "City" in a sporty stripe design: flap with Velcro fastener, spacious main compartment, 2 side mesh pockets, adjustable shoulder strap

Packing: 40 pieces | Size: approx. 39x28x11 cm | Material: 600D Polyester

Branding:

☰ 140x60mm T2+H2

☰ 60x30mm T1+H2



56-0814544
blue/black



56-0814543
grey/black



56-0814545
red/black



56-0814546
green/black



56-0814547
lilac/black



56-0814548
light blue/black



56-0814549
pink/black



56-0814550
orange/black

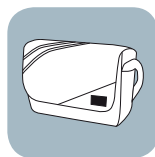

VISUAL

Shoulder bag "Visual" with a transparent PVC slip-in pocket on the front - perfect for advertising, flap with Velcro, large main pocket, adjustable strap and a reporter function on the back

Packing: 50 pieces |

Size: approx. 37x30x13 cm |

Material: 600D Polyester

Branding:

☰ 80x25mm T1+H2



without decoration

56-0814536
red



56-0814535
black



56-0814537
orange



56-0814538
light blue

☰ With reporter function

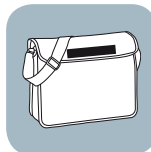

BUSY

Document bag "Busy": vertically zipper front pocket, slip-in pocket on the front, zipper main compartment, strong carrying handle, adjustable and removable shoulder strap

Packing: 50 pieces |

Size: approx. 38x9x28,5 cm |

Material: 600D Polyester

Branding:

☛ 200x100mm F2+H2

☛ 200x100mm T2+H2



56-0814552
grey



56-0814553
blue



56-0814554
red



56-0814555
beige



FILE

Document bag "File" with a zip on the front pocket, 1 main pocket with zip, 1 strong carrying handle

Packing: 25/100 pieces |

Size: approx. 38,5x28,5x3 cm |

Material: 600D Polyester

Branding:

☛ 150x100/100x50mm T2+H2



56-0814515
black/orange



56-0814510
black



56-0814511
black/blue



56-0814512
black/purple



56-0814513
black/green



56-0814514
black/red



56-0814516
black/light green



56-0814517
black/yellow

PI

Elegant document bag "Pi" with zip on the main and front pocket, mobile phone pocket with an adjustable and detachable shoulder strap

Packing: 40 pieces | Size: approx. 38x28x9,5 cm |

Material: 600D Polyester

Branding:

☛ 120x100mm T2+H2



56-0805241
black/red



56-0805242
black/orange



56-0805240
black/royal blue



56-0805243
black/light blue



56-0805244
black/grey



BRISTOL

Document bag "Bristol": Velcro front pocket with coloured cover, spacious main zip compartment, 2 reinforced and differently coloured carrying handles, adjustable shoulder strap

Packing: 40 pieces | **Size:** approx. 39x29x7,5 cm | **Material:** 300D Polyester

Branding:

- ☛ 150x50/300x100mm F2+H2
- ☛ 150x50/300x100mm T2+H2



56-0814563
black/dark green

56-0814564
black/red

56-0814562
black/blue

56-0814565
black/grey

56-0814566
black/turquoise

56-0814567
black/orange

SMART

Shoulder bag "Smart": cover with Velcro, spacious main compartment with small organizer for pens, wide shoulder strap

Packing: 100 pieces | **Size:** approx. 36x8x30cm | **Material:** Polypropylene

Branding:

- ☛ 250x200mm F2+H2
 - ☛ 250x200mm T2+H2
- non-woven

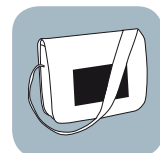

56-0814570
black

56-0814571
blue

56-0814572
red

56-0814573
light blue

56-0814574
pink

56-0814576
light green

56-0814577
white

56-0814575
yellow

BELLY

Belt pouch "Belly": spacious zip main pocket – with small pocket on the inside, adjustable belt with buckle – ideal for valuables and small items



Packing: 100/200 pieces |

Size: approx. 35,5x5,5x15 cm | Material: 600D Polyester

Branding:

150x50mm F2+H2

150x50mm T2+H2



56-0890022
blue



56-0890020
black



56-0890021
grey



56-0890023
red



56-0890024
pink



56-0890025
light green



56-0890026
orange



GYM

Sports bag "Gym" with main zip compartment, front pocket with Velcro, 2 side zip pockets, one for shoes, strong handle, adjustable and removeable shoulder strap with padding

Packing: 20 pieces | Size: approx. 48x30x27 cm |
Material: 600D Polyester

Branding:

100x90mm T2+H2

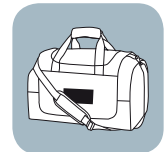

56-0808528
grey/light blue



With shoe compartment



56-0808526
grey/black



56-0808527
grey/dark blue



56-0808529
grey/light green



56-0808530
grey/pink

ICELAND 56-0208559

Travel bag "Iceland" main pocket and front pocket with zip, 2 rounded side pockets with zip, includes an adjustable and removable shoulder strap with shoulder pad



Packing: 20 pieces |

Size: approx. 60x33x29 cm |

Material: 600D Polyester

Branding:

160x80mm T2+H2

**WORKOUT**

Sports bag "Workout": spacious main zip compartment, 2 carrying handles, adjustable shoulder strap



Packing: 50 pieces | Size: approx. Ø28x55 cm |

Material: 600D Polyester

Branding:

160x250mm F2+H2

160x250mm T2+H2



56-0808545
turquoise



56-0808540
black



56-0808541
blue



56-0808542
red



56-0808543
grey



56-0808544
orange



56-0808546
light green



56-0808547
white

CHAMP

Sports bag "Champ" with a zip on the main pocket, white front pocket with zip, side pockets with zip, strong carrying handle and an adjustable and removable shoulder strap with shoulder pad



Packing: 20 pieces |

Size: approx. 66x36x29 cm |

Material: 600D Polyester

Branding:

150x60mm T2+H2



56-0805340
black/white



56-0805341
dark blue/white



56-0805344
orange/white



56-0805342
royal blue/white



56-0805343
red/white



56-0805345
yellow/white



56-0805346
green/white



SPORTIVE 56-0808551

Sports bag "Sportive": zip front pocket with grey trimming, spacious zip main compartment, zip pocket on the back, 2 side slip-in pockets, reinforced carrying handles, adjustable and removable shoulder strap

Packing: 15 pieces | Size: approx. 50x25x30cm | Material: Polyester

Branding:

 110x80/300x150mm F2+H2

 110x80/300x150mm T2+H2



PEP

Sport bag "Pep" with a zip front pocket, main zip pocket, strong carrying handle and an adjustable shoulder strap

Packing: 20 pieces | Size: approx. 55x32,5x28cm | Material: 600D Polyester

Branding:

 150x50mm T2+H2



56-0808518
black/green



56-0808515
black/grey



56-0808516
black/blue



56-0808517
black/red



56-0808519
black/purple



56-0808520
black/yellow



56-0808521
black/orange

FITNESS

Sports bag "Fitness": spacious zip main compartment, 2 mesh pockets at the side, 2 carrying handles, adjustable shoulder strap

Packing: 25 pieces | Size: approx. 45x19x26cm | Material: 600D Polyester

Branding:

 300x100mm F2+H2

 300x100mm T2+H2



56-0808554
black/red



56-0808552
black/grey



56-0808553
black/blue



56-0808555
black/pink



56-0808556
black/turquoise



56-0808557
black/light green

JORDAN

Sports bag "Jordan": with zippered main compartment, front zip pocket, reinforced carrying handles, adjustable shoulder strap, and reinforced bottom

Packing: 20 pieces | Size: approx. 48x22x28cm |
Material: 600D Polyester

Branding:

 160x80mm T2+H2



56-0808536
black/light blue

56-0808531
black/grey



56-0808532
black/blue



56-0808533
black/red



56-0808534
black/green



56-0808535
black/purple



56-0808537
black/pink



56-0808538
black/orange



DOME

Sportsbag "Dome" with large shoe section, main section and 2 side pockets with zip, slip-in pocket on the back side, water-resistant bottom, includes an adjustable and removable shoulder strap with a shoulder pad

Packing: 15 pieces | Size: approx. 60x36x26cm |
Material: 600D Polyester

Branding:

 150x80/100x80mm T2+H2



56-0208561
black/blue



56-0208563
black/red

 With shoe compartment



56-0208562
black/grey

without decoration



MARINA 56-0210530

Toilet bag "Marina" with 2 parallel zips on the top with an additional Velcro fastener, 6 slip-in pockets on the inside and a decorative loop on the outside

Packing: 50 pieces |

Size: approx. 27x16x14,5cm |

Material: 600D/300D Polyester

Branding:

☞ 80x25/80x40mm T1+H2

**MARINA** 56-0220518

Beach bag "Marina" with a zip on the front pocket, main compartment and inner pocket with 2 strong long carrying handles

Packing: 20 pieces |

Size: approx. 47x35x13cm |

Material: 600D/300D Polyester

Branding:

☞ 70x70mm T1+H2

**MARINA** 56-0290510

Cooler bag "Marina", in maritime colours: insulated zip main compartment, 2 main compartment, 2 carrying handles

Packing: 20 pieces | Size: approx. 25x25x28cm |

Material: 600D/300D Polyester

Branding:

☞ 180x170mm F2+H2

☞ 180x170mm T2+H2

☞ 60x60mm T1+H2



MARINA 56-0208513

Sports bag "Marina": zippered main compartment, two lateral zippered pockets, reinforced carrying handles, adjustable and removable shoulder strap

Packing: 15 pieces |

Size: approx. 64x27x26 cm |

Material: 600D Polyester

Branding:

 130x45 / 100x100mm T2+H3

**MARINA** 56-0219528

Matchesack "Marina" with draw string on the main pocket, zip on the front pocket, strong carrying handles with an adjustable shoulder strap

Packing: 20 pieces | Size: approx. Ø30x50 cm |

Material: 600D/300D Polyester

Branding:

 90x100mm T2+H2

**MARINA** 56-0219546

Backpack "Marina": zippered main compartment, zippered front pocket with extra zippered pocket, 2 lateral mesh pockets, lateral compression straps, reinforced carrying handle, padded shoulder straps and back

Packing: 20 pieces |

Size: approx. 44x32x18 cm |

Material: 600D Polyester

Branding:

 100x100mm T2+H3



MARLENE 56-0820545

Beach bag "Marlene": zippered main compartment, extra inner zip pocket, pocket on the front, striped shoulder straps with decorative metal eye, stain-resistant bottom



Packing: 30 pieces |
Size: approx. 49x34,5x9,5cm |
Material: 300D Polyester

Branding:
☰ 85x85mm T2+H2



 water-repellent bottom

EASY

Shopper "Easy" with a zip on the main pocket, small inside pocket with zip and strong bottom



Packing: 40 pieces |
Size: approx. 56x15x36cm |
Material: 600D Polyester

Branding:
☰ 300x200mm T2+H2



BLOWBALL

Shopper "Blowball" with a zip on the main pocket, slip-in side pockets, inside pocket with mobile phone pocket, zip pocket on the back, strong carrying handles and bottom



Packing: 20 pieces | Size: approx. 42x21x33cm |
Material: 600D Polyester

Branding:
☰ 170x120mm T2+H2



56-0820540
blue



56-0820541
orange



56-0820542
light green



56-0820543
purple

56-0820544
pink





CAPRI

Beach bag "Capri": closable with Velcro, nice cotton handles with metal eyelet

Packing: 30 pieces |
Size: approx. 45x18x35 cm |
Material: 300D Polyester

Branding:

 300x230 mm F2+H2
 300x230 mm T2+H2



56-0820555
light green



56-0820552
blue



56-0820553
lilac



56-0820554
pink



56-0820556
orange



56-0820557
yellow

SYLT

Beach bag "Sylt" – in maritime-coloured stripes: spacious main compartment with Velcro closure, additional zip pocket inside for valuables or other, 2 cord carrying handles made of cotton with metal eyelet

Packing: 30 pieces | Size: approx. 47x17x34 cm |
Material: 300D Polyester

Branding:

 300x50 mm F2+H2
 300x50 mm T2+H2



56-0820561
blue/white



56-0820560
black/white



56-0820562
green/white



56-0820563
red/white

LIFE

Shopper "Life" with a zip main pocket and extra zip pocket inside

Packing: 30 pieces |
Size: approx. 46x36x16,5 cm |
Material: 600D Polyester

Branding:

 130x130 mm T2+H2



56-0820522
pink

without decoration



56-0820521
green



56-0820520
blue



RIMINI

Matchesack "Rimini" with spacious main pocket, drawstring and adjustable shoulder strap

Packing: 20 pieces | **Size:** approx. Ø30x50cm | **Material:** 600D Polyester

Branding:
 100x100mm T2+H2



56-0819550
black



56-0819551
dark blue



56-0819552
light blue



56-0819553
light green



56-0819554
pink



TOWN

Backpack "Town" with 2 carrying handles, also useable as a shoulder bag

Packing: 100/200 pieces | **Size:** approx. 30x42cm | **Material:** 210D Polyester

Branding:
 220x230mm T2

XXL
print



56-0819536
black



56-0819537
blue



56-0819538
red



56-0819540
light green



56-0819541
light blue



56-0819539
pink



56-0819542
yellow



56-0819543
white

DOWNTOWN

Drawstring backpack "Downtown": with 2 carrying strings, can be carried over the shoulder or as backpack

Packing: 100/200 pieces | **Size:** approx. 30x42 cm | **Material:** Polypropylene

Branding:
 80x100mm F2+H2
 80x110mm T2+H2
 non-woven



56-0819589
pink



56-0819586
black



56-0819587
blue



56-0819588
red



56-0819590
light green



56-0819591
light blue



56-0819592
yellow



56-0819593
white

EASYCOOL

Carrying cooler bag "Easycool" for 0,5 litre bottle with Velcro fastener and drink opening with an adjustable shoulder strap

Packing: 50/200 pieces | Size: approx. 20x7 cm |
Material: 420D Nylon

Branding:

☐ 50x80mm T1+H2



56-0802015
blue

56-0802020
light blue

56-0802021
rose

56-0802016
red

56-0802017
white

56-0802018
green

56-0802019
orange

56-0802022
yellow

MERLOT

Bottle bag "Merlot": with 2 cord carrying handles, see-through panel, suitable for a bottle – ideal for wine and sparkling wine bottles

Packing: 400 pieces |
Size: approx. 8,5x8,5x36cm |
Material: Polypropylene

Branding:

☐ 60x80mm F2+H2

☐ 60x80mm T1+H2
non-woven



56-0820801
blue



56-0820800
bordeaux

CABERNET

Felt bottle bag "Cabernet" with 2 handles, suitable for 1 litre bottle

Packing: 100 pieces |
Size: approx. 29,5x10,5x10,5cm |
Material: Polyester

Branding:

☐ 40x40mm T1+H2



56-0820711
grey



56-0820710
red



STAR DUST 56-0820707

Felt shopper "Star Dust": with Velcro fastener and 2 long shoulder straps, nice star on the front

Packing: 40 pieces |

Size: approx. 30x8,5x41 cm |

Material: Polyester

Branding:

☛ 300x50/300x250mm F2+H2

☛ 300x50/300x250mm T2+H2



STAR DUST 56-0820708

Felt organizer "Star Dust": with zip pocket – multi-purpose useable, e.g. for pens, accessories or cosmetic items – with nice star on the front

Packing: 120 pieces | Size: approx. 25x17 cm |

Material: Polyester

Branding:

☛ 210x110mm F2+H2

☛ 60x25mm F1+H2

☛ 210x110mm T2+H2

☛ 60x25mm T1+H2

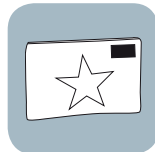

TOMSK

Felt shopper "Tomsk" with long handles and Velcro

Packing: 40 pieces |

Size: approx. 38x42x8 cm | Material: Polyester

Branding:

☛ 200x200mm F2+H2

☛ 200x200mm T2+H2



56-0820703
anthracite

56-0820704
blue

56-0820705
green

56-0820706
pink

HOMY 56-0820716

Felt firewood bag "Homy": with 2 sturdy carrying straps – ideal for transportation and storage of firewood, also suitable for storage of newspapers, wool, etc.

Packing: 20 pieces |

Size: approx. 50x25x25 cm | Material: Polyester

Branding:

☛ 300x100mm F2+H2

☛ 300x100mm T2+H2

**COSY** 56-0820715

Felt firewood bag "Cosy": with wide carrying strap – ideal for transportation and storage of firewood, also suitable for storage of newspapers, wool, etc., dimensioned for max. 15 kg

Packing: 20 pieces |

Size: approx. 36x40x40cm | Material: Polyester

Branding:

☛ 200x150mm F2+H2

☛ 200x150mm T2+H2



SHOPPY

Shopping bag "Shuppy" with long handles and plastic eye to hang up the colour-matching bag with Velcro closing

Packing: 100/300 pieces | Size: approx. 38x42cm | Material: 190T Polyester

Branding:

-  100x60mm T1+H7
-  50x30mm T1+H6
-  100x60mm S3+H7
-  50x30mm S3+H6



56-0820500
black

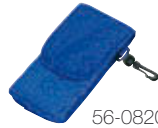

56-0820501
blue



56-0820502
red



56-0820504
pink



56-0820505
orange



56-0820506
yellow

56-0820503
turquoise



without decoration



56-0820507
beige

PORTO

Shopping bag "Porto", foldable: with 2 handles, can be folded to save space, with press button fastener

Packing: 150 pieces | Size: approx. 20x12x2/40x47,5cm | Material: Polypropylene

Branding:

-  160x30mm F2+H2
 -  160x30mm T2+H2
- non-woven

 Can be folded to save space



56-0808061
black



56-0808062
blue



56-0808063
red



56-0808064
light blue

without decoration



56-0808065
light green





56-0808066
yellow

PALMA

Shopping bag "Palma" foldable with press stud, handle fastening strengthened by metal eyelets, reinforced bottom for improved stability

Packing: 25/100 pieces |
Size: approx. 21,5x20,5x2/40x34x20cm |
Material: Polypropylene

Branding:

-  280x280/100x80mm T2+H4
 -  280x280/100x80mm S9+H4
- non-woven



56-0808056
red



56-0808057
lilac



56-0808055
blue



56-0808058
green



56-0808059
orange



56-0808060
white



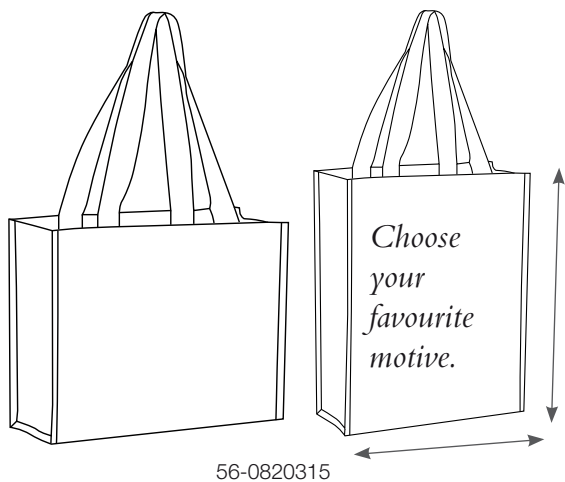

AT LAST, DESIGNER BAGS!

Design your individual bag as your customer needs.

We offer you the Know-How so you can decide.

Choose the colour.

Choose the size.

Choose your favourite photo.

The result:

So unique that everyone will want to have one.

Material: Polypropylene

Minimum order quantity:
depending on the size of the bag
(5.000 to 10.000 pieces)



MARKET

Shopping bag "Market" with long carrying straps

Packing: 300 pieces | Size: 45x37 cm | Material: Polypropylene

Branding:

☞ 280x280mm T2

☞ 280x280mm S9

non-woven

XXL
print



56-0808030
blue



56-0808031
black



56-0808032
white



56-0808025
red



56-0808026
light blue



56-0808027
pink



56-0808028
yellow



56-0808029
light green

MALL

Shopper "Mall" with long and wide shoulder straps

Packing: 200 pieces | Size: approx. 36x30x9cm |

Material: Polypropylene

Branding:

☞ 220x220mm T2

non-woven

XXL
print



56-0808034
black



56-0808035
blue



56-0808036
red



56-0808037
yellow



56-0808038
white

JAMIE 56-0808023

Apron "Jamie" with a front pocket

Packing: 300 pieces |

Size: 80x49cm | Material: Cotton

Branding:

☰ 145x120/280x170mm T2+H2

⬇ 145x120/280x170mm S9+H2

**SAILOR** 56-0808020

Matchesack "Sailor" with draw string, can be used as rucksack or shoulder bag

Packing: 200 pieces |

Size: approx. 45xØ25 cm |

Material: Cotton

Branding:

☰ 250x250mm T2+H2

⬇ 250x250mm S9+H2

Twill

**XXL**
print**PURE**

Cotton bag "Pure" with short handles

Packing: 300 pieces | Size: 38x42cm |

Material: Cotton

Branding:

⬇ 290x290mm S9

56-0808011
blue**XXL**
print56-0808012
red56-0808016
white56-0808019
black

SUBURB 56-0819596

Drawstring bag "Suburb": with 2 carrying strings, can be carried over the shoulder or as backpack

Packing: 100/200 pieces |

Size: approx. 37x41 cm |

Material: Cotton

Branding:

☛ 300x350mm F2+H2

☛ 300x350mm T2+H2

☛ 300x350mm S9+H2



XXL
print

PURE 56-0808001

Cotton bag "Pure" with short handles

Packing: 300 pieces | Size: 38x42 cm |

Material: Cotton

Branding:

☛ 290x290mm S9



XXL
print

**PURE** 56-0808003

Cotton bag "Pure" with long handles

Packing: 300 pieces | Size: 38x42 cm |

Material: Cotton

Branding:

☛ 290x290mm S9

Long handles



XXL
print

**LITTLE** 56-0808005

Small cotton bag "Little" with short handles

Packing: 1000 pieces | Size: 23x26 cm |

Material: Cotton

Branding:

☛ 180x200mm S9



DEGREE

Cooler bag "Degree", shaped like a shopping bag; insulated zip main compartment, 2 carrying handles

Packing: 40 pieces | Size: approx. 35,5x25x38 cm | Material: Polypropylene

Branding:

👉 140x200mm F2+H2

👉 140x200mm T2+H2



non-woven



56-0801153
blue



56-0801154
red



56-0801155
light blue



56-0801156
light green



56-0801157
yellow



56-0801158
white



DOTTY

Cooler bag "Dotty": with insulated main zip compartment, 1 slip-in pocket on the front and 2 carrying handles

Packing: 20 pieces | Size: approx. 34x13x34 cm | Material: 600D Polyester

Branding:

👉 200x120mm F2+H2

👉 200x120mm T2+H2



56-0801150
black



56-0801151
red



56-0801152
blue



CELSIUS

Cooler bag "Celsius": with insulated zip pocket and carrying handle

Packing: 50 pieces |

Size: approx. 20,5x13,5x17 cm |

Material: Polypropylene

Branding:

☰ 120x80mm T2+H2



non-woven



56-0801130
blue



56-0801131
red



56-0801132
pink



56-0801133
light blue



56-0801135
yellow



56-0801134
light green



56-0801136
white

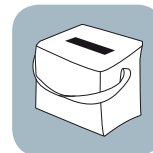

ICE

Cooler bag "Ice" in square format: with insulated zippered main compartment, a zippered pocket on the front, adjustable shoulder strap

Packing: 25 pieces |

Size: approx. 28,5x25x25/30 cm |

Material: 420D Polyester

Branding:

☰ 120x80mm T2+H2



56-0801124
silver grey



56-0801125
turquoise



GLACIAL

Cooler bag "Glacial": with insulated main zip compartment, 1 slip-in front pocket, 1 side mesh pocket and adjustable shoulder strap

Packing: 25 pieces |

Size: approx. 23x16x26 cm |

Material: 420D Polyester

Branding:

☰ 110x80mm T2+H2



56-0801140
blue



56-0801141
red



56-0801142
pink



56-0801143
orange



56-0801146
yellow



56-0801144
light blue



56-0801145
light green



SERVICE & QUALITY

OFFICE & BUSINESS

MUSIC & TIME

LIGHTS & TOOLS

SAVE & PRACTICAL



SUN & RAIN

➤ *„I make the right choice
no matter the weather.“*

The weather – it's just like shopping. Whenever I can't decide, I take some of everything. My umbrellas are fit for rain, weather-beaten, or provide shade. They keep me in a good mode in all weather conditions.

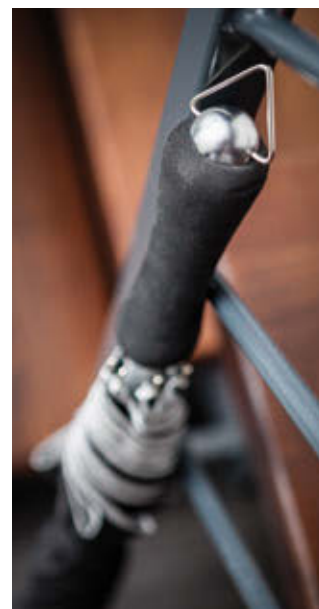

POCKET

Aluminium mini pocket umbrella "Pocket" with EVA pouch: 164g light weight framework, 5 section aluminium shaft with aluminium ribs, fibreglass ends and metal tips, colour-matching rubber-coated handle with a polyester pongee canopy

Packing: 12/48 pieces | Size: Ø85 cm | Material: 164g Aluminium/Fibreglass/Polyester

Branding:

☞ 60x40mm T1+H6

☞ 230/170x140/100x30mm T2+H6

☞ 230/170x140/60x40mm S1+H6



56-0101055
navy blue



56-0101056
black



 Packed in a pouch

REGULAR

Pocket umbrella "Regular" with manual opener, 2 section metal shaft and metal ribs, black plastic handle with a polyester canopy, closure with Velcro

Packing: 12/60 pieces | Size: Ø85 cm | Material: Metal/Polyester

Branding:

☞ Ø25mm D1

☞ 230/170x140/100x50mm T2+H6

☞ 230/170x140/100x50mm S1+H6



56-0101104
orange



56-0101111
red/white



56-0101112
blue/white



56-0101113
green/white



56-0101115
green/blue/
red/yellow



56-0101101
green



56-0101102
black



56-0101106
yellow



56-0101108
blue



56-0101109
red



56-0101110
white



56-0101116
light blue



56-0101120
navy blue

FLAT

Super slim mini pocket umbrella "Flat", 164g light weight framework, 3 section aluminium shaft, with aluminium ribs, fibreglass ends and metal tips, silver-coloured handle with polyester pongee canopy

Packing: 12/60 pieces | Size: Ø88 cm | Material: 164g Aluminium/Fibreglass/Polyester

Branding:

☞ 25x10mm K1+H2+V1

☞ 230/170x140/150x50mm T2+H6

☞ 230/170x140/150x50mm S1+H6



☞ Extra flat + ultra light



56-0101145
brown

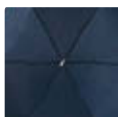

56-0101140
navy blue

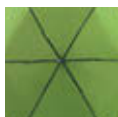

56-0101141
light green



56-0101142
light blue

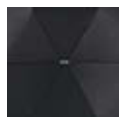

56-0101143
black

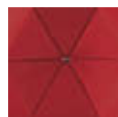

56-0101144
dark red



SHORTY

Aluminium pocket umbrella "Shorty" with colour-matching PVC zip pouch shaped as a can (Ø 17x7 cm) and carabiner hook, 215g light weight frame, 5 piece aluminium shaft, with aluminium/fibreglass ribs and metal tips, plastic handle, polyester pongee canopy and a closure with Velcro

Packing: 12/48 pieces | Size: Ø 88 cm | Material: Aluminium/Fibreglass/Polyester

Branding:

☞ 230/170x140mm T2+H6

☞ 60x20mm T1+H6

☞ 230/170x140/60x20mm S1+H6

☞ 30x10mm L4+H4



56-0101171
dark green

CREADO



☞ Improved
PVC-Can



56-0101170
blue



56-0101172
white



56-0101173
black



56-0101174
red



MISTER

Automatic windproof pocket umbrella for men "Mister" with a 2 piece metal shaft, ribs, tips, plastic handle and a polyester pongee canopy, closure with Velcro

Packing: 12/36 pieces | Size: Ø 95 cm | Material: Metal/Polyester

Branding:

☞ Ø30mm D1

☞ 15x15mm K1+H2

☞ 230/170x140/100x50mm T2+H6

☞ 230/170x140/100x50mm S1+H6

auto  54,5



56-0101150
navy blue



56-0101151
black



I am the umbrella queen! ☀️ ☂️ ❤️

COVER

Automatic pocket umbrella "Cover" with a 3 piece metal shaft, ribs and tips, rubber-coated grooved handle and a polyester pongee canopy with pouch, closure with Velcro

Packing: 12/60 pieces | Size: Ø96 cm | Material: Metal/Polyester

Branding:

☞ 230/170x140mm T2+H6

☞ 230/170x140mm S1+H6

auto  53



56-0101162
salmon



56-0101160
dark blue

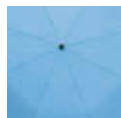

56-0101161
sky blue

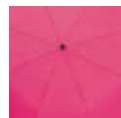

56-0101163
pink

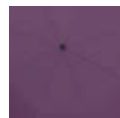

56-0101164
lavender

CREADO



BORA

Automatic open/close, windproof pocket umbrella
 "Bora", 3 section metal shaft, aluminium-plastic-fibreglass ribs, metal tips, rubber-coated handle, polyester pongee canopy with special water-resistant coating, closure with Velcro



Packing: 12/48 pieces | Size: Ø97 cm |
 Material: Metal/Aluminium/Polyester

Branding:

 230/170x140mm T2+H6

 50x10mm T1+H6

 230/170x140mm S1+H6

auto 





56-0101184
blue



 Automatic open / close mechanism

 Pearl effect

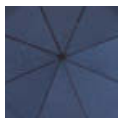

56-0101180
navy blue

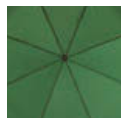

56-0101181
dark green



56-0101182
white

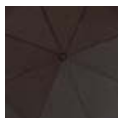

56-0101183
black



56-0101185
yellow



56-0101186
red





PRIMA

Automatic pocket umbrella "Prima", in colour-themed sheath: 3 piece metal shaft, ribs and tips, black plastic knob with colour-themed automatic release button and supporting loop, polyester canopy and closure with Velcro

Packing: 12/48 pieces | Size: Ø96 cm | Material: Metal/Polyester

Branding:

-  15x15mm K1+H2+V1
-  230/170x140/100x50mm T2+H6
-  230/170x140/100x50mm S1+H6



56-0101215
yellow





MINI

Aluminium pocket umbrella "Mini", 172g light weight framework, 3 section aluminium shaft with aluminium ribs, fibreglass ends and metal tips, silver-coloured handle with a 190T polyester canopy

Packing: 12/60 pieces | Size: Ø98 cm | Material: 172g Aluminium/Fibreglass/190T Polyester

Branding:

-  15x15mm K1+H2
-  230/170x140/100x50mm T2+H6
-  230/170x140/100x50mm S1+H6



56-0101077
black

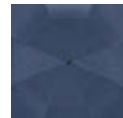

56-0101075
navy blue

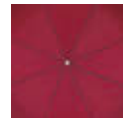

56-0101076
bordeaux



*I'm not afraid
of water!*



EXPRESS

Automatic open/close pocket umbrella "Express", 3 section metal frame with metal ribs, fibreglass ends and metal tips, silver/black plastic handle and polyester pongee canopy

Packing: 12/48 pieces | Size: Ø 100 cm | Material: Metal/Fibreglass/Polyester

Branding:

☰ Ø 20 mm D1

☰ 15x15 mm K1+H2

☰ 230/170x140/100x50 mm T2+H6

☰ 230/170x140/100x50 mm S1+H6

☰ 15x15 mm L4+H2

auto  54,5

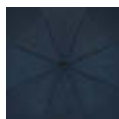

56-0101130
navy blue



56-0101131
dark green



56-0101133
black



56-0101134
grey



56-0101132
bordeaux

CREADO



 Automatic open / close mechanism



LORD

Automatic pocket umbrella for men "Lord" with a 3 piece metal shaft, with metal/fibreglass ribs and metal tips, wooden crook handle, polyester pongee canopy with special water-resistant coating, closure with Velcro

Packing: 12/36 pieces | Size: Ø 101 cm | Material: Metal/Fibreglass/Polyester

Branding:

☰ 230/170x140 mm T2+H6

☰ 230/170x140 mm S1+H6

auto  57

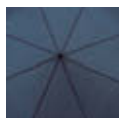

56-0101190
navy blue

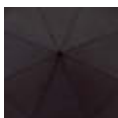

56-0101191
black



56-0101192
dark brown

 Pearl effect

CREADO



TWIST

Pocket umbrella "Twist" with a carrying loop integrated in the handle, 204g light weight frame, 3 piece aluminium shaft, aluminium - fibreglass ribs, metal tips, rubber-coated handle, polyester pongee canopy and pouch, closure with Velcro

Packing: 12/36 pieces | **Size:** Ø98 cm | **Material:** Aluminium/Fibreglass/Polyester

Branding:

☞ 230/170x140/100x50mm T1+H6

☛ 230/170x140/100x50mm S1+H6



56-0101209
light green

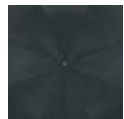

56-0101206
black

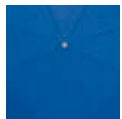

56-0101200
royal blue



56-0101201
turquoise



56-0101202
red



56-0101203
yellow



56-0101204
orange

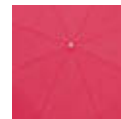

56-0101205
coral



56-0101208
dark green

RING

Stick umbrella "Ring" with an integrated shoulder strap, aluminium shaft, fibreglass ribs, metal tips, rubber-coated handle, polyester pongee canopy and pouch, closure with Velcro

Packing: 12/36 pieces | **Size:** Ø101 cm | **Material:** Aluminium/Fibreglass/Polyester

Branding:

☞ 260/170x150/100x50mm T1+H6

☛ 260/170x150/100x50mm S1+H6



56-0103312
light red

Hidden shoulder strap



56-0103310
navy blue

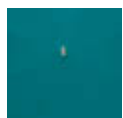

56-0103311
petrol

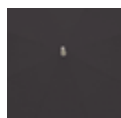

56-0103313
black

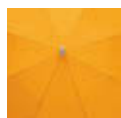

56-0103314
apricot

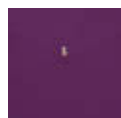

56-0103315
violet



SECRET

Automatic stick umbrella "Secret" with an unscrewable bottom on the handle to store the pouch, aluminium shaft, fibreglass ribs, metal tips, rubber-coated handle, polyester pongee canopy and pouch, closure with Velcro

Packing: 12/36 pieces | **Size:** Ø101 cm |
Material: Aluminium/Fibreglass/Polyester

Branding:

☞ Ø25 mm D1

☞ 260/170x150/100x50 mm T1+H6

☞ 260/170x150/100x50 mm S1+H6

auto 



56-0103304
light brown

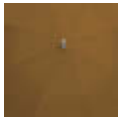

56-0103302
brown

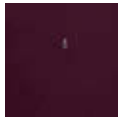

56-0103303
plum



56-0103305
light beige



The difference is in CREATIVITY



Jean Pierre Vitrac



Jeremy Morgan

MAGIC

Automatic golf umbrella "Magic" with an unscrewable bottom on the handle to store the pouch, aluminium shaft, fibreglass ribs, metal tips, rubber-coated handle, polyester pongee canopy and pouch, closure with Velcro

Packing: 12/24 pieces | **Size:** Ø119 cm |
Material: Aluminium/Fibreglass/Polyester

Branding:

☞ Ø25 mm D1

☞ 350/170x240/100x50 mm T1+H6

☞ 300/170x200/100x50 mm S1+H6

auto 



56-0104203
plum

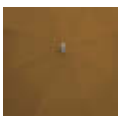

56-0104202
brown

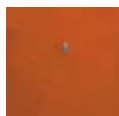

56-0104204
light brown



registered design

Registered Design collection stands for unique, exclusive umbrellas. Created by two world-renowned designers – Jean Pierre Vitrac and Jeremy Morgan – they strike as not only aesthetic and attractive, but also with very distinctive features. By designing models of this assortment we pay our highest attention to the analysis of usability and functionality. As a result, innovative and surprising solutions are created, which turn the ordinary umbrellas into your favourite rain protection.

SAMBA

Automatic stick umbrella "Samba", with metal shaft, metal ribs, plastic tips and a wooden handle with a polyester canopy, closure with Velcro

Packing: 12/48 pieces | Size: Ø101 cm | Material: Metal/Polyester

Branding:

 280/170x210mm T2+H2

 280/170x210mm S1+H2

auto  58,5



56-0103046
navy blue



56-0103041
white



56-0103051
black



56-0103054
orange



*Come rain or shine,
we'll be together.*



HIP HOP

Aluminium stick umbrella "Hip Hop", with an aluminium shaft, metal ribs, a plastic crook handle in aluminium design with a polyester canopy, closure with Velcro

Packing: 12/36 pieces | Size: Ø101 cm | Material: Aluminium/Metal/Polyester

Branding:

 260/170x150mm T2+H2

 260/170x150mm S1+H2

 58,5



56-0103227
lilac



56-0103220
navy blue



56-0103221
light green



56-0103222
royal blue

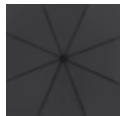

56-0103223
black

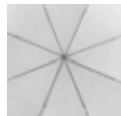

56-0103224
white



56-0103225
yellow

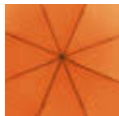

56-0103226
orange



SALSA

Automatic stick umbrella "Salsa" with a metal shaft and ribs, plastic tips, wooden grooved handle, polyester canopy, closure with Velcro

Packing: 12/48 pieces |

Size: Ø 102 cm |

Material: Metal/Polyester

Branding:

☰ Ø 24 mm D1

☰ 15 x 15 mm K1+H2

☰ 280/170 x 210 mm T2+H2

☰ 280/170 x 210 mm S1+H2

auto 



56-0103069
rainbow



56-0103064
blue/white



56-0103065
red/white

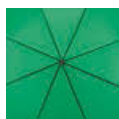

56-0103066
green



56-0103067
blue



56-0103068
red



LAMBARDA

Automatic umbrella "Lambarda" with metal shaft, fibreglass ribs, metal tips, rubber-coated crook handle with integrated press button, polyester pongee covering with special water-resistant coating, Velcro closure

Packing: 12/36 pieces | Size: Ø 103 cm |

Material: Metal/Fibreglass/Polyester

Branding:

☰ 260/170 x 150 mm T2+H2

☰ 260/170 x 150 mm S1+H2

auto 

> CREADO



56-0103324
petrol

 Pearl effect



56-0103320
navy blue



56-0103321
black



56-0103322
red

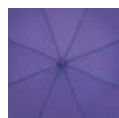

56-0103323
lilac



56-0103325
light green



56-0103326
royal blue



56-0103327
dark pink

WIND

Automatic windproof stick umbrella "Wind", with metal shaft, fibreglass ribs and metal tips with a rubber-coated crook handle and a polyester pongee canopy, closure with Velcro

Packing: 12/36 pieces | Size: Ø103 cm | Material: Metal/Fibreglass/Polyester

Branding:

 260/170x150mm T2+H2

 260/170x150mm S1+H2



56-0103267
light green

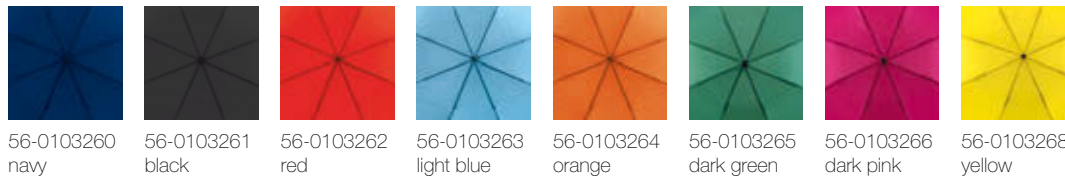

RUMBA

Automatic stick umbrella "Rumba" with an aluminium shaft, fibreglass ribs, metal tips, aluminium - EVA handle and a polyester pongee canopy and pouch, closure with Velcro

Packing: 12/36 pieces | Size: Ø103 cm | Material: Aluminium/Fibreglass/Polyester

Branding:

 Ø24mm D1

 280/170x210/100x50mm T2+H6

 50x10mm T1+H6

 280/170x210/100x50mm S1+H6



56-0103291
azure blue

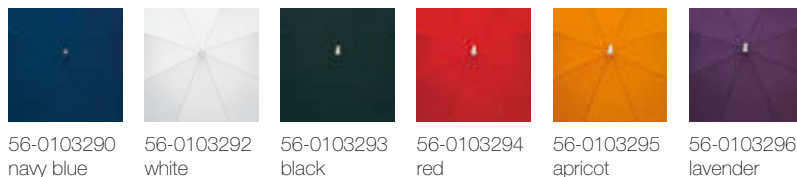

FLORA

Fibreglass stick umbrella "Flora" with carrying pouch, fibreglass shaft and fibreglass ribs, flower shaped short ribs, plastic tips with a black EVA handle and a nylon canopy, closure with Velcro

Packing: 12/36 pieces | Size: Ø 103 cm |
Material: Fibreglass/Nylon

Branding:

☞ 260/170x150mm T2+H6

☞ 260/170x150mm S1+H6



56-0103253
lilac

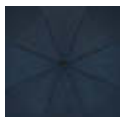

56-0103250
navy blue



56-0103251
black



56-0103252
grey



56-0103254
dark red

► CREADO



👍 Exceptionally stable



DOUBLY

Automatic stick umbrella "Doubly" with metal shaft, plastic tips and crook handle, double layered canopy with 2 colours, polyester canopy, closure with Velcro strap

Packing: 12/36 pieces | Size: Ø 103 cm |
Material: Metal/Polyester

Branding:

☞ 260/170x150mm T2+H2

☞ 90x10mm T1+H2

☞ 260/170x150mm S1+H2



👍 Double-sided canopy



56-0103073
black/yellow



56-0103070
black/blue



56-0103071
black/green



56-0103072
black/red



56-0103074
black/orange



56-0103075
black/grey



DISCO + DANCE

Automatic stick umbrella "Disco + Dance", with metal shaft, metal ribs, plastic tips with colour-matching plastic handle and a polyester canopy, closure with Velcro

Packing: 10/50 pieces | Size: Ø103 cm | Material: Metal/Polyester

Branding:

 260/170x150mm T2+H2

 260/170x150mm S1+H2



56-0103012
blue/white



56-0103002
black



56-0103006
yellow

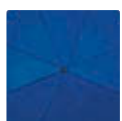

56-0103008
blue

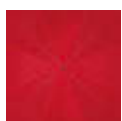

56-0103009
red



56-0103010
white



56-0103020
navy blue



56-0103005
blue/yellow



56-0103011
red/white



56-0103013
green/white



56-0103014
black/white



56-0103018
black/red



56-0103019
black/yellow



56-0103015
blue/green/red/yellow



TANGO

Automatic wooden stick umbrella "Tango", with metal ribs, wooden tips and a wooden crook handle with a polyester canopy, closure with Velcro

Packing: 12/36 pieces | Size: Ø103 cm | Material: Wood/Metal/Polyester

Branding:

 15x40mm K1+H2

 260/170x150mm T2+H2

 260/170x150mm S1+H2



56-0103146
light green

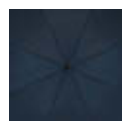

56-0103130
navy blue



56-0103131
dark green



56-0103132
white



56-0103133
black

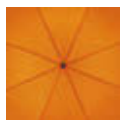

56-0103134
orange

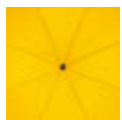

56-0103135
yellow



56-0103136
red

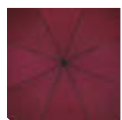

56-0103138
bordeaux



56-0103140
grey



56-0103141
dark brown



56-0103142
beige



56-0103145
royal blue



56-0103147
dark pink

BOOGIE

Automatic wooden stick umbrella "Boogie", metal ribs, wooden tips and a wooden crook handle with a nylon canopy, closure with Velcro

Packing: 12/36 pieces |

Size: Ø 103cm |

Material: Wood/Metal/Nylon

Branding:

☰ 15x40mm K1+H2

☰ 280/170x210mm T2+H2

☰ 280/170x210mm S1+H2

auto 

 Premium



56-0103234
orange

CREADO

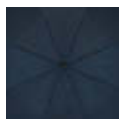

56-0103230
navy blue



56-0103231
dark green



56-0103232
white

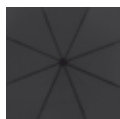

56-0103233
black



56-0103235
yellow



56-0103236
red



56-0103237
grey



56-0103238
bordeaux



56-0103239
beige

WALTZ

Automatic wooden stick umbrella "Waltz" with colour-matching piping, metal ribs, wooden tips and a wooden crook handle with a polyester canopy

Packing: 12/36 pieces |

Size: Ø 103cm |

Material: Wood/Metal/Polyester

Branding:

☰ 15x40mm K1+H2

☰ 260/170x150mm T2+H2

☰ 260/170x150mm S1+H2

auto 

 Coloured piping



56-0103093
black/grey



56-0103090
navy blue/beige



56-0103091
dark green/beige

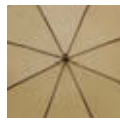

56-0103094
beige/brown





JIVE

Automatic stick umbrella "Jive": Metal shaft, fibreglass ribs and EVA handle are matching, metal tips – polyester pongee canopy with silver coating, closure with Velcro



Packing: 12/36 pieces | Size: Ø 103 |
Material: Metal/Fibreglass/Polyester Pongee

Branding:

-  240/160x160mm F2+H2
-  240/160x160mm T2+H2
-  240/160x160mm S1+H2

auto 



56-0103334
orange/silver



56-0103330
blue/silver



56-0103331
black/silver



56-0103332
red/silver



56-0103333
light green/silver





JOKER

Aluminium fibreglass stick umbrella "Joker": 290g light weight framework, with an aluminium shaft, fibreglass ribs, metal tips, EVA-handle and a polyester pongee canopy

Packing: 10/50 pieces | Size: Ø 106 cm |
Material: 290g Aluminium/Fibreglass/Polyester

Branding:

-  280/170x210mm T2+H2
-  280/170x210mm S1+H2



CREADO

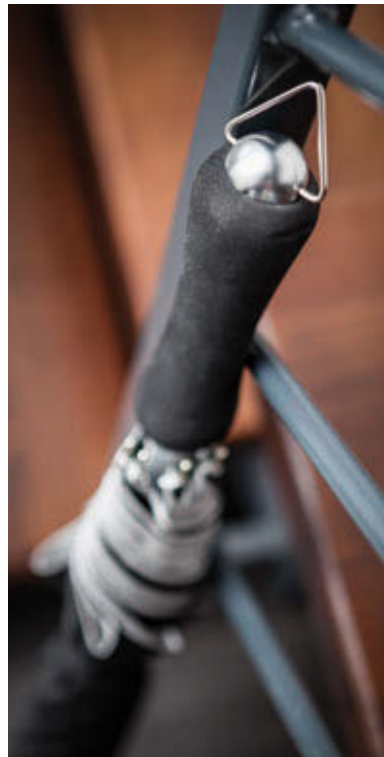

56-0103180
navy blue/silver



56-0103181
black/silver







56-0103184
red/silver

QUATRO

Square stick umbrella "Quatro" with an aluminium shaft, easy/safety opening, 4 panels, fibreglass ribs, metal tips with a silver colour - EVA designed handle and a polyester pongee canopy, closure with Velcro

Packing: 12/36 pieces | Size: Ø 120/Ø 80 cm |
Material: Aluminium/Fibreglass/Polyester

Branding:

-  Ø 24 mm D1
-  350/170x310mm T2+H2
-  50x10mm T1+H2
-  350/170x310mm S1+H2



56-0103276
light green

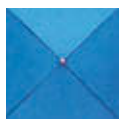

56-0103270
sky blue



56-0103271
black

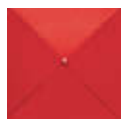

56-0103272
red

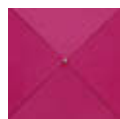

56-0103273
dark pink



56-0103274
orange



56-0103275
yellow





CREADO

TRIANGLE

Fibreglass stick umbrella "Triangle" with a fibreglass shaft and ribs, plastic tips, rubber-coated black handle, 190T polyester pongee canopy, 3 wide panels and 3 narrow panels, closure with Velcro

Packing: 12/24 pieces | Size: Ø 108 cm |
Material: Fibreglass/Polyester

Branding:

-  450/270x270mm T2+H2
-  50x10mm T1+H2
-  400/270x250mm S1+H2



56-0103245
khaki



56-0103241
black



56-0103242
dark red

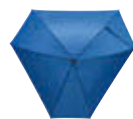

56-0103243
royal blue



56-0103244
violet



56-0103246
white

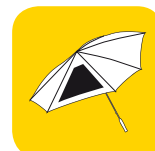

CREADO

registered design

SOLARIS

Aluminium fibreglass golf umbrella "Solaris", with an aluminium shaft, fibreglass ribs, metal tips with a colour-matching rubber crook handle and a polyester pongee canopy, closure with Velcro

Packing: 12/24 pieces | Size: Ø 120 cm | Material: Aluminium/Fibreglass/Polyester

Branding:

☂ 350/170x240mm T2+H2

☂ 300/170x210mm S1+H2



56-0104112
silver/red



👉 Silver on the outside -
coloured on the inside



SATELLITE 56-0104060

Aluminium fibreglass golf umbrella "Satellite", with an aluminium shaft, fibreglass ribs, metal tips and an aluminium handle with a polyester pongee canopy, closure with Velcro

Packing: 12/24 pieces | Size: Ø 118 cm | Material: Aluminium/Fibreglass/Polyester

Branding:

☂ Ø 29mm D1

☂ 15x15mm K1+H2+V1

☂ 280/170x210mm T2+H2

☂ 280/170x210mm S1+H2

☂ 15x15mm L1+H2



SUBWAY

Automatic golf umbrella "Subway" with black metal shaft, ribs and tips, black EVA crook handle with silver-coloured press button, polyester canopy with special water-resistant coating, closure with Velcro

Packing: 12/24 pieces | Size: Ø 119 cm | Material: Metal/Polyester

Branding:

☂ 280/170x210mm T2+H2

☂ 50x10mm T1+H2

☂ 260/170x150mm S1+H2



👉 Pearl effect

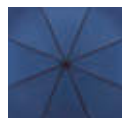

56-0104190
navy blue



56-0104191
black



56-0104192
white



56-0104193
azure blue



56-0104194
light green

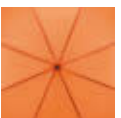

56-0104196
orange



56-0104197
lavender



PASSAT

Automatic wind proof umbrella "Passat" with metal shaft, fibre glass ribs, EVA handle, elegant umbrella top, polyester pongee canopy and Velcro closure

Packing: 12/24 pieces | Size: Ø 120 cm | Material: Metal/Fibreglass/Polyester

Branding:

☂ 350/170x240mm T2+H2

☂ 90x10mm T1+H2

☂ 300/170x210mm S1+H2

auto



56-0104182
red

CREADO



I'm weatherised!

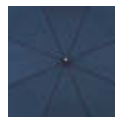

56-0104180
navy blue

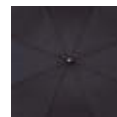

56-0104181
black



56-0104183
grey



MOBILE

Golf umbrella "Mobile" with carrying pouch, metal shaft, double metal ribs, plastic tips, EVA handle and coloured polyester canopy, closure with Velcro

Packing: 12/24 pieces | Size: Ø 125 cm |
Material: Polyester/Metal

Branding:

☂ 350/170x310mm T2+H6

☂ 250x35/50x10mm S1+H4

☂ 300/170x200mm S1+H6



56-0104145
orange



56-0104140
navy blue

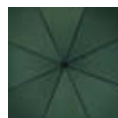

56-0104141
dark green



56-0104142
royal blue



56-0104143
black



56-0104144
red



56-0104146
yellow



56-0104147
light green



RAINY + WALKER

Golf umbrella "Rainy + Walker", with metal shaft and double metal ribs, plastic tips, natural coloured wooden ribbed handle, polyester canopy and Velcro closure

Packing: 12/24 pieces | Size: Ø 131 cm |

Material: Metal/Polyester

Branding:

 350/170x240mm T2+H2

 300/170x210mm S1+H2



56-0104088
yellow



56-0104080
white



56-0104085
black



56-0104086
blue

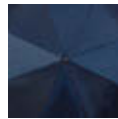

56-0104090
navy blue



56-0104137
red



56-0104131
green/white



56-0104132
red/white



56-0104133
blue/white



56-0104134
black/white

TORNADO

Windproof umbrella "Tornado", with fibreglass shaft, plastic tips, black-coated double metal ribs and windproof suspension with fast return and an EVA-handle with a polyester canopy, closure with Velcro

Packing: 12/24 pieces | Size: Ø 131 cm |

Material: Metal/Fibreglass/Polyester

Branding:

 350/170x240mm T2+H2

 300/170x210mm S1+H2



56-0104043
black



 Windproof



56-0104040
navy blue

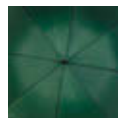

56-0104041
dark green



56-0104044
grey

i Windproof function: Usually umbrellas break when the umbrella canopy is blown back by the wind. Umbrellas with windproof function have a flexible frame, thus the umbrella roof can fold back without any damage.

MONSUN

Fibreglass golf umbrella "Monsun" with a ventilation system, fibreglass shaft and ribs, plastic tips and plastic handle with a nylon canopy, closure with Velcro

Packing: 12/24 pieces | **Size:** Ø 132 cm |
Material: Fibreglass/Nylon

Branding:

☂ Ø 30 mm D1

☂ 350/170x240mm T2+H2

☂ 300/170x210mm S1+H2



☑ Allows the wind to blow through



56-0104174
black/orange



CREADO



56-0104170
black/royal blue



56-0104171
black/dark green



56-0104172
black/red



56-0104173
black/grey

CONCIERGE

Giant golf umbrella "Concierge" with extra large diameter of 180cm for approx. 7 persons, fibreglass shaft and ribs, with safety runner, plastic tips, rubber-coated handle, polyester pongee canopy and pouch, closure with Velcro

Packing: 6/12 pieces | **Size:** Ø 180 cm |
Material: Fibreglass/Polyester

Branding:

☂ 300x200mm S1+H7



XXL
print



56-0104212
light grey



56-0104210
navy blue

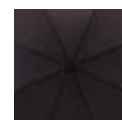

56-0104211
black

☑ extra large Ø 180 cm

CREADO



PANORAMIX 56-0103035

Transparent aluminium stick umbrella "Panoramix" with metal ribs, plastic tips and crook handle with a POE canopy

Packing: 12/36 pieces | Size: Ø101 cm | Material: Aluminium/Metal/POE

Branding:

☒ 280/170x210mm S1+H2+V3

☒ 58,5

**OBSERVER** 56-0104036

Big transparent aluminium stick umbrella "Observer": metal ribs and tips, comfortable black foam rubber handle, transparent POE canopy with black piping, and press button fastener

Packing: 12/24 pieces | Size: Ø110 cm | Material: Aluminium/Metal/POE

Branding:

☒ 280/170x210mm S1+H2+V3

☒ 65



 **NEW**

BELLEVUE 56-0104034

Dome shape umbrella "Bellevue": metal shaft and ribs, plastic tips and top, transparent plastic handle with air bubble effect, transparent POE canopy with silver piping, and press button fastener

Packing: 12/24 pieces | Size: Ø101 cm | Material: Metal/POE

Branding:

☒ 70x10mm K1+H2

☒ 240/140x200mm S1+H2

☒ 70x12mm L1+H2

☒ 68,5



 **NEW**

 Handle with air bubble effect



PANORAMIC

Transparent automatic shoulder strap umbrella "Panoramic", with metal shaft, metal ribs, plastic tips and a plastic handle with a POE canopy

Packing: 12/60 pieces | Size: Ø96 cm |
Material: Metal/POE

Branding:

 10x15mm K1+H2
 230/170x140mm S1+H2+V3

auto  54



56-0102080
transparent/blue

56-0102081
transparent/red

56-0102082
transparent/white

56-0102083
transparent/yellow

56-0102084
transparent/orange

56-0102085
transparent/black



I see everything.



LOLLIPOP 56-0105009

Children's umbrella "Lollipop" with a safety opening, metal shaft and ribs, plastic tips with a colour-matching plastic crook handle and a polyester canopy

Packing: 12/60 pieces | Size: Ø69 cm |
Material: Metal/Polyester

Branding:

 120/80x100mm T2+H2
 120/80x100mm S1+H2

 40



ARTIST 56-0105016

Children's umbrella "Artist" to draw on with a safety opening, with metal shaft and ribs, plastic tips and yellow plastic crook handle with a polyester canopy, includes 4 crayons

Packing: 12/60 sets | Size: Ø69 cm |
Material: Metal/Polyester

Branding:

 120/80x100mm T2+H6
 120/80x100mm S1+H6

 40

 For children



SUNFLOWER

Beach umbrella "Sunflower" with 2-piece metal shaft, metal ribs, plastic tips, polyester covering, packed in clear PVC carrying bag

Packing: 12 pieces | Size: Ø145 cm |
Material: Metal/Polyester

Branding:

 380/220x300mm T2+H3
 380/220x300mm S1+H2



56-0106003
yellow



56-0106000
white



56-0106001
blue



56-0106002
red



56-0106004
light green

SANDY 56-0106901

Beach umbrella holder "Sandy": easy to dig into ground thanks to spiral cone, with handle and locking screw

Packing: 12/72 pieces | Size: Ø10x43cm

Branding:

 20x10mm K2+H2
 20x10mm L5+H2

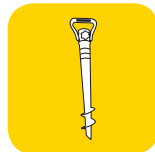

 Easy to carry



I love the shady sides of life too.



ALOHA

Sun and beach umbrella "Aloha": 2-piece metal shaft with swivel joint, metal ribs, plastic tips, polyester canopy, umbrella segments with wide flounces, colour-matching polyester carrying bag

Packing: 6/12 pieces | Size: Ø160cm | Material: Metal/Polyester

Branding:

☒ 65x140/350/200x340mm T2+H6

☒ 65x140/350/200x340mm S1+H6



56-0106010
white



56-0106012
red



56-0106013
blue/white



56-0106011
blue



SERVICE & QUALITY

OFFICE & BUSINESS

MUSIC & TIME

LIGHTS & TOOLS

SAVE & PRACTICAL



LEISURE & FUN

➤ „How cool is that?“

Here I find everything I enjoy. Ball games for the beach and crayons for rainy days. For the little ones, there are plush toys. And adults are in for a treat when looking for barbecue and gardening accessories. Have a great time indoors and outdoors!

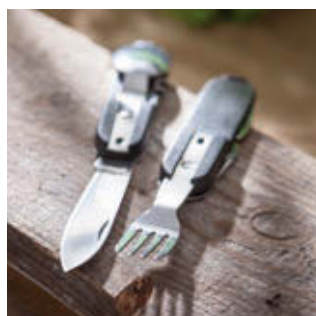

HAWAII 56-0106055

Garden and beach umbrella "Hawaii": diameter of approx. 268cm provides lots of shade, with 2-piece wooden shaft (3,8 cm diameter) and wooden ribs, special rope pull system to open, weatherproof polyester straw-like covering, without stand

Packing: 1 piece | Size: approx. Ø268 cm | Material: Wood/Polyester

 Ø 2,68 m



MAMMUT 56-0106905

Umbrella stand "Mammut": metal holding rod with locking screw, solid metal and concrete stand for good adhesion, weight approx. 15 kg

Packing: 1 piece | Size: Ø45 cm | Material: Metal/Cement

Branding:

- 40x20mm E1
- 80x40mm E3

 Approx. 15 kg



EVENING DREAMS

Solar bottle "Evening dreams" made from coloured milky glass with decorative band to hang up, with integrated solar panels in the bottle and rechargeable battery, the light goes on when it gets dark, ON/OFF button on the bottom of the bottle, packed in gift box

Packing: 28 pieces | Size: Ø7,2x24,5 cm | Material: Glass

Branding:

☒ 20x25mm K2+H4

☑ 20x25mm L4+H4



56-0601038
green

56-0601039
white

56-0601037
lilac

56-0601040
turquoise

CELEBRATION

Solar jar "Celebration" with white LED, integrated solar panel on the top, battery saves the energy supplied by the sun, light sensor reacts when it gets dark, ON/OFF button under the lid, packed in a gift box

Packing: 48 pieces | Size: Ø8,5x12 cm

Branding:

☒ 20x30mm K2+H4

☑ 25x16mm L1+H4



56-0601045
blue

56-0601046
green

56-0601047
orange

56-0601048
red



ADJUSTABLE 56-0699988

Camping torch "Adjustable": 1 white LED with 3 different modes (steady, dimmed, and flashing light) and pull-out part for 360° light, usable as torch, rubber-coated on/off button, robust, lightweight plastic housing with practical handle that can be used to hang up, packed in gift box

Packing: 50/100 pieces | Size: Ø3,8x10-14 cm

Branding:

☒ 12x40/12x12mm K1+H4+V1



AAA/LR03/AM4

3 light modes



COLLECT 56-0601042

Solar lamp "Collect" with white light, stainless steel shaft, plastic ground spear, integrated solar panel with rechargeable battery, light comes on when it gets dark, ON/OFF button under the lamp, packed in gift box

Packing: 50 pieces | Size: Ø5,5x36,5 cm |
Material: Stainless Steel

Branding:

☞ 30x7 mm K2+H4+V1

☞ 12x15 mm L1+H4

☞ 30x7 mm L5+H4



There's lots to do.

**GO GREEN**

Gardening set "Go Green": consists of 1 knee pad and 1 pair of gloves with non-slip nubs on the palm

Packing: 60 sets | Size: 34,6x16x1,7 cm

Branding:

☐ 80x40mm E3



56-0601026
green



56-0601028
yellow



56-0601027
blue

BOTANIC 56-0601030

7 piece gardening set "Botanic", consists of a rake, 2 shovels, secateurs, wire and spray bottle, packed in a canvas bag with pockets on the outside and strengthened handle

Packing: 25 pieces | Size: 18x10x19 cm

Branding:

 60x70mm T1+H3

**EVERGREEN** 56-0601011

Garden apron "Evergreen" with pockets for 2 hooks, 3 spades, 2 rakes and a spray bottle

Packing: 20 pieces | Size: 55x51 cm

Branding:

 100x100mm T2+H3

**FAUNA** 56-0601043

Solar lamp "Fauna" with tree trunk and bird, solar panel on the side and rechargeable battery, light comes on when it gets dark, ON/OFF button on the bottom, packed in gift box

Packing: 30 pieces | Size: 9,5x10x16 cm

Branding:

 40x20mm E1



 Solar



SNOOZE 56-0606037

Hammock "Snooze": with interweaved ropes as suspension, capacity of approx. 100 kg, packed in cloth bag with drawstring and plastic stoppers

Packing: 20 pieces | Size: 200x80cm |
Material: 85% Cotton/15% Polyester

Branding:

-  350x250/200x200mm F2+H8
-  350x250/200x200mm T2+H8
-  350x420/150x200mm S2+H8

 Max. 100 kg



SIESTA 56-0606034

Cotton hammock "Siesta" with wooden rope feedthroughs (max. 100 kg)

Packing: 10 pieces | Size: 200x80cm |
Material: Cotton (220g/m²)

Branding:

-  360x360mm T2+H6



 Max. 100 kg



HANG OUT 56-0606035

Hanging chair "Hang out" on a strong wooden rod with randomly twisted ropes (max. 100 kg)

Packing: 4 pieces | Size: 110x116cm |
Material: 100% Cotton 280g/m²

Branding:

-  350x350mm T2+H6



 Max. 100 kg



BEDTIME

Sleeping bag "Bedtime" (190x75 cm): thanks to all around zip also usable as a duvet (190x155 cm), high sleeping comfort, in colour-matching carrying bag with pullable cord and plastic stopper, weighs approx. 1 kg

Packing: 10 pieces | Size: Ø30x49 cm |
Material: 100% Polyester

Branding:

200x140/300x120 mm T2+H6



XXL
print

56-0603512
light blue

👉 Usable also as a blanket



56-0603511
dark blue



56-0603513
light green



56-0603514
red



56-0603515
pink

MONODOME 56-0603500

Igloo tent "Monodome" for 2 people with fibreglass rods, mosquito net on the entrance and roof, packed in a bag with a handle

Packing: 10 pieces | Size: 120x200x95 cm

Branding:

120x100 mm T2+H6

180x145 mm T2+H6

90x40 mm T2+H6



TIEBACK

LED light "Tieback": looks like a light bulb, white LED light (1 Watt), pull the cord to switch on or off – ideal for garage, wardrobes and tent

Packing: 40/80 pieces | Size: Ø5,5x16 cm

Branding:

45x15 mm K1+H2

30x10 mm L1+H2

3x
EXCL.

AAA/LR03/AM4



🛒 NEW



56-0403146
black/white



56-0403147
blue/white



56-0403148
green/white



TRANSIT

Aluminium drinking bottle "Transit" with matching colour snap hook and plastic closure, capacity approx. 400 ml

Packing: 48 pieces | Size: Ø6,5x17,5 cm |

Material: Aluminium

Branding:

☑ 25x40mm K2+H4

☑ 25x40mm L2+H4



56-0603038
black

56-0603039
green

56-0603040
blue

56-0603041
red

56-0603042
purple

56-0603043
orange

56-0603044
silver



WILDLIFE 56-0301017

7 piece stainless steel multifunctional tool set "Wildlife" includes a fold-out knife, bottle and can opener, tool for descaling and a cork screw, pull-out fork and spoon, with a key ring, packed in a bag with an integrated belt loop and Velcro fastener

Packing: 10/100 pieces | Size: 11,2x2,5 cm |

Material: Stainless Steel/600D

Branding:

☑ 15x15mm T1+H5

☑ 10x6mm L1+H5



CAMPING 56-0301018

3 piece outdoor cutlery set "Camping" consists of a foldable knife, fork and a spoon with a bottle and can opener packed in a nylon bag with a Velcro fastener and a carrying handle

Packing: 10/100 pieces | Size: 16,2x1,5 cm

Branding:

☑ 30x5mm K1+H6+V1

☑ 40x50mm T1+H5

☑ 40x6mm L1+H6



WOOD 56-0301005

Pocket knife "Wood" with wooden area, consists of a pair of scissors, nail file, bottle opener, corkscrew, screwdriver, can opener, tool for descaling, saw, splicer and piercing tool, packed in a wooden case

Packing: 25/50 pieces | Size: 9x2,5x1,5 cm |
Material: Stainless Steel/Wood

Branding:



-  25x25mm K1+H2
-  40x10mm K1+H4+V2
-  60x20mm DP2+H2
-  22x22mm L4+H2
-  40x10mm L1+H4

**TRIO** 56-0301052

11 piece pocket knife "Trio" with stripes design, with a can opener, bottle opener, corkscrew, piercing tool, nail file, Phillips screwdriver, a pair of scissors, 2 saws, tool for descaling, awl, splicer and key ring

Packing: 25/100 pieces | Size: 10x3x2 cm |
Material: Stainless Steel

Branding:

-  45x7 mm A1+H2
-  50x5/20x10mm K1+H2+V1
-  45x7 mm L1+H2

**ALL TOGETHER**

11 piece pocket knife "All together" with pair of scissors, knife, 1 large and 1 small saw, can opener, bottle opener, corkscrew, nail file, pricker, hole maker and screwdriver, packed in gift box

Packing: 25/100 pieces | Size: 10,5x3x2,5 cm |
Material: Stainless Steel

Branding:

-  40x6 mm K1+H4+V2
-  40x6mm DP1+H2
-  40x6mm L1+H4



56-0301131
orange



56-0301130
blue



56-0301132
silver



56-0301133
green



METALLIC 56-0301012

Big stainless steel jackknife "Metallic"

Packing: 12/240 pieces |

Size: 10x3,5x0,6cm |

Material: Stainless Steel

Branding:

☞ 55x15mm K1+H2+V1

☞ 55x15mm DP1+H2

☞ 20x10mm L1+H2

**SMALL R.** 56-0301007

7 piece pocket knife "Small R." consisting of scissors, knife, can opener, bottle opener, cork screw, file and Phillips screwdriver, including key ring, in a gift box

Packing: 50/100 pieces | Size: 8,5x2,4x1,4cm |

Material: Stainless Steel

Branding:

☞ 20x3mm K1+H3+V1

☞ 20x3mm L1+H3

**BIG R.** 56-0301009

11 piece pocket knife "Big R." consisting of scissors, large saw, small saw, knife, can opener, bottle opener, cork screw, pricker, file, hole puncher and Phillips screwdriver, including key ring, in a gift box

Packing: 50/100 pieces |

Size: 10,5x2,8x1,8cm | Material: Stainless Steel

Branding:

☞ 20x5mm K1+H3+V1

☞ 20x5mm L1+H3





HUNTER 56-0301006

Jackknife "Hunter" with large blade with wood application on the handle and belt clip, packed in a wooden gift box

Packing: 10/40 pieces |

Size: 11,5x3,3x2 cm

Branding:

10 25x10mm K2+H4+V1

10 25x25mm K1+H2

10 70x25mm DP2+H2

10 22x22mm L4+H2

10 25x10mm L4+H4



SURVIVOR 56-0301003

Noble jackknife "Survivor" with birchwood handle, packed in a wooden case

Packing: 25/100 pieces |

Size: 10,5x2,9x1,8 cm |

Material: Stainless Steel/Wood

Branding:

10 10x40mm K1+H3+V1

10 25x25mm K1+H2

10 30x8mm K1+H3

10 70x15mm DP1+H2

10 22x22mm L4+H2



FOREST 56-0301002

11 piece wooden pocket knife "Forest" with a pair of scissors, nail file, bottle opener, corkscrew, screwdriver, can opener, pricker, splicer, tool for descaling, saw and key ring, packed in a wooden case

Packing: 25/50 pieces | Size: 9,4x2,4x2,1 cm |

Material: Stainless Steel/Wood

Branding:

10 10x40mm K1+H4+V2

10 25x25mm K1+H2 | 10 70x25mm DP2+H2

10 25x25mm L4+H4



STAY COOL

Barbecue glove "Stay cool": partly quilted, made of cotton, with rubberized grip surface and loop for hanging

Packing: 80 pieces | Size: 30x16x1,5 cm

Branding:

 80x80mm T1+H2



56-0604057
light green/black



56-0604058
black

 Silicone grip area

EVEREST 56-0604050

Cone-shaped grill "Everest": top container made of stainless steel, with removable plate with 2 ventilation holes, 3-stage adjustable grill grid with wooden handles, pillar with vent window and ash collection tray, stable base, packed in a gift box

Packing: 1 piece | Size: 56x38x93,5 cm | Material: Stainless Steel

Branding:

 80x40mm L2+H8

 40x20mm E1



MASTER 56-0604010

Round barbecue grill "Master" with lid, grid and 2 wheels, packed in a gift box

Packing: 1 piece | Size: Ø47 x 75 cm



without decoration



CHARCOAL 56-0604068

Barbecue "Charcoal": 2-piece hinged metal corpus, secure latch, with 1 air vent in lid as well as air inlets at the side, 3 removable cooking grates, 2 removable handles to lift cooking grate, practical carrying handle for transportation, 4 fold-out metal feet – suitable for picnics and camping

Packing: 4 pieces | Size: 40x35x32 cm | Material: Carbon Steel

Branding:

🔪 100x100mm L2+H4



 NEW



SUMMER SEASON 56-0301113

18 piece barbecue set "Summer season" packed in a silver case

Packing: 4 pieces | Size: 50x27x10 cm | Material: Aluminium/Stainless Steel

Branding:

🔪 40x10mm L2+H4

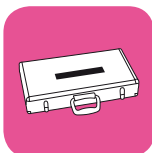

ROAST 56-0604016

Stainless steel barbecue cutlery "Roast", consists of a spatula, grill fork and grill tong, packed in a silver case with carrying handle and hinge-joint

Packing: 10 pieces | Size: 37x10x8 cm | Material: Stainless Steel/Aluminium

Branding:

🔪 45x25mm K1+H4+V2

🔪 45x25mm L2+H4





HAPPY MEAL 56-0604014

American barbecue "Happy Meal" with lid, includes a tong, packed in a gift box

Packing: 4 pieces | Size: Ø 25x38 cm |
Material: Stainless Steel

Branding:

📏 50x10mm L2+H7



FRIED 56-0604015

High-quality stainless steel grill cutlery "Fried" with wooden handles packed in a bag with a zip

Packing: 10 pieces | Size: 43x33,5 cm |
Material: Stainless Steel/600D Polyester

Branding:

📏 200x100mm T2+H3

📏 60x15mm L5+H5



HAPPY DAY 56-0604052

Foldable grill "Happy Day": with one grill rack to lay in, foldable metal case with ventilation holes, 2 foldable handles, weighs only 1,8 kg, size when folded approx. 33x25x1 cm, packed in a giftbox

Packing: 6 piece |
Size: 32,5x32,5x24/33x25x1 cm

Branding:

📏 40x20mm E1

📏 80x40mm E3



Extra flat





BUCKET

Barbecue "Bucket": large cooking grate with fold-out handles, 1 additional small cooking grate, removable charcoal tray, 4 air holes, 3 fold-out metal feet on the bottom – suitable for picnics and camping

Packing: 6 pieces | Size: Ø26x18 cm |

Material: Carbon Steel

Branding:

☑ 40x30mm L2+H8



56-0604064
black



56-0604065
orange



56-0604066
light blue

2IN1 56-0604019

Picnic barbecue bag "2in1": with zip fastening cool bag for groceries and drinks, adjustable and removable shoulder belt, 10 piece grill cutlery (including zip fastening pocket on the front side)

Packing: 10 pieces | Size: 39,5x24x24 cm |

Material: 600D Polyester/Stainless Steel

Branding:

☑ 120x60/220x100mm T2+H5



 Insulated cooling pocket



TIP TOP 56-0604053

Hand grill cleaner "Tip Top": with 3 different cleaning surfaces: brass bristles, PU sponge, and metal scraper on solid plastic handle for thorough cleaning of grills

Packing: 25/100 pieces | **Size:** 12x11x7 cm

Branding:

🔪 30x10mm L5+H2

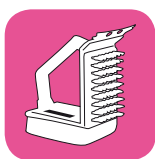
**AIRBORNE** 56-0604051

Manual barbecue fan "Airborne": with side crank to generate air blow, plastic body with metal pipe and shaft – perfect to fire up the charcoal

Packing: 50 pieces | **Size:** 25x8x4,8cm

Branding:

🔪 25x10mm K2+H4

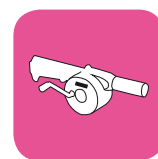

👉 Manual BBQ fan

**COOKOUT**

Kettle barbecue "Cookout": metal body with 2 vent windows, removable tray with air holes for coal, 1 removable grill rack Ø approx. 29cm, lid with vent window and wooden handle, 3 buckles to close the lid on metal body, 3 metal feet with plastic caps, packed in a giftbox

Packing: 4 pieces | **Size:** Ø31,5x43 cm

Branding:

🔪 20x10mm L4+H8

☐ 40x20mm E1+H2

☐ 80x40mm E3+H2



56-0604055
red



56-0604054
light green



56-0604056
blue



NICE TO HAVE 56-0604018

Picnic grill "Nice to have" with transport bag, metal grill with 2 grids and 2 metal feet, carrying bag with zip pocket, integrated cooler pocket, removable and adjustable shoulder strap, packed in a gift box

Packing: 4 pieces | Size: Ø30x20 cm

Branding:

85x85mm T2+H7



 Integrated cooling pocket

**OPEN-AIR**

Picnic blanket "Open-air" made out of soft fleece with coloured border and a carrying handle

Packing: 32 pieces | Size: 180x120 cm | Material: Polyester

Branding:

100x30mm T2+H4

100x30mm N1+H4

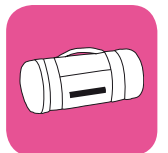

56-0604000
blue



56-0603996
red



56-0603997
green



56-0603999
black



SUMMERTIME 56-0604032

Willow picnic basket "Summertime" for 4 persons with champagne plastic glasses and ceramic plates - forks, spoons and knives, with a carrying handle on the side, holders, shoulder strap and twist locks

Packing: 4 pieces | **Size:** 43x30x31,5cm

Branding:

☰ 20x20mm K2+H9

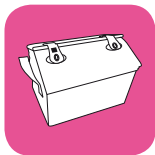

👉 For 4



without decoration



CENTRAL PARK 56-0604007

Picnic basket "Central Park" with shoulder strap, includes porcelain dishes for 2 persons, cutlery, flask and a table cloth

Packing: 4 pieces | **Size:** 41x31x19cm

👉 For 2



without decoration

SIT DOWN 56-0604005

Checked picnic blanket "Sit down" with coated, soil-resistant bottom

Packing: 20 pieces | **Size:** 127x152cm

Branding:

☰ 100x30mm T1+H2

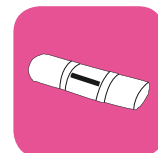

👉 Coated soil-resistant bottom

COFFEE 56-0604009

Picnic rucksack "Coffee" for 2 persons with cutlery, mugs and a stainless steel flask, bread knife, fabric napkins, wooden cutting board, 2 stainless steel containers for milk and sugar, without picnic blanket

Packing: 6 pieces | Size: 27 x 18 x 35 cm |
Material: 600D/Stainless Steel

Branding:

☞ 150x200mm T2+H6



☝ For 2



without decoration

GET-TOGETHER

Picnic cutlery set "Get-together", 4 pieces: consists of knife, fork, spoon and cutlery case for storage – cutlery can be put together easily, made of solid plastic

Packing: 100/300 pieces |
Size: 3,2 x 1,5 x 17,5 cm

Branding:

☞ 40x10/20x10mm K1+H2



56-0604060
blue

56-0604061
white

56-0604062
red

MADISON PARK 56-0604034

Picnic basket "Madison Park" for 4 people: insulated zip cool compartment, incl. cutlery with plastic handles, ceramic plates - secured with straps - and picnic blanket with coated, soil-resistant surface and lower side, convenient carrying handle on the outside

Packing: 4 pieces | Size: 46x30x21 cm

Branding:

☞ 300x300mm T2+H6

☞ 80x80mm T1+H6



without decoration

☝ For 4



GREEN PARK 56-0604002

Bamboo picnic basket "Green Park" with plastic cutlery for 4 persons and table cloth

Packing: 6 pieces | Size: 46x30x20cm



👍 For 4

without decoration

OUTSIDE

Picnic backpack "Outside" for 2 persons, with an insulated main pocket, front pocket with plastic handled cutlery, 2 plastic plates and glasses, 2 fabric napkins, 2 net pockets on the sides, carrying handle and padded shoulder straps

Packing: 12 pieces | Size: 27x14x37 cm | Material: 600D Polyester

Branding:

≡ 100x80mm T2+H6



56-0604043
black

👍 Insulated
cooling pocket

56-0604042
blue/grey

DIABOLO 56-0604026

Picnic rucksack "Diabolo" for 2 persons with high-quality coated fleece blanket and insulated bag and drink holder

Packing: 4 pieces | Size: 39x33x29cm | Material: 600D Polyester

Branding:

≡ 110x80mm T2+H3



👍 Blanket with coated
soil bottom



without decoration



HYDE PARK 56-0604020

Picnic rucksack "Hyde Park" for 4 persons with built-in cooler bag, includes cutlery, plastic dishes and wine glasses, cheese knife, waiter's knife, fabric napkins, salt and pepper mill and cutting board



Packing: 6 pieces | Size: 28x21x39 cm |
Material: 600D Polyester

Branding:

100x80mm T2+H6

For 4

**COOL MUSIC** 56-0602101

Insulated box "Cool music" with radio, headphone attachment, reception adaptor and handle, approx. 4 litre capacity



Packing: 6 pieces | Size: 30x24x22 cm

Branding:

45x10mm K2+H2



AA/LR6/AM3



approx. 4 liters

**MC COOL** 56-0310020

Mini fridge "Mc Cool" with a fold-out carrying handle, 12 volt connection (plugs into the cigarette lighter) and 220 - 240 volt main connection, approx. 4 litre capacity



Packing: 4 pieces | Size: 27,5x19,4x27,7 cm

Branding:

60x20mm K2+H6



approx. 4 liters

**HOT AND COOL** 56-0310010

Mini fridge /mini warmer "Hot and Cool" with handle, 12V connection (plugs into the cigarette lighter) and 230V main connection

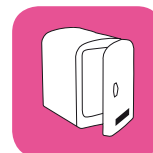

Packing: 4 pieces | Size: 18,4x25,5x27,6 cm

Branding:

60x20mm K2+H6



approx. 4 liters



FAVOURITE

5-panel cap "Favourite" with strengthened front segment, 2 embroidered vent holes, button, size-adjustable Velcro closure at the back

Packing: 50/200 pieces | Size: one size

Branding:

☐ 90x50mm T3

☞ 90x50mm N1



56-0702057
light blue



56-0702050
light green



56-0702051
dark blue



56-0702052
red



56-0702053
yellow



56-0702054
dark green



56-0702055
black



56-0702056
white



56-0702058
orange



56-0702059
pink

RACING

5 panel cap "Racing" with an adjustable plastic fastener and metal air vents on the top

Packing: 50/200 pieces | Size: one size |
Material: 100% Cotton

Branding:

☐ 95x60mm T3

☞ 95x60mm N1



56-0702044
green



56-0702041
blue



56-0702042
red



56-0702043
yellow



56-0702045
black



56-0702046
white



56-0702047
navy blue



56-0702048
orange

ATHLETE

5 panel cap "Athlete" with coloured visor, metal air vents, coloured button on the top and an adjustable plastic fastener

Packing: 50/200 pieces | Size: one size |
Material: 100% Cotton

Branding:

☐ 95x60mm T3

☞ 95x60mm N1



56-0702067
white/blue



56-0702062
white/red



56-0702064
white/green



LIBERTY

6 panel sandwich cap "Liberty", heavy brushed cotton, embroidered air vents, Velcro fastener and strengthened front segment

Packing: 50/200 pieces | **Size:** one size |
Material: 100% Cotton

Branding:

☰ 50x40mm T3
⌘ 50x40mm N1

56-0702182
orange



 New colours



56-0702174
pink



56-0702175
yellow



56-0702176
light green



56-0702177
blue



56-0702178
beige



56-0702180
white



56-0702181
red



56-0702183
navy blue



56-0702184
black

WALK

5 panel sandwich cap "Walk", heavy brushed cotton, reinforced front segment, 4 embroidered air holes, adjustable Velcro fastener at the back

Packing: 50/200 pieces | **Size:** one size |
Material: 100% Cotton

Branding:

☰ 90x50mm F2
☰ 90x50mm T3
⌘ 50x40mm N1

 NEW



56-0702096
red



56-0702090
white



56-0702091
black



56-0702092
light green



56-0702093
blue



56-0702094
yellow



56-0702095
pink



56-0702097
orange



56-0702098
dark blue

DETECTION

6 panel cap "Detection" with reflector band on the peak and Velcro at the back, embroidered holes, strong peak, 100% cotton (heavy-brushed)

Packing: 50/200 pieces | Size: one size

Branding:

☞ 80x60mm T3

☞ 80x60mm N1

56-0702165
red



☞ Reflects



56-0702160
white



56-0702161
orange



56-0702162
black



56-0702163
grey



56-0702164
blue



SOLDIER

Military cap "Soldier" with casual army style, made from strong cotton, 4 metal air holes on the sides and a metal closure on the back

Packing: 50/200 pieces | Size: one size |

Material: 100% Cotton

Branding:

☞ 50x30mm T3

☞ 50x30mm N1

56-0702103
mocca



56-0702104
anthracite



56-0702100
sand



56-0702101
red



56-0702102
dark green

SHINY

5 panel cap "Shiny", 2-coloured: easy to print reinforced front segment, 4 embroidered air holes, adjustable Velcro fastener at the back

Packing: 50/200 pieces | Size: one size | Material: 100% Polyester

Branding:

- ☛ 30x50mm F2
- ☛ 30x50mm T3
- ☛ 30x50mm N1



56-0701802
green



 Neon



56-0701800
orange



56-0701801
yellow



56-0701803
pink

PITCHER

6 panel cap "Pitcher": reinforced front segment in canvas look, other segments with mesh, 2 embroidered air holes, adjustable Velcro fastener at the back

Packing: 50/200 pieces | Size: one size | Material: 100% Polyester

Branding:

- ☛ 90x50mm F2
- ☛ 90x50mm T3
- ☛ 90x50mm N1



56-0701702
dark blue



56-0701700
white



56-0701701
black



56-0701703
red



56-0701704
royal blue



56-0701705
orange



56-0701706
apple green

SHADOW

Sun hat "Shadow" made out of soft cotton

Packing: 50/300 pieces | Size: one size | Material: 100% Cotton

Branding:

☰ 100x35mm T3

☞ 100x35mm N1



56-0702001
blue



56-0702002
red



56-0702003
yellow



56-0702004
green



56-0702006
white

CALIMERO

5 panel cap for children "Calimero" with coloured visor, button, embroidered air vents, Velcro fastener with strengthened front segment

Packing: 50/200 pieces | Size: one size | Material: 100% Cotton

Branding:

☰ 80x40mm T3

☞ 100x60mm N1



56-0702125
yellow/orange



56-0702126
red/blue



WICKIE

Children's legionnaire hat "Wickie": enforced peak, long neck guard, elastic band with plastic stopper to adjust the size, 4 embroidered air holes – ideal for outdoor activities and sun protection

Packing: 50/200 pieces | Size: one size

Branding:

☰ 90x50mm T3

☞ 90x50mm N1



56-0702111
white



56-0702112
blue



56-0702113
red

NORDIC

Reversible hat "Nordic"

Packing: 100/200 pieces | Size: one size |

Material: 100% acrylic

Branding:

Ø 40x20mm N1

 Reversible cap



56-0702601
navy blue/royal blue



56-0702602
black/red



56-0702603
silver/black



TRIPLE

Soft polar fleece set "Triple", consists of a hat, scarf with fringe effect and gloves with a plastic closure to join the two gloves together, includes a printable label

Packing: 50/100 sets | Size: one size |

Material: 100% Polyester

Branding:

 180x300mm T2+H2

 45x20mm T1+H2



56-0702801
royal blue



56-0702802
red



56-0702800
black

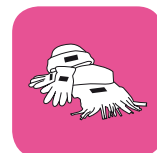

VARIOUS

Fleece scarf-hat "Various": in 2 styles to wear – scarf can be turned into a hat by pulling the elastic string with stopper

Packing: 50/100 pieces | Size: 27,5x27,5cm |

Material: 100% Polyester

Branding:

 200x160mm T2



56-0702720
white



56-0702721
black



56-0702723
petrol



56-0702722
navy blue

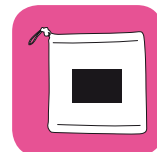

 2 in 1



ICEBREAKER

Polar fleece scarf "Icebreaker" with fringe

Packing: 50/100 pieces | Size: 145x24 cm |

Material: 100% Polyester

Branding:

☰ 150x120mm T2

☞ 150x120mm N1



56-0702300
navy blue



56-0702305
black

ANTARCTIC

Polar fleece gloves "Antarctic" with plastic fastener to join the gloves together

Packing: 50/100 pair | Size: one size |

Material: 100% Polyester

Branding:

☰ 40x30mm T1



56-0702405
black



56-0702400
navy blue

BLIZZARD

Polar fleece headband "Blizzard" with ear warmers

Packing: 50/100 pieces | Size: one size |

Material: 100% Polyester

Branding:

☰ 100x30mm T2

☞ 100x30mm N1

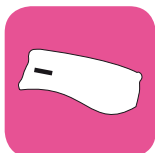

56-0702700
navy blue



56-0702705
black

SWITCH

Flexible reversible hat "Switch", with nylon on the outside and fleece on the inside

Packing: 50/300 pieces | Size: one size

Branding:

☰ 70x45mm T1



☞ Reversible
hat



56-0702035
black



56-0702037
blue

DRY AND SAVE 56-0609038

Poncho "Dry and save" with reflector stripes

Packing: 25 pieces | Size: 133x114 cm

 Reflects**KEEP DRY** 56-0603107

Bicycle poncho "Keep dry" with hood and drawstring around the face, in universal size

Packing: 25/50 pieces | Size: 131/93cm

Branding:

 300x300/85x85 mm S3+H6**AUTUMN**

Poncho "Autumn" with hood, in universal size

Packing: 200 pieces |

Size: 130x124cm

Branding:

 20x20mm K1+H3 Compact56-0603103
transparent56-0603106
blue



GUARD 56-0403122

Red safety back light "Guard" with neon yellow arm strap

Packing: 50/200 pieces |
Size: 7x4,5cm

Branding:

40x5mm K1+H2



AA/LR6/AM3



For your arm +
bicycle



SOUNDRIDER 56-0406230

Bicycle speaker "Soundrider": mono quality speaker, FM-radio, line-in connection 3,5mm plug, plays MP3 or WMA audio files, USB 2.0, integrated card reader for TF/micro SD cards, including earphones, integrated rechargeable battery, USB-battery charger leads, easy to install

Packing: 10/40 pieces | Size: 8,8x3,8cm |

Material: Aluminium

Branding:

35x11 mm K2+H6+V1

35x11 mm L2+H6

FM



BIKE AID 56-0381027

Bicycle bag "Bike Aid" with reflectors, Velcro attachments to connect it to the bike, bag with zip, consists of pump, tools and repair kit packed in a case, net pockets on the outside with an aluminium drinking bottle

Packing: 10/20 pieces | Size: 30x16x9,5cm

Branding:

50x25mm K1+H4+V1

90x40mm T2+H4

50x20mm L4+H4



AIRFLOW 56-0605101

Bicycle air pump "Airflow" with adaptors for standard bicycle valves, balls and inflatable toys. Includes 2 fasteners for bicycle frames

Packing: 100 pieces |

Size: Ø2,2x22-48 cm

Branding:

50x10mm K1+H2+V2

**SMART LIGHTS** 56-0699911

Torch set "Smart Lights" with 2 torches, one with red light and the other with white light, 2 light modes (steady light or flashing), rubber-coated ON/OFF button with elastic band to fasten on handles, packed in transparent box

Packing: 25/250 pieces |

Size: 5x3,5x1,5/9,5x4,5x2 cm

Branding:

40x10/20x20mm K1+H4+V1

2x
INCL.

2 light
modes

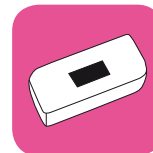
**DRY SEAT**

Bicycle seat cover "Dry Seat": suitable for a variety of bicycle saddles thanks to elastic band, waterresistant

Packing: 500/1000 pieces |

Size: 27x22x7 cm | Material: 190T Polyester

Branding:

70x70mm T1+H2



56-0402465
green



56-0402460
white



56-0402461
black



56-0402462
blue



56-0402463
red



56-0402464
orange



56-0402466
pink



56-0402467
yellow

PANORAMA 56-0699906

Power LED light "Panorama" with 9 strong LED lights, rubber-coated ON/OFF button, carrying handle and fixture

Packing: 50/100 pieces |

Size: Ø2,9x9,5/8,4x5,5x4,7 cm

Branding:

☰ 25x10mm K1+H4

✂ 70x20mm LR2+H4 360°

3x
EXCL.

AAA/LR03/AM4

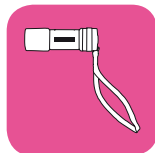
**DOWN HILL** 56-0407117

Smartphone holder "Down Hill" for a bicycle: retaining bracket with spread of approx. 10cm, adjustable swivel joint for optimal positioning, screw mount to install on the bicycle handlebar – suitable for most smartphones, packed in a gift box

Packing: 50 pieces |

Size: 12,2x7x8cm

Branding:

☰ 40x15mm K2+H5+V1



without decoration

DYNAMIC 56-0230300

Bicycle bag "Dynamic" with heavy duty material, divided in 2 bags with zip pocket, flap with Velcro, each bag with strap on the inside, carrying handle on the top and reflectors for traffic

Packing: 10 pieces | Size: approx. 87,5x32,5x9,5/36x32,5x9,5 cm |

Material: Chlorofibre

Branding:

☰ 220x100mm T2+H4

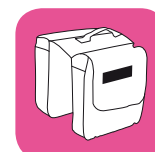

without decoration





BIKE 56-0230500

3 piece travel set "Bike", consists of a pair of pannier bags plus backpack, both bags with zip front pocket and reflector stripe, includes raincover for the set and an adjustable and detachable shoulder strap for the bike bag

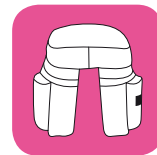

Packing: 10 pieces |

Size:

- 1 approx. 28x41x12 cm
- 2 approx. 31x41x12,5 cm |

Material: 600D Polyester

Branding:

☰ 80x80mm T1+H3

 Weatherproof



BIKE 56-0230501

Cooler bag "Bike" for the handlebar, zip main compartment for cooling, extra zip front pocket plus transparent pocket for a road map, includes raincover and an adjustable shoulder strap



Packing: 10 pieces |

Size: approx. 30x15x18 cm |

Material: 600D Polyester

Branding:

☰ 80x40mm T1+H2



 Weatherproof



ON TOUR 56-0381020

Practical stainless steel bike repair set "On Tour" packed in a handy pouch



Packing: 25 pieces | Size: 11x8,5x5cm |

Material: 600D Nylon

Branding:

☰ 35x25mm T1+H2



FELLOW

Armband "Fellow": adjustable neoprene armband thanks to Velcro fastener, see-through pocket with zip, suitable for wallet and smartphone – ideal for jogging, hiking, and walking

Packing: 50/250 pieces | **Size:** 16x41 cm | **Material:** Neoprene/PVC

Branding:

☰ 35x20mm K1+H2

☛ 20x35mm F1+H2

☷ 20x35mm T1+H2



56-0404407
blue



56-0404406
black



56-0404408
red



56-0404409
apple green



56-0404410
magenta



SPORTS

Wrist wallet "Sports": zip pocket, optimal for storing keys or MP3 player – ideal for jogging, walking, and hiking

Packing: 500 pieces | **Size:** 9,5x11 cm | **Material:** Polyester

Branding:

☛ 40x65mm F2+H2

☷ 40x65mm T1+H2



56-0702900
red



56-0702902
black



56-0702903
light green



56-0702904
blue



56-0702905
pink

TRENDY

Multifunctional headwear "Trendy" with at least 7 wear styles – provides protection against heat, cold, and wind

Packing: 150/300 piece | **Size:** 24,5x47 cm | **Material:** Polyester

Branding:

☛ 180x50mm F2+H2

☷ 180x50mm T2+H2

☷ 80x50mm T1+H2

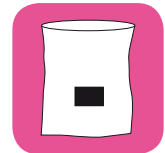

56-0702323
blue

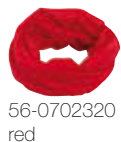

56-0702320
red

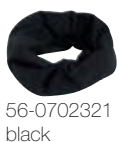

56-0702321
black



56-0702322
light green



56-0702324
light blue



56-0702325
pink

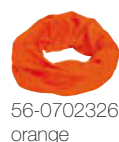

56-0702326
orange



56-0702327
grey



RUNNER 56-0403149

Shoe light "Runner": integrated light-band with 2 light modes (blinking and continuous light), with 2 white LED, on/off switch on the side – ideal for jogging, walking, and hiking

Packing: 100/400 pieces | Size: 9x6,4x3cm

Branding:

☞ 10x10mm K1+H2

2x
INCL.



NEW

2 light modes



without decoration

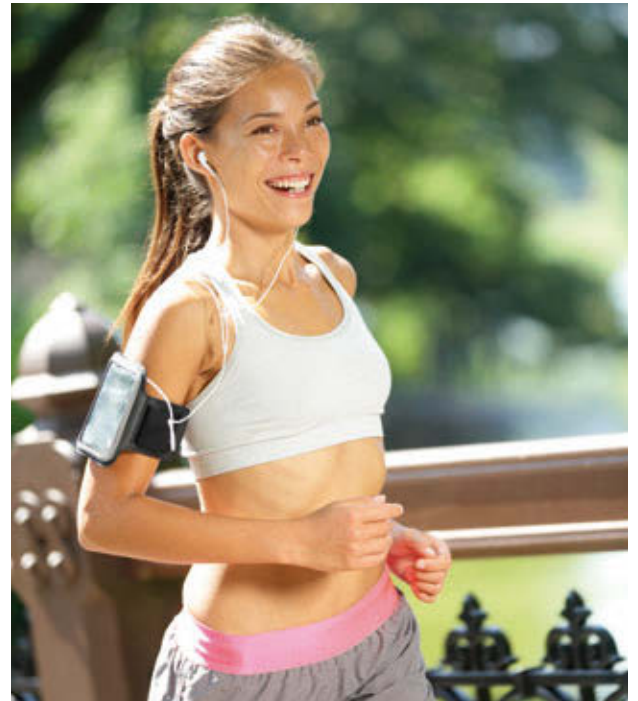

I'm on a roll.

**SEE ME**

Running belt "See Me", splash-proof: outside with opening for headphones and reflector for good visibility in traffic, inside with zip, adjustable and elastic belt with snap hook – ideal for jogging, walking, and hiking

Packing: 50/200 pieces | Size: 24x4,2cm

Branding:

☞ 80x15mm F1+H2

☞ 80x15mm T1+H2

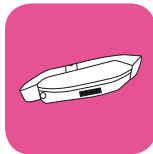

NEW

Reflects



without decoration

56-0404401
yellow/black



56-0404400
black

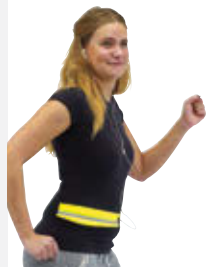

56-0404402
orange/black

**SMART RUN** 56-0404403

Mobile phone holder "Smart Run" for your arm, elastic band with Velcro fastening, transparent cover suitable for mobile phones and extra zip pocket, with reflector stripes

Packing: 50/250 pieces |

Size: 14x43,5cm

Branding:

☞ 40x10mm K2+H2+V1



Reflects



without decoration

You can find reflective items for athletic leisure time activities on pages 111-116.

OVERVIEW 56-0699987

Headlamp "Overview": 3 different light modes (strong, normal, and blinking light), on/off switch, range of light approx. 8 m, lamp with movable angle of inclination of up to 90 degrees as well as adjustable and elastic headband

Packing: 25/100 pieces | Size: 5,5x4x2,2 cm

Branding:

☰ 10x10mm K2+H4

✂ 20x5mm L1+H4



AAA/LR03/AM4



👉 3 light modes

**EXPEDITION** 56-0699992

Head lamp "Expedition" with 5 strong LED lights, light flashes or burns normally, ON/OFF button, adjustable light and adjustable nylon head band

Packing: 50/200 pieces | Size: 5,5x4x2,2 cm

Branding:

☰ 10x5/4x20mm K1+H4

✂ 10x5/4x20mm L4+H4



AAA/LR03/AM4

👉 For the evenings

**FIT AND FUN** 56-0606109

Extendable trekking sticks "Fit and fun" with a built-in compass in the handles, packed in a carrying bag

Packing: 20 sets | Size: 58-135 cm |

Material: Aluminium

Branding:

☰ 250x40mm T2+H3

✂ 30x10mm L2+H3

**MOUNTAIN** 56-0606114

Nordic walking sticks "Mountain", extendable, with compass and LED in the handle, plastic handles and feet, carrying loop, light weight aluminium sticks, include replacement feet, packed in a practical carrying bag

Packing: 20 sets | Size: 84 - 138 cm

Branding:

☰ 25x10mm K2+H5+V1

☰ 200x50mm T2+H5

✂ 6x60mm L2+H5



👉 With a light + compass



REBOOST

Sports water bottle "Reboost": lid with leak proof screw cap, drinking opening integrated in lid with secure pressure cap and flexible carrying handle, shock proof mug with measurements for volume in ml and oz., capacity approx. 750 ml

Packing: 36 pieces | Size: Ø8x23,5 cm

Branding:

☑ 30x15 mm K2+H2+V2

☑ 100x15 mm L5+H2

👉 approx. 750 ml



56-0304191
apple green



56-0304190
light blue

 NEW



56-0304192
magenta



REFRESHER

Drinking bottle "Refresher" with cooling function, removable cooling stick, integrated hanging loop in the lid, approx. 600 ml capacity

Packing: 56 pieces | Size: Ø6,8x26 cm

Branding:

☑ 20x30mm K2+H4

👉 Removable cooling stick



56-0304126
red



56-0304127
blue



PLAY TIME 56-0605007

Beach volleyball "Play time" made from synthetic leather, 2 layers with 18 panels, size 5

Packing: 50 pieces | Size: approx. Ø20 cm

Branding:

☰ 40x25 mm K2+H8

**PERFECT PLACE**

Comfortable cushion "Perfect place" - 3x foldable

Packing: 50/100 pieces | Size: 34x26 cm |

Material: 100% Polyester

Branding:

☰ 200x40 mm T2+H1

**ON TRACK**

Drinking bottle "On track" with decorative compass, removable cooling rod in the screw cap, and integrated shackle for hanging, capacity approx. 500 ml

Packing: 56 pieces | Size: Ø6,5x19,5 cm

Branding:

☰ 15x20 mm K2+H2+V2

☰ Approx. 500 ml



56-0304195
blue



56-0304196
red



56-0304197
orange



☰ Removable cooling stick



56-0304198
lilac



56-0304199
pink

KICK

Football "Kick" single-layered, with 32 segments, size 5, PVC in glossy effect

Packing: 50 pieces | Size: size 5 |
Material: 100% PVC

Branding:

 40x40mm K2+H8



56-0605024
silver



56-0605025
blue



56-0605026
red



56-0605027
orange

ARENA 56-0605017

Football "Arena" made out of synthetic leather, 2 layers with 32 segments

Packing: 50 pieces | Size: size 5

Branding:

 40x40mm K2+H8

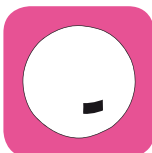
**AIRFLOW** 56-0605101

Bicycle air pump "Airflow" with adaptors for standard bicycle valves, balls and inflatable toys. Includes 2 fasteners for bicycle frames

Packing: 100 pieces | Size: Ø2,2x22-48cm

Branding:

 50x10mm K1+H2+V2

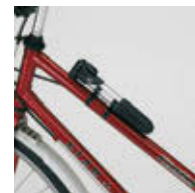
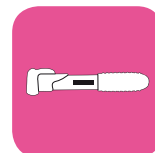

LOOPING

Promotional kite "Looping" with light weight fibreglass rods, cord handle and colourful tails

Packing: 250 pieces | Size: 70x58cm | Material: 190T Polyester

Branding:

☒ 220x200mm T2+H6



56-0606011
red

56-0606016
white

56-0606010
blue

CRAZY LOOP

56-0501058

Ring toss game "Crazy Loop" made of wood, in frog design, incl. 4 toss rings with wooden marks in different colours

Packing: 24/48 pieces | Size: Ø12x14,4 cm | Material: Wood

Branding:

☒ 70x20/20x5mm K2+H5

☒ 20x5mm L4+H5

☒ 80x20mm L5+H5

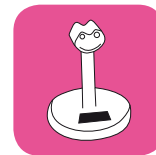

SCORE

56-0606112

Croquet set "Score": consists of 4 wooden mallets (length approx. 78cm), 4 coloured wooden balls, 10 hoops, and one start and finish peg each, in nylon carrying net

Packing: 10 sets | Size: 78 cm | Material: Wood

Branding:

☒ 30x10mm K2+H6

☒ 300x10/20x20mm L5+H6





BEACHLIFE 56-0606152

Sand bucket set "Beachlife", 7-pieces: consists of a small sand bucket with handle, 6 different molds, shovels, and rakes; buckets and contents vary in colour and shape, packed in a mesh bag

Packing: 90/180 pieces | Size: approx. 16x9 cm

Branding:

☑ 35x20mm K1

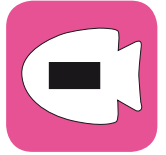

BEACHFUN 56-0606156

Beach toy "Beachfun": with sand mill, sand wheel, 1 rake, 2 shovels, and 1 sieve (colours vary), in mesh bag, with heart to print on

Packing: 70/140 pieces | Size: Ø10x16 cm

Branding:

☑ 50x30mm K1

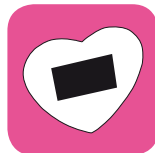

 **NEW**



For a nice day at the beach.



COOL DOWN 56-0406304

Water spray gun "Cool down" - works without battery: with transparent centerpiece, integrated pump for pressure buildup, push button to initiate the spray mechanism and supporting loop

Packing: 50/100 pieces | **Size:** Ø4,2x21 cm

Branding:

☞ 40x15mm K1+H4

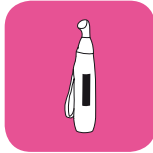

SWIRL

Hand-fan "Swirl" with neck cord - lateral on and off switch

Packing: 50/200 pieces | **Size:** 3x4x12cm

Branding:

☞ 15x20mm K1+H4

2x
EXCL.

AAA/LR03/AM4



56-0406312
orange



56-0406309
white

56-0406310
blue

56-0406311
red

56-0406313
green

NOTOS

Fan "Notos" with transparent blades, closure cap and on/off switch

Packing: 50/200 pieces |

Size: Ø3x9,9cm

Branding:

☞ 50x10/25x10mm K1+H2

☞ 50x10/25x10mm L4+H2



AAA/LR03/AM4



56-0406317
blue



56-0406318
red



56-0406316
white

CLASSIC 56-0603051

Sunglasses "Classic" with a modern form, 100% UV protection, dark glasses packed in a robust case

Packing: 50/150 pieces

Branding:

-  12x12mm K1+H5
-  50x30mm K1+H2+V1
-  12x12mm L5+H5
-  50x30mm L5+H2

**EYE-CATCHER** 56-0603050

Sunglasses "Eye-Catcher" with 100% UV protection, dark glasses and simple frame packed in a robust case

Packing: 50/150 pieces

Branding:

-  12x12mm K1+H5
-  50x30mm K1+H2+V1
-  12x12mm L5+H5
-  50x30mm L5+H2

**STYLISH**

Sunglasses "Stylish" with dark tinted glass, UV 400 certified, class 3 – suitable for strong sunlight, in high quality plastic frame, wide rims are a perfect place for your advertisement

Packing: 10/250 pieces | Size: one size

Branding:

-  20x5mm K1+H2+V1



56-0603054
blue



56-0603052
black



56-0603053
white



56-0603055
green



56-0603056
red



56-0603057
pink



56-0603058
yellow



56-0603059
orange

 UV 400 certified,
class 3

DAVID 56-0606100

Mini boule set "David" consists of 6 metal balls, wooden ball and a red measuring thread, packed in a black nylon bag with zip

Packing: 20 pieces | **Size:** 11x7x3 cm

Branding:

 60x20mm T1+H6

 10x10mm L2+H6



 Mini

**ANIMAL PLEASURE** 56-0606130

Water sprayers "Animal pleasure", animal heads are pulled out to put water in and pressed in to spray the water out, 4 times assorted

Packing: 48/192 pieces | **Size:** Ø3x29,8 cm

Branding:

 40x10mm K2+H2

**GOLIATH** 56-0606104

Boule set "Goliath": consists of 6 metal balls, wooden ball and a red measuring thread, packed in a black nylon bag with zip

Packing: 4 pieces | **Size:** 22,5x15x7,5 cm

Branding:

 210x135mm T2+H2



GAMBLE

Beach set "Gamble" with 2 elastic handles and 1 ball with suction cups

Packing: 100 pieces | Size: Ø18 cm

Branding:

☑ 60x18mm K1+H3+V2



56-0606151
orange/white

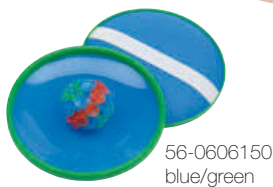

56-0606150
blue/green

SUN GUARD

56-0601050

Key ring "Sun guard" with UV tester and instruction manual, middle area changes colour and 4 smileys appear to indicate how strong the UV rays are

Packing: 1000/2000 pieces | Size: 3,6x9x0,2 cm

Branding:

☐ 25x25mm E1

☑ UV tester



FISHING

Telescopic scoop net "Fishing" with light expandable stainless steel rod and rubber-coated grip – ideal for catching insects, butterflies or fish

Packing: 25/100 pieces | Size: Ø20x38-86 cm

Branding:

☑ 30x5 mm K1+H2

☑ 20x4 mm L1+H2

☑ Extendable



56-0606153
blue



56-0606154
pink



56-0606155
green

SUMMER FEELING

Beach ball set "Summer feeling" with 2 wooden bats with coloured handles, 1 softball, packed in a net bag

Packing: 50 pieces | Size: 33,2x18,9x5 cm

Branding:

 45x30mm K2+H4

 70x30mm DP1+H4



56-0606137
pink/white



56-0606133
black/white



56-0606134
blue/white



56-0606135
green/white



56-0606136
orange/white





FLYING LEAP

Foldable flying disk "Flying leap" with approx. 25cm diameter when unfolded (folded approx. 8cm) with colour matching small bag

Packing: 50/500 pieces | Size: Ø25/9,5 cm | Material: 170T Polyester

Branding:

 40x40mm T1+H4

 Ø 150mm T2+H4

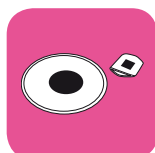

56-0606139
red

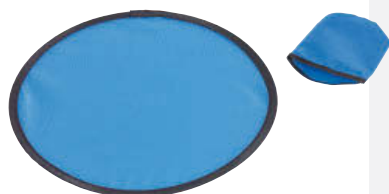

56-0606138
blue



56-0606140
white



56-0606141
orange

HAVE FUN

Beach ball set "Have fun" consists of 1 soft ball, 2 bats with plastic frame, elastic material on the inside

Packing: 30 pieces | Size: 18,9x33,2x5 cm

Branding:

 15x10mm K1+H4+V2

 70x70mm T1+H4

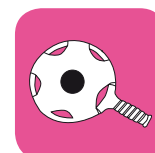

56-0606148
orange



56-0606149
blue

CLOUD

Shady beach shelter "Cloud" with fibreglass rods packed in a round bag

Packing: 10 pieces | Size: 190x100x106 cm

Branding:

 300x300/85x85 mm T2+H6



56-0603501
blue



56-0603507
orange



Beach day with my girls.

**SHIELD**

Pop-up beach shelter "Shield" – easy set-up and dismantling: comfortable lie down area and shady top, robust fibreglass rods with automatic set-up function, in round zip bag with 2 handles

Packing: 50 pieces | Size: 120x65/40x40 cm

Branding:

 200x200 mm F2+H6

 200x200 mm T2+H6

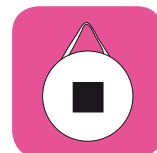

56-0602113
blue

56-0602115
green

56-0602114
orange

COAST

Beach mat "Coast": practical to roll in a pouch with zip and shoulder strap, made of water and dirt-resistant high quality synthetic weave

Packing: 50 pieces |
Size: 180x60/Ø7x60 cm

Branding:
☒ 300x150mm T2+H4

XXL
print



56-0602126
green



56-0602123
blue



56-0602124
red



56-0602125
yellow



56-0602127
orange



56-0602128
pink



56-0602129
lilac

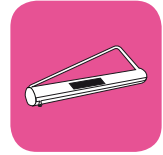

ALOHA

Sun and beach umbrella "Aloha": 2-piece metal shaft with swivel joint, metal ribs, plastic tips, polyester canopy, umbrella segments with wide flouces, colour-matching polyester carrying bag

Packing: 6/12 pieces | Size: Ø 160 cm | Material: Metal/Polyester

Branding:
☒ 65x140/350/200x340mm T2+H6
☒ 65x140/350/200x340mm S1+H6



56-0106010
white



56-0106012
red



56-0106011
blue



56-0106013
blue/white

BEACH SEASON 56-0602118

Inflatable mattress "Beach season" with one air chamber, 74x28 inch deflated

Packing: 24 pieces | Size: approx. 170x62x13 cm |
Material: 0,25 mm PVC

Branding:

 220x50/50x120mm T2+H6
Phthalate free

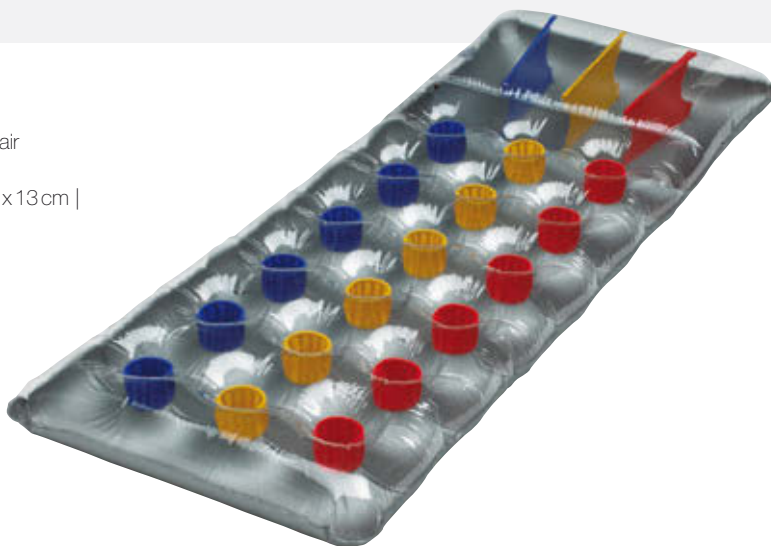
**CHILL + RELAX** 56-0602119

Inflatable mattress "Chill + relax" with 2 air chambers und 2 valves, extra pillow, drawstring around the outside to hold, lying space: approx. 158x82cm, max. 75kg, 82x52x8 inch deflated

Packing: 4 pieces |
Size: approx. 208x132x28 cm |
Material: 0,35 mm PVC

Branding:

 220x50mm T2+H9
Phthalate free

 Extra wide

**MARINA**

Maritime beach mat "Marina" with inflatable pillow, folds into a bag

Packing: 20 pieces | Size: 180x86,5cm

Branding:

 200x120mm T2+H6

56-0602121
red/white



56-0602100
blue/white



56-0602122
green/white

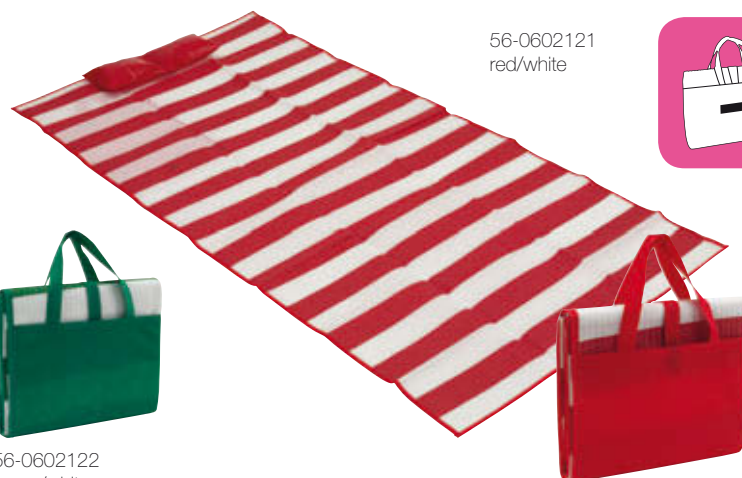

SEASIDE

Inflatable chair "Seaside" (max. 100 kg)

Packing: 25 pieces | Size: approx. 77x65x45 cm |
Material: 0,25mm PVC

Branding:

 210x170mm T2+H7

Phthalate free



56-0602311
white/transparent



56-0602206
blue/transparent



56-0602213
orange/transparent



ROXY

56-0602089

Inflatable dolphin "Roxy" with black handles,
74x31 inch deflated

Packing: 24 pieces |
Size: approx. 160x75x40 cm |
Material: 0,30mm PVC

Branding:

 100x70mm T2+H6

Phthalate free



DAISY

56-0602120

Inflatable shark "Daisy" with black handles, 68x31 inch
deflated

Packing: 24 pieces | Size: approx. 170x100x55 cm |
Material: 0,25mm PVC
Phthalate free



OVERBOARD

Inflatable swimming ring "Overboard" filled with foam beads, deflated approx. 27 inches

Packing: 50/100 pieces | Size: Ø64 cm |
Material: 0,17 mm PVC

Branding:

☰ 40x30mm K3+H4
☰ 200x60mm T2+H4
Phthalate free

56-0602323
turquoise

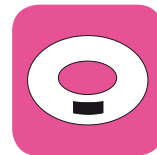

56-0602322
red



56-0602324
pink



Time to unwind.



SPLASH

Inflatable mini mattress "Splash": with oral inflation valve, see-through panel and 2 suspension hooks with separate tie (approx. 24 cm) – for a fun splash in the sea, at the beach, and in the pool

Packing: 50/100 pieces | Size: approx. 36x71 cm |
Material: 0,15mm PVC

Branding:

☰ 200x100mm F2+H2
☰ 200x100mm T2+H2
Phthalate free



56-0602138
white



56-0602139
blue



56-0602140
red



56-0602141
orange



INDIAN

Inflatable beach ball "Indian" in fresh frosted colours, 12" deflated

Packing: 100/500 pieces |

Size: approx. Ø22 cm | Material: 0,17mm PVC

Branding:

 40x30mm K3+H1

 120x60mm T2+H1

Phthalate free

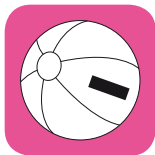

56-0602273
white



56-0602270
blue



The beach is waiting.



UNIVERSE 56-0602002

Inflatable beach ball "Universe" with globe design, 16" deflated

Packing: 100/200 pieces |

Size: approx. Ø28 cm | Material: 0,18mm PVC

Branding:

 40x30mm K3+H1

Phthalate free



 These articles are free of phthalates. Phthalates are sanitizers which may have a negative effect on your health.

GO FOR GOAL 56-0602209

Inflatable ball "Go for Goal" with football design, 18" deflated

Packing: 100/200 pieces |

Size: approx. Ø30 cm | Material: 0,17mm PVC

Branding:

 Ø30mm K3+H1

 50x50mm T1+H1

Phthalate free





ATLANTIC

Inflatable beach ball "Atlantic" with white and coloured panels, 16" deflated

Packing: 100/200 pieces | Size: approx. Ø28 cm | Material: 0,17mm PVC

Branding:

 40x30mm K3+H1
 150x60mm T2+H1
 Phthalate free

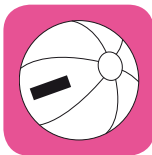

56-0602076
blue/white



56-0602077
red/white

PACIFIC

Inflatable beach ball "Pacific", 6 segments, 16" deflated

Packing: 100/200 pieces | Size: approx. Ø28 cm | Material: 0,17mm PVC

Branding:

 40x30mm K3+H1
 120x60mm T2+H1
 Phthalate free

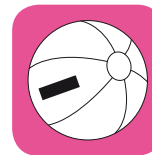

56-0602307
purple

56-0602303
pink

56-0602304
blue

56-0602306
white



56-0602308
turquoise

ATLANTIC

Inflatable beach ball "Atlantic" with white and shiny coloured segments, 16" deflated

Packing: 100/200 pieces | Size: approx. Ø28 cm | Material: 0,17 mm PVC

Branding:

 40x30mm K3+H1
 150x60mm T2+H1
 Phthalate free



56-0601991
turquoise/white



56-0602078
yellow/white

56-0602079
green/white

56-0602080
orange/white

56-0602081
pink/white

56-0601990
purple/white



FUN IN THE SUN

Inflatable hammer "Fun in the sun": deflated approx. 33 inches incl. hammer head – hammer makes squeaking noises when pressed

Packing: 100/200 pieces |
Size: 87x42x12 cm | Material: 0,15mm PVC

Branding:

-  70x25mm K3+H4
 -  120x30mm T2+H4
- Phthalate free



56-0602325
red

56-0602326
blue

 **Makes squeaking noises**

KNOCK OUT

56-0602220

Boxing gloves "Knock out", inflatable: the hand reaches from the bottom, including vent holes as well as a cord to tie up the gloves

Packing: 50 sets | Size: approx. 45x31x21 cm |
Material: 0,18mm PVC

Branding:

-  110x80mm T2+H2

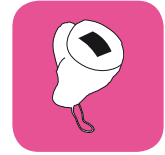

BEACHFIT

Beach noodle "Beachfit": with oral inflation valve, length approx. 130cm – ideal toy at the beach and lake

Packing: 100/200 pieces | Size: approx. Ø6x126cm |
Material: 0,15mm PVC

Branding:

-  70x20mm K1+H2
 -  300x60mm F2+H2
 -  300x60mm T2+H2
- Phthalate free



 **NEW**

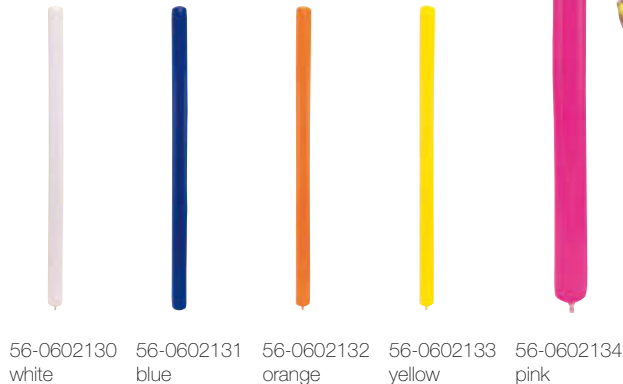

56-0602130
white

56-0602131
blue

56-0602132
orange

56-0602133
yellow

56-0602134
pink



SIMPLY MAGIC

Drinking bottle "Simply Magic": with screw cap, cover and carabiner - unfilled bottle can be folded to save space, capacity approx. 480ml

Packing: 100/400 pieces | **Size:** 23x14x3,5cm
23x15x3,5cm

Branding:

☑ 60x15/40x40mm K1+H3+V1
Phthalate free



👍 Can be folded to save space when unfilled



56-0603033 green 56-0603034 orange 56-0603035 blue 56-0603036 red 56-0603037 transparent

ICE CUBE 56-0606144

Transparent cooler bag "Ice cube" with handles, before use put the bag in the freezer so the transported bottle stays cool for longer, suitable for 1 litre bottles

Packing: 25/50 pieces | **Size:** 10x10x25cm

Branding:

☑ 40x20mm K2+H2
☑ 40x20mm T1+H2



👍 For one 1 litre bottle

SMART SPLASH

Phone pouch "Smart Splash", splash-proof: transparent front, frosted back side, with safety closure and Velcro closure, adjustable cord (length approx. 45 cm) with plastic stopper – ideal for beach and lake to stow smartphone, wallet, and other valuables

Packing: 500 pieces | **Size:** 22,5x9cm

Branding:

☑ 60x20/30x40mm K1+H2



56-0404905 magenta



👍 Splash-proof



56-0404900 black 56-0404901 white 56-0404902 blue 56-0404903 red 56-0404904 apple green 56-0404906 orange 56-0404907 yellow

CHAMPION 56-0505204

Mini kicker "Champion" with aluminium front and 2 metal footballs, packed in a gift box

Packing: 10/30 pieces | Size: 20,4x11,4x3cm |
Material: Metal

Branding:

🔪 50x10mm L2+H4

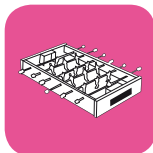
**GREAT SUCCESS** 56-0505057

Dice game set "Great Success" consists of 6 dice, 1 dice cup and 1 pad of paper, includes instructions, packed in a gift box

Packing: 50 pieces | Size: 17,5x11x5,7cm

Branding:

🔪 25x20mm K1

🔪 35x20mm K1+H3+V1

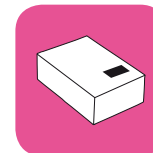
**FAMILY-FUN** 56-0501030

Game set "Family-fun" with chess, backgammon, checkers, domino, cards and dice games packed in an elegant wooden box

Packing: 20 pieces | Size: 20,8x20,8x5 cm |
Material: wood

Branding:

🔪 40x10mm K2+H3

🔪 65x8mm L4+H3



FLY AWAY 56-0503111

Helicopter "Fly Away": 1) Infrared remote control with approx. 10 m range, 3 different channels (A, B, C), LED control lamp for ON and OFF, 2 joysticks for steering (up, down, right, left, forwards, backwards), 2 buttons for trimming, 2 buttons to adjust speed and light 2) Helicopter has low own weight, on and off switch, LED lighting, integrated battery is recharged via charging cable of remote control, flight time: approx. 10 minutes – suitable for indoor flights

Packing: 10/20pieces | Size: 22x4x11,5 cm

Branding:

30x10mm K1+H4

20x10mm L4+H4

6x
EXCL.

AA/LR6/AM3



POKER 56-0505101

Poker game, consists of chips, cards and a turnable holder for the accessories

Packing: 5 pieces | Size: Ø19,5x12 cm

Branding:

20x15mm K2+H8



DOMINO 56-0501011

Classic game "Domino" packed in a wooden box with sliding lid, contains 28 dominos

Packing: 100 pieces | Size: 14,5x4,9x2,9cm | Material: Wood

Branding:

-  70x20mm K1+H2
-  70x20mm DP2+H2
-  100x20mm L4+H2

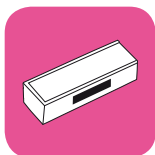
**HIGH-RISE** 56-0501036

Skill tower game "High-rise", made out of wood and packed in a gift box

Packing: 50 pieces | Size: 16x5x5cm | Material: Wood

Branding:

-  30x18mm K1+H1

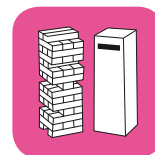
**FOCUS** 56-0501012

Mikado game "Focus" with 41 sticks packed in a wooden box with sliding lid

Packing: 100 pieces | Size: 19,5x4,5x3cm | Material: Wood

Branding:

-  70x20mm K1+H2
-  75x15mm DP1+H2
-  100x20mm L4+H2

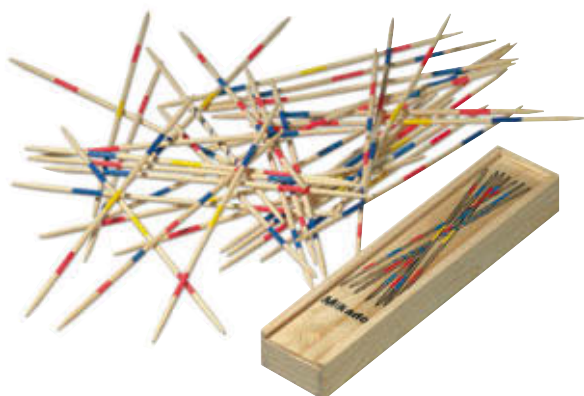
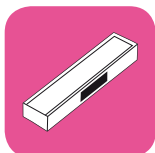

Take a break!



TRICKY TIGER 56-0501064

Patience game "Tricky Tiger" consists of a wooden tiger with black imprint, 24 wooden sticks in 4 different colours, instructions, packed in an environment-friendly cotton bag

Packing: 100/300 pieces |

Size: 8x5,2x1,6cm | Material: Wood

Branding:

☞ 40x40mm T1+H3



CRAZY CUBE 56-0501032

Dice puzzle "Crazy cube" made out of natural juniper wood packed in an environment-friendly cotton bag

Packing: 30/120 pieces |

Size: 4x4x4cm | Material: Wood

Branding:

☞ 50x50/60x10mm T1+H3

☞ 50x50/60x10mm S4+H3



TANGRAM 56-0501033

Puzzle "Tangram" made out of natural juniper wood packed in an environment-friendly cotton bag

Packing: 30/120 pieces |

Size: 14x7x0,9cm | Material: Wood

Branding:

☞ 50x50/60x10mm T1+H3

☞ 50x50/60x10mm S4+H3



CRAZY TOWER 56-0501063

Skill game "Crazy Tower" consists of a small semicircular ball, 6 figures and a dice, packed in an environment-friendly cotton bag

Packing: 100/200 pieces |

Size: 13,4x5,9cm | Material: Wood

Branding:

☞ 100x100mm T2+H3



CLEVER CONCEPTION 56-0505046

Tricky metal puzzle "Clever conception" with hooks, 4-times assorted

Packing: 100/500 pieces |
Size: approx. 6x4,5x1,5cm

Branding:

-  20x20mm K1+H4
-  60x45mm DP2+H2

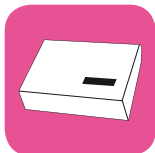
**THINK ABOUT** 56-0505063

Patience game "Think about" in metal box with a paper label, 5-times assorted

Packing: 50/300 pieces | Size: 9,6x6x2,1 cm

Branding:

-  40x15mm K1+H2+V2
-  90x50mm DP2+H2
-  40x15mm L1+H2

**UPSIDE DOWN** 56-0501044

Yoyo "Upside down" made out of natural wood

Packing: 100/300 pieces | Size: Ø5,3x2,8cm |
Material: Wood

Branding:

-  20x20mm K1+H2
-  20x20mm DP1+H2
-  Ø20mm L3+H2

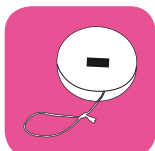
**LOST** 56-0501035

Wooden labyrinth game "Lost" with metal balls and 14 holes

Packing: 60/120 pieces | Size: 9x9x2,5cm |
Material: Wood

Branding:

-  60x15mm K1+H2



ANIMAL ANIMATION 56-0501049

Colourful skipping rope "Animal Animation" with different animal designs (elephant, monkey, zebra and giraffe) on the handles

Packing: 12/144 pieces | **Size:** 200 cm |
Material: Wood

Branding:
15x10mm K1+H2

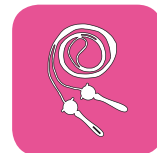

FUNNY ANIMALS 56-0501070

Wooden bookmarks "Funny Animals" 4-times assorted, with funny animal heads and ruler on the back of the bookmark

Packing: 120/480 pieces |
Size: 12,8x2,8cm | **Material:** Wood

Branding:
10x10/15x15 mm K1+H2

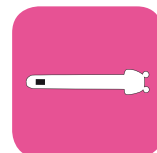

 Magnetic

FUNNY FOUR 56-0501071

Memo holder "Funny Four" with a magnet and 4 different animal motives

Packing: 100/500 pieces | **Size:** approx. 6,5x5,5 cm |
Material: Wood

Branding:
20x20mm K1+H2

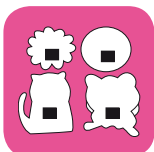

FLOWER POWER 56-0501076

Push puppets "Flower power", 4 assorted colours

Packing: 20/160 pieces | Size: Ø4,5x12,7 cm |

Material: Wood

Branding:

☰ 15x15mm K1+H2

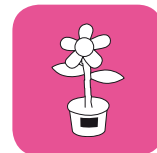

CRAZY CLOWNS 56-0501075

Push puppets "Crazy clowns", 3 assorted colours

Packing: 30/300 pieces | Size: Ø4,5x13 cm |

Material: Wood

Branding:

☰ 15x15mm K1+H2



NINI 56-0501059

Wooden mouse "Nini" with pullback motor, cotton string tail, felt ears and plastic wheels

Packing: 24/384 pieces | Size: 6x4x3,5 cm

Branding:

☰ 20x10mm K2+H2

☑ 20x10mm L4+H2



☑ With pullback motor

PASTIME 56-0407106

Handy squared puzzle
"Pastime"

Packing: 100/500 pieces |
Size: 9x7,5cm

Branding:

50x50mm K1+H2
54x54/90x75mm DP2+H2

**JUGGLE**

Anti-stress ball "Juggle"

Packing: 48/240 pieces | Size: Ø5 cm

Branding:

20x10mm K1+H2+V2



56-0402104
green/white



56-0402101
blue/white



56-0402102
red/white



56-0402103
yellow/white



56-0402108
light green/white



56-0402109
magenta/white

4 IN A LINE 56-0505039

Entertaining travel game "4 in a line" with yellow and red tokens packed in a gift box

Packing: 25/100 pieces |
Size: 10,3x14,3x3,3 cm

Branding:

70x25mm K1+H2+V1

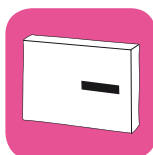
**TRICKY THING** 56-0505040

Patience games "Tricky thing": 24 assorted cubes with colourful inner games

Packing: 24/240 pieces/assorted |
Size: 4x4x4 cm

Branding:

15x15mm K1+H2

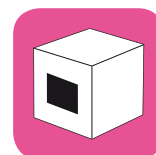

PIGGY 56-0402117

Anti-stress pig "Piggy"

Packing: 50/200 pieces | Size: 8x6,5x7 cm**Branding:**
☑ 30x10mm K2+H2+V1**AMOR** 56-0402118

Anti-stress heart "Amor"

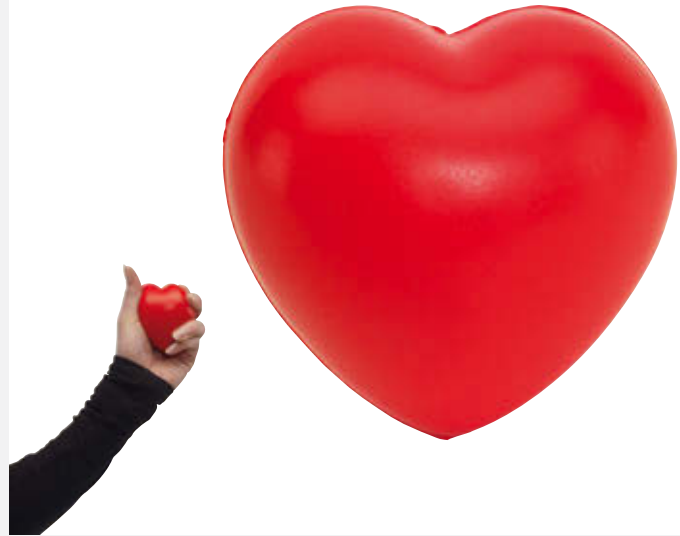
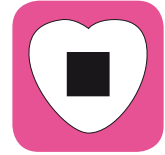
Packing: 50/150 pieces | Size: 8x7,5x6 cm**Branding:**
☑ 10x10mm K2+H2+V1**GLOBUS** 56-0506004

Anti-stress softball "Globus"

Packing: 50/250 pieces | Size: Ø6,2 cm**Branding:**
☑ 30x10mm K2+H1+V1**SOFT** 56-0402115

Anti-stress dice "Soft"

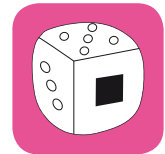
Packing: 50/250 pieces | Size: 5,5x5,5x5,5 cm**Branding:**
☑ 25x25mm K2+H1+V1

KICK OFF 56-0402127

Anti-stress football "Kick off"

Packing: 125/250 pieces | Size: Ø7 cm

Branding:

☺ 12x12mm K2+H2+V1

**TAKE OFF** 56-0402111

Anti-stress aeroplane "Take Off"

Packing: 50/250 pieces | Size: 8,5x9x4 cm

Branding:

☺ 10x6/15x10mm K2+H2+V1

**COLOUR UP** 56-0402128

Anti-stress ball "Colour up"

Packing: 50/200 pieces | Size: Ø6,3 cm

Branding:

☺ 15x20/20x20mm K2+H2+V1



COLOURED CURLY 56-0504103

Rubber bands set "Coloured Curly" consists of 300 bands, 12 S-shaped plastic clips and 1 plastic hook needle – for braiding or weaving e.g. bracelets, necklaces, hair bands, and shapes of chosen length, latex free

Packing: 360 sets

Branding:

40x30mm E1+H2



SKY HOPPER 56-0501055

4 piece aeroplane "Sky hopper" for building together, consists of plastic slingshot with elastic band, 3 pieces from foamed rubber, packed in PVC bag

Packing: 360 pieces | Size: 13x4,5 cm

Branding:

40x20mm E1+H6



JOE 56-0605020

Jumping ball "Joe" with approx. 50,5cm diameter, handles and printed face, packed in a gift box

Packing: 12 pieces | Size: Ø50,5 cm

Branding:

40x20mm E1

80x40mm E3



AIR BUBBLE 56-0503022

Soap bubbles "Air bubble" with patience game on the lid, 4 colours assorted

Packing: 24/288 pieces | Size: 9xØ3,5 cm

Branding:

☰ 15x12mm K1+H2

**CHAMELEON** 56-0505085

Magic ball "Chameleon" with 2 colours: black/green and blue/orange

Packing: 50/100 pieces/assorted | Size: Ø9,5 cm

Branding:

☰ 10x10mm K1+H6

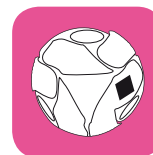

👉 Changes the colours when thrown up into the air

ACROSS THE BALL 56-0505086

Ball set "Across the ball": 100 balls in net bag, suitable for ball pool

Packing: 5 sets | Size: Ø6 cm

Branding:

☰ 35x10mm K1

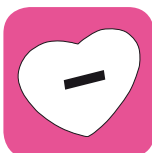

SELECTION 56-0505058

Mini puzzle "Selection" 24 different puzzles with 24 puzzle pieces

Packing: 24/240 pieces |
Size: 9,2x6,5x2,7 cm

Branding:
☺ 50x15mm K1+H2

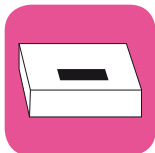
**FUNNY ACTIVITY** 56-0504100

Modelling clay "Funny Activity", includes 16 different coloured clay sticks, 2 shape cutters and 4 tools (colours and forms vary for the cutters and tools), packed in a case with a carrying handle

Packing: 20 sets | Size: 16x10x8 cm

Branding:
☺ 40x15mm K2+H3+V1

**AVENUE** 56-0504000

15 pieces of street chalk "Avenue" packed in a square bucket

Packing: 24 sets | Size: 14x12x8,7 cm

Branding:
☺ 50x10mm K1+H2



☺ 15 different colours

**STREET** 56-0504006

6 pieces of coloured chalk "Street" packed in a gift box

Packing: 12/72 sets | Size: Ø2,5x11 cm

Branding:
☺ 40x40mm K1+V1
☒ 40x40mm DP1+H2

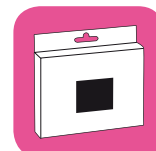

☺ 6 different colours





ROLL UP 56-0504069

Tape dispenser "Roll Up": 4 different colours, 8 different motifs, 24 times assorted, in plastic case with safety cap – ideal for doing arts and crafts with children

Packing: 24/432 pieces | **Size:** 7x2,5x1,5 cm |
Material: ABS

Branding:

-  10x8mm K1+H2
-  20x10mm DP1+H2
-  8x15mm E1+H2

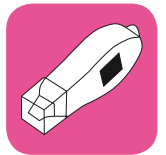

 8 different designs

**HEART CUT** 56-0504102

Heart-shaped paper punch "Heart Cut" with key ring

Packing: 200 pieces |
Size: 3,5x2,7x3 cm

Branding:

-  10x8mm K2+H2

**FANCY** 56-0504101

Stamp set "Fancy": consists of 5 wooden stamps with various patterns, 1 ink pad in 4 basic colours with lid, in paper box

Packing: 120/240 pieces |
Size: 6,2x6,2x2,5 cm

Branding:

-  30x10mm K1+H2
-  40x40mm E2+H2



COLOUR BALANCE 56-0504074

20 black painted coloured pencils "Colour balance" sharpened, packed in a metal tin with a sharpener in the lid

Packing: 25/50 pieces | **Size:** 20xØ4 cm | **Material:** Metal

Branding:

- 📏 50x15mm K1+H2+V2
- ✂️ 100x100mm LR2+H2 360°
- ✂️ 20x16mm L1+H2

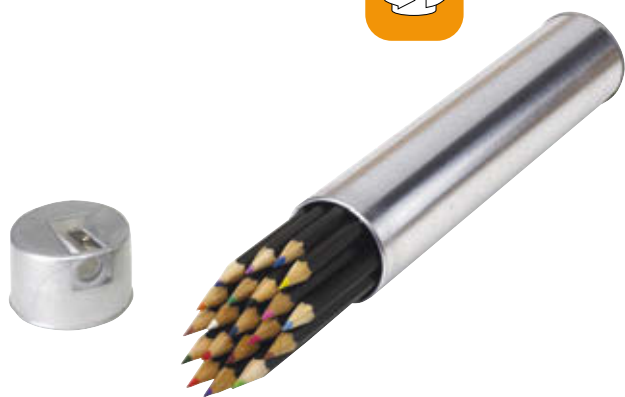
**SILVERSTAR** 56-0504085

12 long coloured pencils "Silverstar", silver-coated, sharpened, packed in rectangular metal box

Packing: 10/100 pieces | **Size:** 18,5x10,2x1 cm | **Material:** Metal

Branding:

- 📏 70x25mm K1+H2+V2
- 📏 170x90mm DP2+H2
- ✂️ 35x15mm L1+H2

**COLOURFUL** 56-0504095

Jumbo coloured pencils "Colourful" with 6 non-coated pencils, sharpened, packed in gift box

Packing: 30/120 pieces | **Size:** 18,2x8,2x1,5 cm

Branding:

- 📏 20x20/Ø20mm K1



NATURAL COLOUR 56-0504049

6 short coloured pencils "Natural Colour" made out of natural wood, sharpened, packed in a triangular box

Packing: 50/500 pieces | **Size:** 3x3x3x9 cm

Branding:

 40x10mm K1

**POINTED** 56-0504098

Pencil set "Pointed", 5 pieces: consists of 4 long sharpened natural wood pencils, with pencil sharpener made out of wood, in a round box

Packing: 50/400 sets |

Size: Ø2,8x21 cm

Branding:

 55x12 mm K2

 55x10mm DP1+H2



I'm excited about school!   

BEING BUSY 56-0504083

Pencil set "Being Busy", consists of a colouring book with pictures to colour in, 10 small colouring pencils, sharpened, 15cm ruler and a sharpener

Packing: 50/200 pieces |

Size: 18x7,5x1,2 cm

Branding:

 30x15mm K1

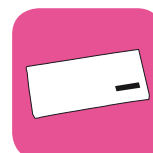

ART 56-0504037

14 piece colouring set "Art", consists of 6 coloured pencils, 6 wax crayons, eraser and sharpener packed in a box

Packing: 100/200 pieces | Size: 14x10x3cm

Branding:

 37x37/50x10mm K1

 70x50mm DP2+H2

**ART** 56-0504038

85 piece colouring set "Art" with coloured pencils, wax crayons, felt tip pens and more

Packing: 20 pieces | Size: 53,5x17x4,5cm

Branding:

 250x85mm S4+H1

**MONET** 56-0504067

88 piece art colouring set "Monet" packed in a wooden case with metal buckles and a handle

Packing: 10 pieces | Size: 43x26x5cm |

Material: Wood

Branding:

 70x25mm K2+H2

 35x12mm L5+H2



PICTURE-PERFECT 56-0504097

Painting set "Picture-perfect", 19 pieces: consists of 10 sharpened natural wood colouring pencils and 9 wax crayons in different colours, packed in a box with a see-through window

Packing: 50/200 sets | Size: 18x7,5x1,2cm

Branding:

 30x15mm K1

**STRAIGHT** 56-0504076

8 coloured pencils "Straight", sharpened, made out of natural wood packed in a wooden box with a ruler as a lid

Packing: 10/100 pieces |

Size: 20,5x4,2x2,3cm

Branding:

 70x15mm K1+H2

 70x15mm DP1+H2

 100x15mm L3+H2

**CREATIVE COLOUR** 56-0504068

Painting set "Creative colour": consisting of 12 water-based paints, 8 wax crayons and 1 brush, 1 pencil, 1 sharpener, 1 eraser, in a wooden box

Packing: 15/30 pieces | Size: 15,6x11,6x2,9cm

Branding:

 60x30mm K2+H2

 150x100mm DP2+H2

 30x15mm L5+H2



AGILE

Flexible pencil "Agile" not sharpened, with eraser

Packing: 50/1000 pieces | Size: 35 cm

Branding:

☰ 50x4 mm K1+H1+V1



👍 Flexible



56-1102312
pink

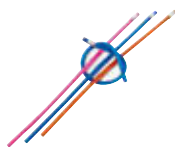

56-1102310
orange



56-1102311
blue

WATERWORLD 56-0504082

10 piece pencil set "Waterworld" shiny coated, not sharpened, with fish erasers

Packing: 50/100 sets | Size: 17,8 cm

Branding:

☐ 80x40 mm E3

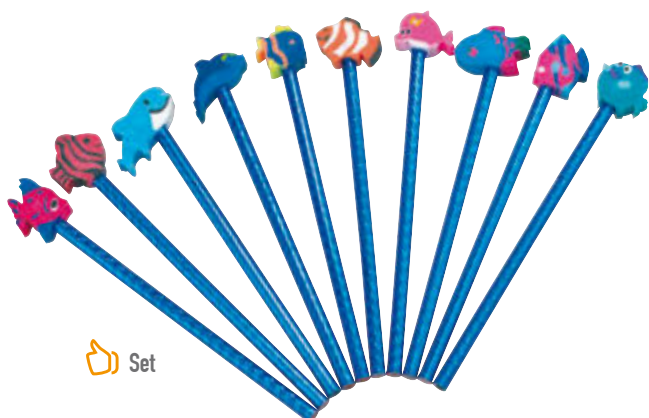

👍 Set

IMAGINE 56-0504008

8 wax crayons "Imagine" packed in a gift box

Packing: 120/240 pieces | Size: 9 cm

Branding:

☰ 35x8 mm K1

☰ 35x10 mm DP1+H2

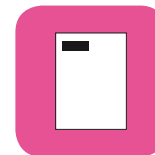
**CROCODILE** 56-0504099

Painting set "Crocodile": consists of 4 felt-tip pens in different colours and soft toy to colour, packed in PVC bag with handles

Packing: 50 pieces | Size: 15x8x11 cm

Branding:

☰ 50x10 mm K1+H5+V1



👍 Washable soft toy



PAINT YOUR PICTURE 56-0504091

Children's puzzle "Paint your picture", consists of 4 different puzzles (to colour in) and 4 felt tip pens, packed in OPP bag

Packing: 100 pieces | **Size:** 17,8x17,8cm

Branding:

□ 50x30mm E1



CRAZY ANIMALS 56-0504096

Colouring set "Crazy Animals" with 12 colouring pages with different motives to colour in, 8 coloured pencils sharpened, in transparent box

Packing: 40/200 pieces |

Size: 14,7x10,2x1,2cm

Branding:

ME 40x40mm K1+H2+V1

ME 120x80mm DP2+H2

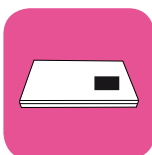

RAINBOW 56-0504090

Set of 6 coloured pencils "Rainbow", sharpened, packed in a colourful box, assorted 4 colours

Packing: 100/400 pieces | **Size:** 9x4,5x0,9cm

Branding:

ME 25x35mm K1+V1

ME 25x35mm DP1+H2

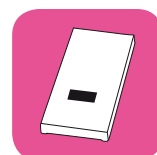

COOL RUN

Pencil case "Cool run" in form of a sneaker shoe: with zipper and laces to open and close

Packing: 60 pieces | Size: 24,5x8,5x12 cm

Branding:

 40x30mm T1+H2

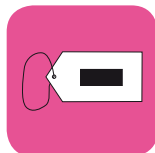

56-0503994
blue

56-0503995
rose

TINY TREE 56-0504040

6 short coloured pencils "Tiny tree" made out of natural wood, sharpened

Packing: 36/360 pieces | Size: 9x4,5x0,8 cm

Branding:

 30x10mm K1

 30x20mm DP1+H2



SMALL IDEA

Pencil Case "Small Idea": incl. 12 coloured pencils, sharpened – case with smooth-running zip and snap hook

Packing: 100/400 pieces |

Size: 10x3,5x3,5 cm

Branding:

 35x10mm T1+H3

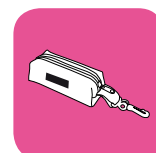

56-0503998
pink



56-0503996
orange



56-0503997
green



56-0503999
lilac

LUCKY 56-0502209

Plush pig "Lucky" with key ring, moveable limbs and clover for imprint

Packing: 200 pieces |

Size: approx. 4x3,5 cm

Branding:

☑ 10x10mm K1

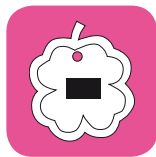
**SCHOOL**

Round pencil case "School" with a zip and a handle

Packing: 50/100 pieces | Size: 20xØ7,8 cm |

Material: 600D Polyester

Branding:

☑ 80x60mm T1+H1



56-1101781
blue



56-1101776
red



56-1101777
apple green



56-1101778
yellow



56-1101779
magenta

LARA, HURLEY + FELIX

Plush pencil case with a zip on the back, soft fur and a heart for printing

Packing: 200 pieces |

Size: approx. 30x9,5x6,5 cm

Branding:

☑ 35x10mm K1



56-0502181
mouse "Lara"

56-0502182
duck "Hurley"

56-0502183
bear "Felix"



without decoration

PAUL 56-0502164

Plush rabbit "Paul": with a printable scarf, scarf packed separately

Packing: 200 pieces |
Size: approx. 15cm

Branding:
☞ 40x12mm T1+H3

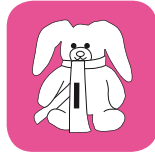
**LEEVI** 56-0502240

Plush hand puppet "Leevi" with soft fur, lined inside with cotton – easy for hand to slip in to move head and arms

Packing: 60 pieces | Size: approx. 27,5x17x12 cm

Branding:
☞ 35x10mm K1

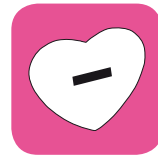
**RENÉ**

Cuddle set "René": consists of plush teddy bear with Velcro in paws and fleece blanket

Packing: 50 pieces | Size: approx. 18cm

Branding:
☞ 35x10mm K1

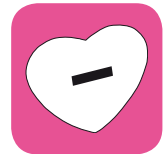

56-0502231
brown/violett



56-0502232
brown/blue



JONNY 56-0502244

Plush horse "Jonny": standing, with soft fur and red scarf (packed separately) to print on

Packing: 100 pieces | Size: approx. 23cm

Branding:

🔪 25x10mm F1+H3

🔪 25x10mm T1+H3

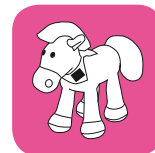

NEPOMUK 56-0502241

Plush crocodile "Nepomuk": with soft fur and scarf (packed separately) to print on

Packing: 100 pieces |

Size: approx. 30x16x5,5cm

Branding:

🔪 100x15mm F2+H3

🔪 100x15mm T1+H3



JUMPER 56-0502242

Plush kangaroo "Jumper": with soft fur, pouch and neckerchief (packed separately) to print on

Packing: 100 pieces | Size: approx. 18cm

Branding:

🔪 30x10mm F1+H3

🔪 30x10mm T1+H3



👉 With belly pouch

without decoration

LORENZO 56-0502077

Plush zebra "Lorenzo" with soft fur and with a printable heart attached

Packing: 100 pieces |

Size: approx. 30x12x10cm

Branding:

☺ 35x10mm K1

**MAURICE** 56-0502160

Super cuddly plush giraffe "Maurice" with a printable heart attached

Packing: 200 pieces |

Size: approx. 9x27cm

Branding:

☺ 35x10mm K1

**INGO** 56-0502079

Plush monkey "Ingo" with soft fur and a T-shirt (packed separately) for printing

Packing: 80 pieces |

Size: approx. 23x17x15cm

Branding:

☺ 50x50mm T1+H3



GRACE 56-0502177

Teddy "Grace" with a printable neck scarf, scarf packed separately

Packing: 100 pieces | Size: approx. 17 cm

Branding:

☞ 60x20mm T1+H2

**ALEXANDER** 56-0502243

Plush teddy bear "Alexander": in sitting position, with soft fur and white t-shirt (packed separately) to print on

Packing: 100 pieces | Size: approx. 18x27 xcm

Branding:

☞ 50x30mm F1+H3

☞ 50x30mm T1+H3



 **NEW**

**FETZY** 56-0502078

Plush lion "Fetzy" with soft fur and with a printable heart attached

Packing: 100 pieces |
Size: approx. 27x13x10cm

Branding:

☞ 35x10mm K1



ROSI 56-0502235

Plush sheep "Rosi": with soft fur and light blue scarf (packed separately) for printing

Packing: 100 pieces | Size: approx. 18 cm

Branding:

 20x10mm T1+H4

**BERND** 56-0502234

Plush frog "Bernd": with soft fur and yellow scarf (packed separately) for printing

Packing: 100 pieces | Size: approx. 18 cm

Branding:

 20x10mm T1+H4

**FRED** 56-0502193

Plush frog "Fred": with soft fur and dungarees (packed separately) for imprinting

Packing: 50 pieces | Size: 20x18,2x13cm

Branding:

 40x25mm T1+H3

**FRIEDA** 56-0502199

Plush frog "Frieda" with soft fur and white T-shirt (packed separately) for printing

Packing: 100 pieces | Size: approx. 18x27 cm

Branding:

 40x25mm T1+H3





MINNA 56-0502226

Plush bunny "Minna" with soft fur and green scarf (packed separately) for printing

Packing: 100 pieces |

Size: approx. 18 cm

Branding:

 20x10mm T1+H4



TUBBS 56-0502227

Plush bear "Tubbs" with soft fur and red scarf (packed separately) for printing

Packing: 100 pieces |

Size: approx. 18 cm

Branding:

 20x10mm T1+H4



VAGABOND 56-0502225

Plush dog "Vagabond" with soft fur and a blue scarf (packed separately) for printing

Packing: 100 pieces |

Size: approx. 18 cm

Branding:

 20x10mm T1+H4



BEATE, BEN, BILLY

Plush toys "Ben, Billy, Beate": with soft and multi-coloured fur – without print suitable for children under 3 years, with heart to print on

Packing: 100 pieces | **Size:** approx. 19,5x11x20cm

Branding:

 35x10mm K1

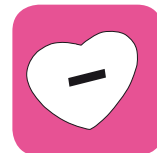

56-0502246
Billy



56-0502247
Beate



56-0502245
Ben

LARS 56-0502206

Plush bear "Lars" with soft fur and scarf for imprint (packed separately)

Packing: 100 pieces |
Size: 10,5x22x24 cm

Branding:

 30x25mm T1+H6



FRIDOLIN 56-0502207

Plush elk "Fridolin" with soft fur and triangle scarf for imprint (packed separately), in lying position

Packing: 100 pieces | **Size:** 11x22x21 cm

Branding:

 20x15mm T1+H6



LUNA 56-0502233

Comfort Blanket "Luna": consists of different cloth pieces and crackling film – to feel, see, and hear, without print suitable for children under 3 years

Packing: 100/200 pieces |

Size: approx. 23x23 cm

Branding:

♣ 40x25mm N1



 With rustling foil

**KIM** 56-0502205

Cuddly bear "Kim" without imprint suitable for children under 3 years, label attached for printing

Packing: 100 pieces | Size: approx. 57x50 cm

Branding:

♣ 40x25mm N1

**OLE** 56-0502196

Snuggle bunny "Ole": without imprint suitable for children under 3 years, with label for imprinting

Packing: 100 pieces | Size: approx. 37x23 cm



ELFRIEDE 56-0502228

Giraffe "Elfriede" suitable for children under 3 years: for looking at, touching and listening - the giraffe has long moveable limbs with various fillings (such as bells, crackling foil and squeaking noise) washable at 30° with heart for imprint

Packing: 50 pieces | Size: approx. 7x18x31 cm

Branding:

 35x10mm K1

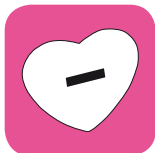
**JONAS** 56-0502180

Plush teddy "Jonas" with soft fur and a label for printing

Packing: 200 pieces | Size: approx. 22x10,5x5 cm

Branding:

 30x10mm T1+H2

**DOGGIE** 56-0502197

Plush hot bottle "Doggie", plush dog with Velcro closing on the back, red hot water bottle on the inside, hanging loop on the head and heart for imprint

Packing: 50 pieces | Size: approx. 30x27 cm

Branding:

 35x10mm K1

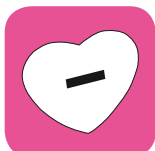

 600 ml



PICOWORLD '16

IDEAS FOR EXCELLENCE

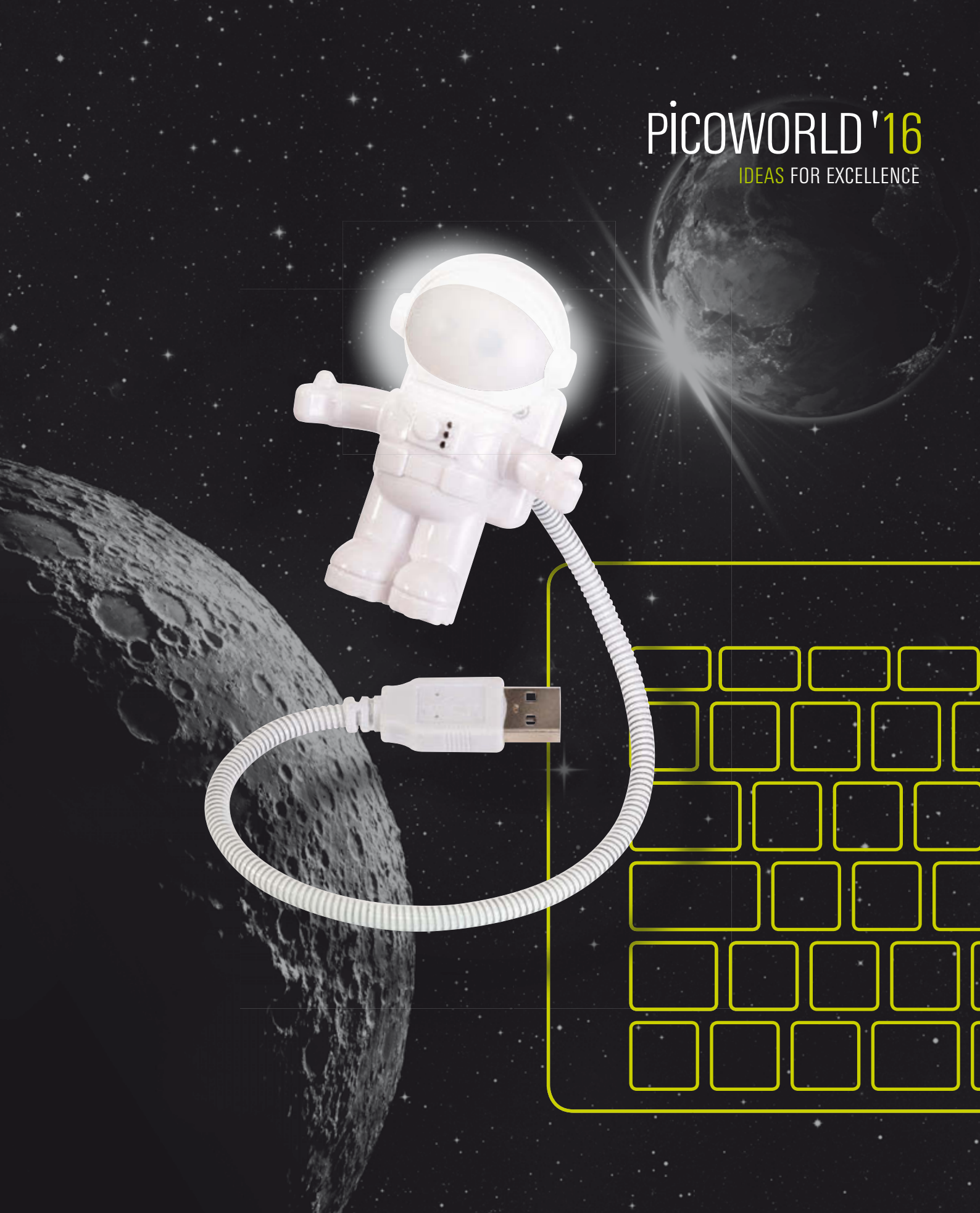

WELCOME

... to the PiCOWORLD 2016.

For those of us at PiCOWORLD, a promotional gift is more than a useful object which can be branded with a logo or slogan. It has to be unique!

An advertising item is the perfect medium to get sympathy points by a small gesture of giving. With our PiCOWORLD products you can either strengthen your customer relations or acquire new customers. A personal present expresses appreciation and solidarity, which is sometimes difficult to express in words.

For that reason, we are never satisfied with simple everyday objects in our search for new ideas. The result: carefully selected products that are characterized by individuality. High-quality innovations at good prices!

In order to do justice to the high demands we place on PiCOWORLD products, we have no limits on creativity – ours or yours! We make custom-made designs available to you at any time. Just tell us what your desired item should look like and we will take care of it.

First-class service is just as important to us as first-class promotional gifts. Just take a look at our picoservice tips regarding your order.

Dive in to our PiCOWORLD 2016 and let us surprise you.

„Enjoy!“

Your PiCOWORLD Team

PiCOWORLD '16



 **picopen**
Pens



408

 **picooffice**
Office accessories,
computer equipment
and powerbanks



426

 **picotime**
Clocks and
weather stations



452

 **picosound**
Radios, speakers
and headphones



462

 **picolux**
Lamps
and torches



470

 **picoflame**
Lighters



478

 **picoactive**
Outdoor and tools



 **picotravel**
Travel accessories

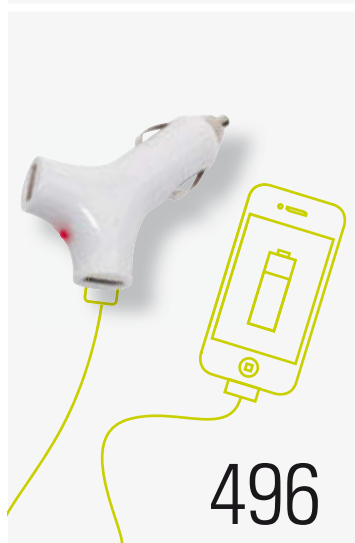

 **picostyle**
Key rings

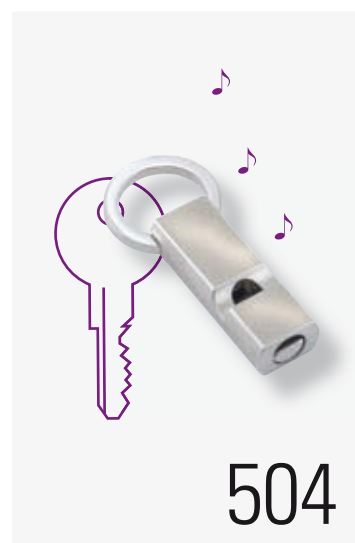

 **picohome**
Household and wine accessories



 **picogame**
Games



IDEAS FOR EXCELLENCE

Write away For all indescribable moments!

In the age of e-mails and WhatsApp a hand written letter is a bit out of fashion. Nevertheless, nothing is more enjoyable than closing a successful contract with own handwritten signature. Whether it is a ballpoint pen, a fountain pen, or a rollerball pen - it can tell you a lot about its owner. In a critical moment, you should therefore choose a writing instrument that you can rely on.

We pay great attention to create sparkling personality for our picopens, so you and your customers could stand out while leaving a mark. Let yourself be charmed by our complimentary pens!





Clip in PiCOWORLD design



58-8113001 white/silver
58-8113002 black/silver

highlight

TOUCH DOWN Stainless steel pen TOUCH DOWN: with high-capacity refill and twist mechanism, touchscreen point at the end of the shaft, in piano lacquer look with silver decorative elements, clip in PiCOWORLD design, black ink, packed in a gift box.

Packing: 200 pcs. /50 pcs. | Size: 13,75x1,4 cm | Branding:  30x7 mm K1+H2+V2 |  15x4 mm L1+H2



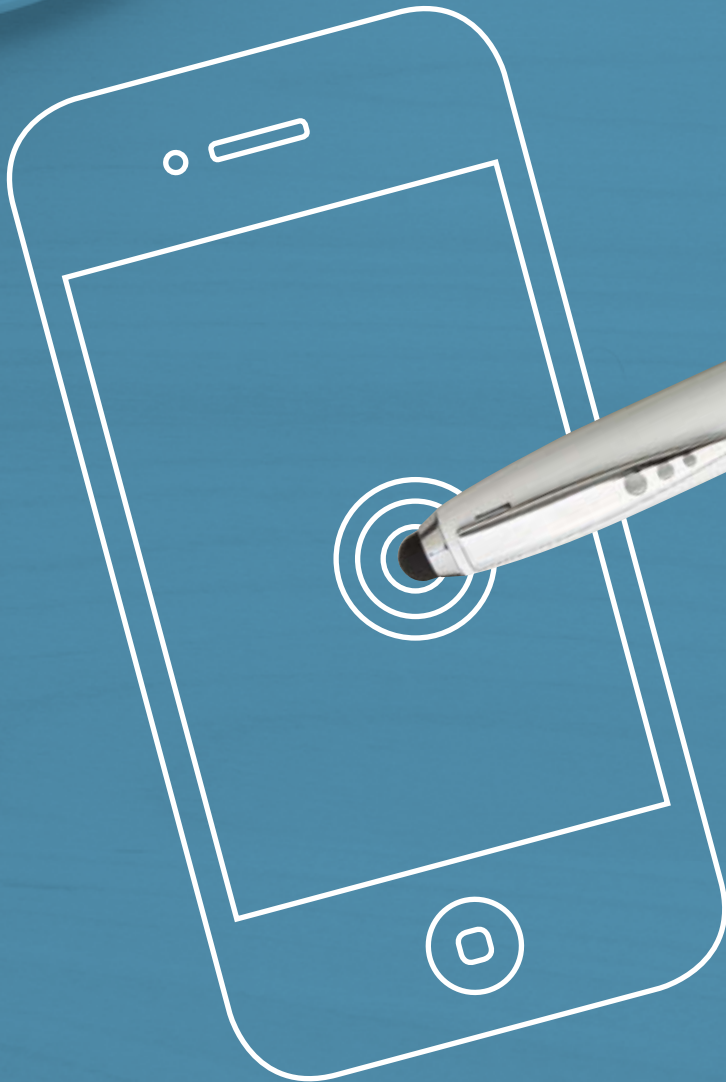

picopen

A nature-boy conquers the digital age.



With PDA touch-screen tip





With touchscreen point



without decoration

FINESSE 58-1100517 Metal ballpoint pen FINESSE: equipped with PDA tip, twist mechanism, blue ink, made of satin finish metal with polished chrome elements.

Packing: 200 pcs./50 pcs. | Size: 18,2x4x2,3/13x1,1 cm |
Branding:  40x5mm K2+H5+V1 |  40x5mm L2+H4



BAMBOO TOUCH 58-8110001 Ballpoint pen BAMBOO TOUCH: with spring mechanism, high-capacity refill, elegant bamboo shaft and touchscreen tip – suitable for tablet PCs etc. – blue ink.

Packing: 500 pcs./50 pcs. | Size: 14x1,2cm | Branding:  30x5mm K2+H4+V3

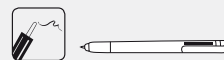



FLOATING PEN 58-1100377 Metal ballpoint pen FLOATING PEN with matching stand: twist ballpoint pen with blue ink, solid zinc stand - keeps pen floating through magnet.



Packing: 50 pcs. / 10 pcs. | Size: 12x2 x cm / Ø5,5x2,5 cm |

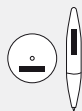

Branding:  20x8/10x4 mm L2+H6



ARCHITECT 58-1100407 Writing set ARCHITECT: consists of 10 cm long special ruler (triangle shaped, 1:125m / 1:100m / 1:75m / 1:50m / 1:20m) and twist action ballpoint pen (blue ink), with non-slip grip and integrated spirit level, comes in zip box with metal surface.

Packing: 100 pcs. / 10 pcs. | Size: 17x5,5x2,9 / 13,5x1,1 cm |

Branding:  30 x 2 mm K2+H5+V2 |  50 x 20 mm K2+H2+V1 |

 150 x 40 mm DP2+H2 |  30x2 mm L2+H5 |  50x20 mm L2+H2



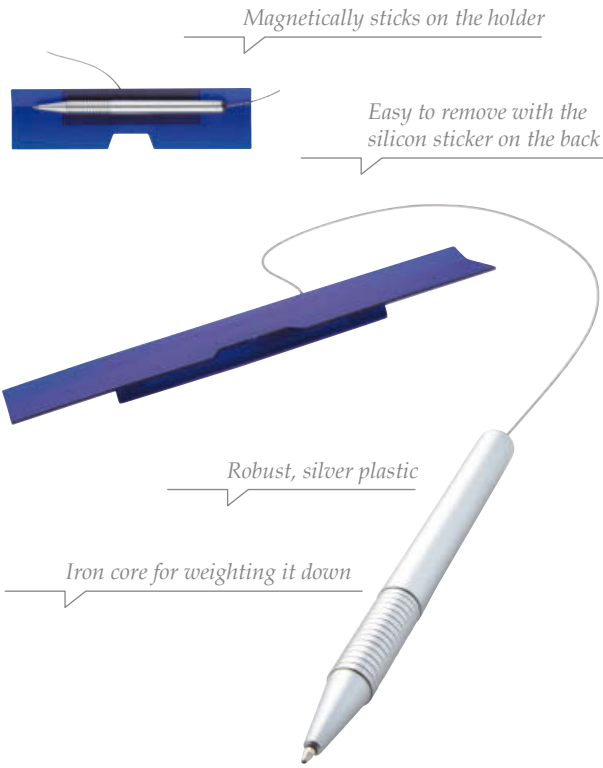

CATENA will never let your customers down!

CATENA 58-1102397 Plastic ballpoint pen CATENA: with an iron core to weigh it down and wall holder with silicone adhesive tape – pen adheres thanks to magnet in holder, blue ink.

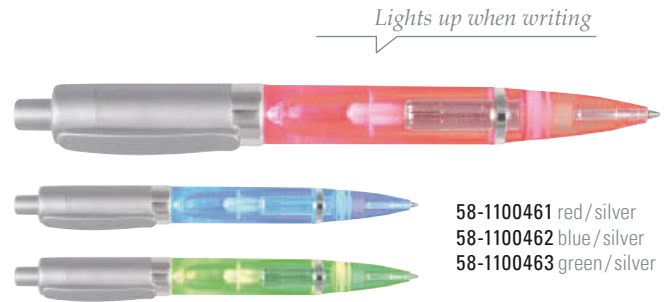
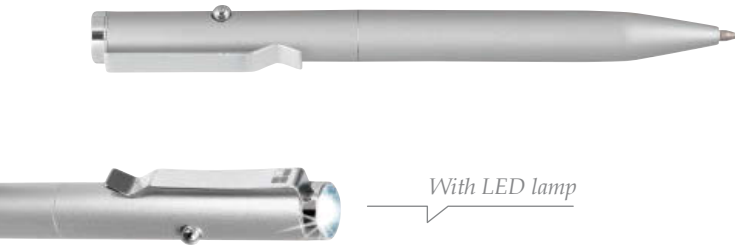
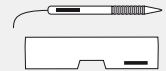

Packing: 200 pcs. / 50 pcs. | Size: 16,5x4,2x2 / 13x1,3 cm |

Branding:  20x5 mm K1+H2



LOOK 58-1101607 Metal ballpoint pen LOOK: with white LED lamp at the end of the shaft, twist mechanism, blue ink, delivered in case.

Packing: 200 pcs. / 50 pcs. | Size: 16 x 3 x 3 / 13,1 x 1,1 cm |

Branding:  35 x 5 mm K2+H4+V1 |  35 x 5 mm L2+H4

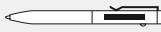

LUXOGRAPH LIGHT Ballpoint pen LUXOGRAPH

LIGHT: with small LED light - activated through spring mechanism, pen lights up in different colours, blue ink, made of plastic.

Packing: 500 pcs. / 10 pcs. | Size: 14xØ1,8 cm | Branding:  25x6 mm K1+H1

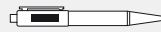

Tricky designer pen for spectacular writing performance.

UPPSALA 58-1101717 Ballpoint pen UPPSALA: unfolds to 16,7 cm when the button is pressed, measures 9,7 cm when folded and fits in every coat or trouser pocket, blue ink, made of plastic.

Packing: 400 pcs./200 pcs. | Size: 9,7x1,7x2,2cm | Branding: ☹ 20x10mm K1+H3

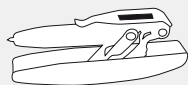

Unfolds at the push of a button

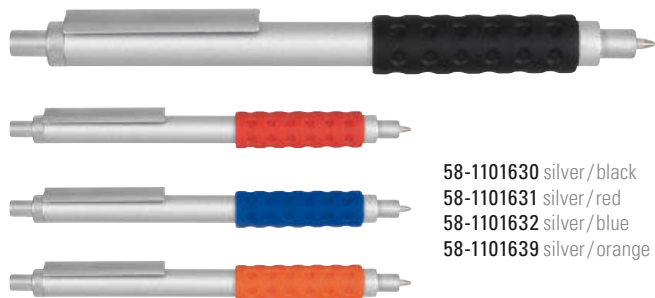

58-1101630 silver/black
58-1101631 silver/red
58-1101632 silver/blue
58-1101639 silver/orange



GRIP Metal ballpoint pen GRIP: with spring mechanism, ergonomic and rubberized grip in a wave design, blue ink.

Packing: 500 pcs./50 pcs. | Size: 14,2x1,3cm | Branding: ☹ 40x5mm K2+H4+V1 | ☹ 40x5mm L2+H4



MAX 58-1100471 Ballpoint pen MAX in compact design: with spring mechanism, decorative rubber grip, blue ink, made of plastic.

Packing: 500 pcs./10 pcs. | Size: 13,2xØ2,5cm | Branding: ☹ 20x7mm K1+H1



1



2



3



4



5



6



Decorated with CRYSTALLIZED™-
Swarovski Element



1 ROCK 58-1101590 Metal ballpoint pen ROCK: with twist mechanism, decorated with precious CRYSTALLIZED™-Swarovski Elements on the clip, blue ink, delivered in case.

Packing: 50 pcs. / 10 pcs. | Size: 18,5x7,8x3,3 / 13x1,3 cm |

Branding: ☑ 35x5 mm K2+H4+V2 | ☑ 180x70 mm DP2+H2 | ☑ 35x5 mm L2+H4



Clip in PiCOWORLD design



2 CARBONIUM 58-1102050 Metal ballpoint pen CARBONIUM: with twist mechanism, real carbon finish, silver clip in PiCOWORLD design, blue ink, delivered in case.

Packing: 200 pcs. / 50 pcs. | Size: 16x3x3 / 13,7x1 cm |

Branding: ☑ 25x6 mm L2+H4



58-1102211 red / silver
58-1102212 blue / silver



3 CANCUN 58-1102291 Ballpoint pen CANCUN: with spring mechanism, diamond pattern engraving on shaft, black ink.

Packing: 500 pcs. / 50 pcs. | Size: 13,5xØ1 cm |

Branding: ☑ 20x60 mm LR2+H4 360° | ☑ 40x6 mm L1+H4



4 SOKRATES Metal ballpoint pen SOKRATES: with spring mechanism - can be fixed onto a lanyard thanks to a little hole on the push button - aluminium rings on the grip, blue ink.

Packing: 500 pcs. / 50 pcs. | Size: 14xØ0,9 cm |

Branding: ☑ 20x60 mm LR2+H2 360° | ☑ 40x5 mm L1+H2



Clip in PiCOWORLD design



Transparent centre part with
moveable Swarovski Elements



58-1103025 black
58-1103028 white

5 SUCCESS 58-1102320 Metal ballpoint pen SUCCESS: with twist mechanism, "success" written on shaft in 14 languages, clip in PiCOWORLD design, blue ink, delivered in case.

Packing: 200 pcs. / 50 pcs. | Size: 18,2x4x2,3 / 13,5x1,3 cm |

Branding: ☑ 25x10 mm K2+H4+V2 | ☑ 25x10 mm L2+H4



6 DIAMOND Metal ballpoint pen DIAMOND: with twist mechanism, transparent centre piece with movable CRYSTALLIZED™-Swarovski crystals, clip in PiCOWORLD design, blue ink, delivered in case.

Packing: 200 pcs. / 50 pcs. | Size: 14x1 cm | Branding: ☑ 20x5 mm L2+H4



Our pens have that certain something that will impress your customers.





Clip in PiCOWORLD design



PRECISE 58-1102287 Metal roller pen PRECISE: rubberized grip at mid-point, clip on cap in PiCOWORLD design, black ink, delivered in case.

Packing: 200 pcs./50 pcs. | Size: 18,2x4x2,3/14x1,4cm |

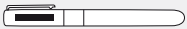

Branding:  25x10mm DP1+H4 |  25x10mm L2+H4 |

 40x40mm LR2+H4 360°



ALL IN ONE 58-1102370 Multi-functional pen ALL IN ONE: 3 tools in one pen - ballpoint pen (blue ink), pencil and PDA stylus, with spring mechanism, made of aluminium.

Packing: 200 pcs./50 pcs. | Size: 18,2x4x2,3/14x1 cm |

Branding:  25x25mm LR1+H4 360° |  25x5mm L2+H4



With precious CRYSTALIZED™-
Swarovski Elements

Clip in exclusive PiCOWORLD design



MOSCOW 58-1101560 Metal ballpoint pen MOSCOW in black piano lacquer look: with twist mechanism, clip in PiCOWORLD design, 24 CHRYSTALLIZED™-Swarovski Elements on the shaft, blue ink, delivered in case.

Packing: 50 pcs. / 10 pcs. | Size: 20,5x8,3x3,3 / 13,5x1,9cm |

Branding: ☒ 35x5mm K2+H4+V2 | ☒ 180x70mm DP2+H2 | ☒ 35x5mm L2+H4



Clip in exclusive PiCOWORLD design



With precious CRYSTALIZED™-
Swarovski Elements



RIGA 58-1101570 Metal roller pen RIGA in black piano lacquer look: cap with clip in PiCOWORLD design, 24 CHRYSTALLIZED™-Swarovski Elements on the shaft, black ink, delivered in case.

Packing: 50 pcs. / 10 pcs. | Size: 18,5x7,8x3,3 / 13x1,3cm |

Branding: ☒ 35x5mm K2+H4+V2 | ☒ 180x70mm DP2+H2 | ☒ 35x5mm L2+H4



Clip in exclusive PiCOWORLD design



With precious CRYSTALIZED™-
Swarovski Elements



ST. PETERSBURG 58-1101580 Metal fountain pen ST. PETERSBURG in black piano lacquer look: with Iridium Point nib, cap with clip in PiCOWORLD design, 24 CHRYSTALLIZED™-Swarovski Elements on the shaft, incl. 1 ink-refill, delivered in case.



Packing: 50 pcs. / 10 pcs. | Size: 19,2x8,3x3,3 / 13,6x1,3cm |

Branding: ☒ 35x5mm K2+H4+V2 | ☒ 180x70mm DP2+H2 | ☒ 35x5mm L2+H4



CHAMPAGNE 58-1100687 Metal ballpoint pen CHAMPAGNE: with twist mechanism, delicate mosaic design, blue ink, supplied in elegant PU-leather presentation box with metal plate for your advertisement.



Packing: 100 pcs. / 10 pcs. | Size: 18,2x5,7x3,5 / 14x1,5 cm |

Branding:  30x5 / 25x5 mm K2+H4+V2 |  30x5 / 25x5 mm L2+H4



CALLIGRAPH 58-1100520 Metal ballpoint pen CALLIGRAPH: with twist mechanism, glossy chrome elements, blue ink, supplied in gift box with embossed leatherette.

Packing: 200 pcs. / 25 pcs. | Size: 15,8xØ2,7 / 14x1 cm |



Branding:  25x6 mm K2+H5+V2 |  25x6 mm L2+H4



Delicate embossing

KIEV 58-1102190 Metal ballpoint pen KIEV: with twist mechanism, gold trim, with precious CRYSTALLIZED™-Swarovski Element on the clip, blue ink, delivered in gift box.

Packing: 50 pcs. / 10 pcs. | Size: 18,5x7,8x3,3 / 13x1,3 cm |

Branding:  35x5 mm K2+H4+V2 |  180x70 mm DP2+H2 |  35x5 mm L2+H4



A striking contrast: accents in shiny gold tones



With precious CRYSTALLIZED™-Swarovski Elements



PiCO pens radiate natural charme.

BORG 58-1102259 Wooden ballpoint pen BORG: with twist mechanism, silver decorative elements, blue ink, supplied in wooden gift box.



Packing: 100 pcs. / 25 pcs. | Size: 16x3x3 / 14x1 cm |

Branding:  30x1 mm K2+H5 |  30x5 mm K2+H5



FLEX 58-1101840 Metal ballpoint pen FLEX: with twist mechanism, piano lacquer look with chrome elements, ergonomic grip for best handiness, with picopen logo, blue ink, delivered in case.

Packing: 50 pcs. / 10 pcs. | Size: 18,5x7,8x3,3 / 13,6x1,3cm |

Branding:  35x5 mm K2+H4+V2 |  35x5 mm L2+H4



58-1100660 black/silver

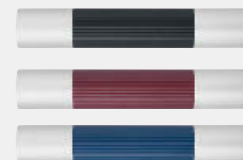

58-1100661 red/silver

58-1100662 blue/silver



COLUMN Metal ballpoint pen COLUMN: with twist mechanism, coloured and shiny chrome-plated barrel, blue ink, supplied in matching gift box.

Packing: 200 pcs. / 10 pcs. | Size: 15,7xØ2,7 / 13,8x1,2cm |

Branding:  30x5 mm K2+H6+V2 |  30x5 mm L2+H6







58-1100630 black/silver
58-1100631 red/silver



Elegant cases are the icing on the cake.

ADORNO Writing set ADORNO: consists of metal roller ball (black ink) with cap and black grip and metal twist action ballpoint pen (blue ink), delivered in matching striped box.

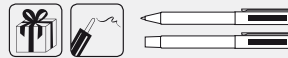

Packing: 100 pcs./10 pcs. | Size: 17x6x2,3/13,8x1,9 cm |
Branding:  35x5 mm K2+H5 |  150x50 mm DP2+H2 |  35x5 mm L2+H5



58-1100620 black/silver
58-1100621 red/silver
58-1100622 blue/silver



ADORNO Metal ballpoint pen ADORNO: with twist mechanism, body with striped design, blue ink, delivered in matching striped box.

Packing: 100 pcs./10 pcs. | Size: 17x6x2,3/13,8x1,9 cm |
Branding:  35x5 mm K2+H4 |  170x60 mm DP2+H2 |  35x5 mm L2+H4





58-1100490 black/silver
58-1100497 silver



STERLING Writing set STERLING: consists of metal roller ball with cap (black ink) and metal twist action ballpoint pen with high-capacity refill (blue ink), delivered in elegant gift box with aluminium plate.

Packing: 50 pcs. / 10 pcs. | Size: 17,3x6,7x3,5/14x1,2 cm |

Branding: ☒ 30x6 mm K2+H5+V2 | ☒ 40x40 mm K2+H2+V2 |

☒ 40x40 mm DP2+H2 | ☒ 30x6 mm L2+H5 | ☒ 40x40 mm L2+H2



COMTESSE 58-1100464 Writing set COMTESSE: consists of metal roller ball with cap (black ink) and metal twist action ballpoint pen (blue ink), with polished chrome elements, comes in gift box.

Packing: 100 pcs. / 10 pcs. | Size: 17x4,5x2/13,7x1,3 cm |

Branding: ☒ 20x5 mm K2+H5+V1 | ☒ 150x40 mm DP2+H2 | ☒ 20x5 mm L2+H5



Clip in PiCOWORLD design



ALBUS 58-1102335 Writing set ALBUS: consists of roller pen with cap and black grip (black ink) and twist action ballpoint pen (blue ink), with chrome applications, delivered in white gift box with aluminium plate.

Packing: 50 pcs. / 10 pcs. | Size: 17,6x6,8x3,8/13,8x1,2 cm |

Branding: ☒ 40x40/35x5 mm K2+H2+V2 | ☒ 35x5 mm K2+H5+V2 |

☒ 40x40 mm DP2+H2 | ☒ 35x5 mm L2+H5







Clip in PiCOWORLD design



A true classic! Low cost, easy to print on and with high practical value.

WOOD AND METAL 58-1103037 Writing set WOOD AND METAL: consists of metal roller pen with cap (black ink) and metal twist action ballpoint pen (blue ink), brushed shafts with glossy decorative elements, clip in PiCOWORLD design, supplied in a bamboo gift box.

Packing: 50 pcs. / 25 pcs. | Size: 14 x 1,3 / 17,5 x 5,5 x 2,6 cm |

Branding:  175 x 55 mm DP2+H2 |  20 x 5 mm L2+H4



58-1100420 black/silver
58-1100422 blue/silver





With rotary mechanism: turn into one direction for adjusting the refill and into opposite direction for fixation



EDITOR Writing set EDITOR: consists of pencil and twist action ballpoint pen (blue ink), satin finished metal and finely ribbed coloured plastic body, supplied in box.

Packing: 100 pcs. / 10 pcs. | Size: 16,3 x 6,2 x 2,6 / 13,3 x 1,4 cm |

Branding:  30 x 5 mm K2+H5+V2 |  160 x 60 mm DP2+H2 |  30 x 5 mm L2+H5



PRECIOUS 58-1102450 Writing set PRECIOUS: consists of ballpoint pen (blue ink) and pencil with twist mechanism, both writing utensils have an exclusive wooden design with chrome-plated decorative elements, triangular shaped shaft, delivered in gift box with maplewood applications.

Packing: 50 pcs. / 25 pcs. | Size: 20 x 7,5 x 4,7 / 14,3 x 1,2 cm |

Branding:  25 x 10 / 40 x 30 mm K2+H4



For peak performance –
great products with
power of endurance!

OLYMPIC 58-1102317 Writing set OLYMPIC: consists of metal roller pen with cap (black ink) and metal twist action ballpoint pen (blue ink), with delicate helix engraving on shaft, delivered in a stylish box with aluminium plate for your advertising.

Packing: 50 pcs. / 10 pcs. | Size: 17,4x6,7x3,5 / 14x1,7 cm |

Branding: ☒ 40x40 mm K2+H2+V2 | ☒ 35x5 mm K2+H5+V2 |

☒ 40x40 mm DP2+H2 | ☒ 35x5 mm L2+H5 | ☒ 40x40 mm L2+H2

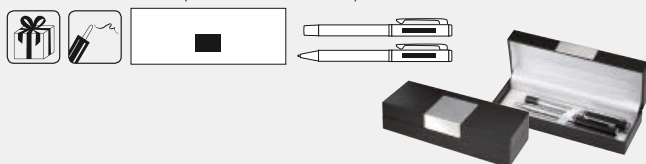

BROADWAY 58-1100410 Writing set BROADWAY: consists of metal roller ball with cap (black ink) and metal twist action ballpoint pen (blue ink), with interwoven black and shiny chrome finish on the barrel, supplied in box.

Packing: 100 pcs. / 10 pcs. | Size: 16,2x6x2,8 / 14,1x1,1 cm |

Branding: ☒ 30x3 mm K2+H5+V2 | ☒ 160x60 mm DP2+H2 | ☒ 30x3 mm L2+H5

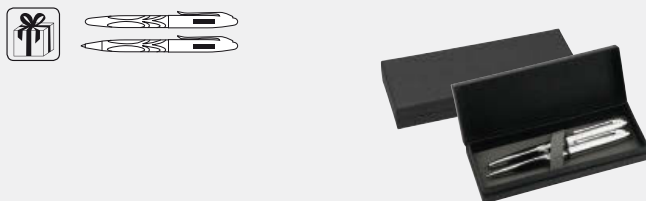

SKRIPTUS 58-1100500 Writing set SKRIPTUS: consists of metal roller ball with cap (black ink) and metal twist action ballpoint pen (blue ink), with silver decor elements, comes in gift box.

Packing: 100 pcs. / 10 pcs. | Size: 16x5,5x3,5 / 13x1,3 cm |

Branding: ☒ 30x15 mm K2+H2+V2 | ☒ 35x5 mm K2+H5+V2 |

☒ 30x15 mm L2+H2 | ☒ 35x5 mm L2+H5

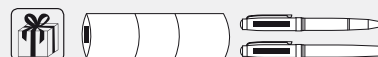



Two elegant helpers, for a great writing experience.

BLACK ELEGANCE 58-8114001 Writing set BLACK ELEGANCE: consists of ballpoint pen with twist mechanism and metal refill (black ink), and fountain pen with ink cartridge (blue ink) in gun-metal look with rubber-coated grip, both writing instruments with PiCOWORLD clip, black gift box with drawer and decorative edge made of aluminium.

Packing: 50 sets / 25 sets | Size: 19,8x7,9x3,7 cm | Branding: ☞ 40x6 mm K2+H5 | ☞ 40x6 mm L1+H5 | ☞ 90x3 mm L1+H4



BOHEMIAN 58-1100530 Writing set BOHEMIAN: consists of metal roller ball with cap (black ink) and metal twist action ballpoint pen (blue ink), with silver decor elements, supplied in gift box with metal inset.

Packing: 50 pcs. / 25 pcs. | Size: 18,0x6,5x4/13x1,3 cm | Branding: ☞ 25x5 mm K2+H5+V2 | ☞ 40x40 mm K2+H2+V2 | ☞ 40x40 mm DP2+H2 | ☞ 25x5 mm L2+H5 | ☞ 40x40 mm L2+H2

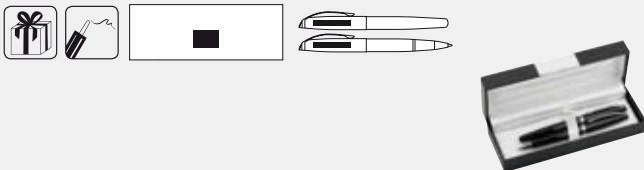

CARBON 58-1100580 Writing set CARBON: consists of metal roller ball with cap (black ink) and metal twist action ballpoint pen (blue ink), real carbon finish, clip with PiCOWORLD design, supplied in elegant gift box with metal inset.

Packing: 50 pcs. / 10 pcs. | Size: 17,5x7x4/13,8x1,3 cm | Branding: ☞ 35x5 mm K2+H5+V2 | ☞ 40x40 mm K2+H5+V2 | ☞ 40x40 mm DP2+H2 | ☞ 35x5 mm L2+H5 | ☞ 40x40 mm L2+H5

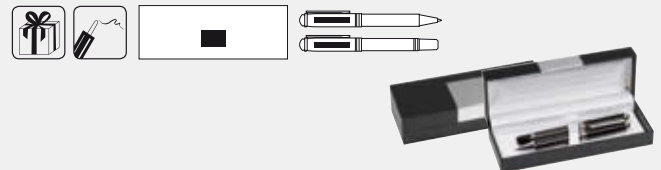

Clip in PiCOWORLD design

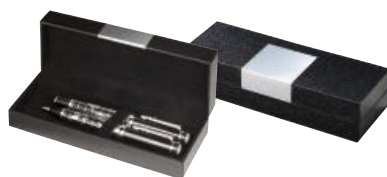

INTERCONTINENTAL 58-1102300 Writing set INTERCONTINENTAL: consists of metal roller pen with cap (black ink) and metal twist action ballpoint pen (blue ink), with brilliant chrome world map design on shaft, clip in PiCOWORLD design, delivered in a stylish box with aluminium plate.

Packing: 50 pcs. / 10 pcs. | Size: 18x6,5x4 / 14x1,5cm |

Branding: ☒ 35x5mm K2+H5+V2 | ☒ 40x40mm K2+H2+V2 |

☒ 40x40mm DP2+H2 | ☒ 35x5mm L2+H5 | ☒ 40x40mm L2+H5



TRIO 58-1102410 Writing set TRIO, 3 pcs: consists of fountain pen with iridium nib, incl. 1 ink cartridge, roller pen (black ink) and twist action ballpoint pen (blue ink), pens made of solid metal with piano lacquer finish and brilliant chrome elements, delivered in gift box with aluminium plate for your advertisement.

Packing: 50 pcs. / 10 pcs. | Size: 13,8x1,1 / 17,8x6,6x2,5cm |

Branding: ☒ 35x5mm K2+H5+V2 | ☒ 40x40mm K2+H5+V2 |

☒ 40x40mm DP2+H2 | ☒ 35x5mm L2+H5 | ☒ 40x40mm L2+H5

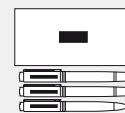

Front Office Joint venture of form and function!

Even if you don't want to believe it, but a person spends most of their time at work. Which is ideally supposed to be fun, therefore the equipment has to be just right. Starting from the computer all the way to the small office helpers. Working with a stylish letter opener or a fancy calculator, it makes easier to get the job done in no time!

Our picooffice ideas guarantee fun for everyone. They are more than industrious everyday helpers; many of them are celebrated for their entertainment value.



highlight

SHERLOCK 58-8116002 Magnifying glass
SHERLOCK with 3-fold magnification, 2 white LED lights, on/off switch on the side, with fold-out stand, batteries: 2 x AA (excl.).
Packing: 100 pcs. / 25 pcs. | Size: 16,3x7,6x2 cm |
Branding: ☞ 22x10 mm K2+H4+V2 | ☞ 20x10 mm DP1+H4



picooffice



picooffice



WINGMAN 58-1101515 Rotating calculator WINGMAN in handy size: display is automatically extended and retracted by pressing a button, with rubberized keypad, 8-digit.

Packing: 100 pcs. / 50 pcs. | Size: 10,6x3,6x1,8 cm |

Branding:  Ø20 mm K2+H2+V1



NOIR 58-1101870 Calculator NOIR: display is almost invisible when turned off, 8-digit, delivered in velvet bag.

Packing: 100 pcs. / 50 pcs. | Size: 11,2x6,6x0,9 cm |

Branding:  40x7 mm K2+H3+V1

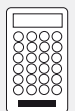

Practical and beautiful don't go together? Our PicoOffice treasures prove they do!



TRANS-SCRIPT 58-1102380 Calculator TRANS-SCRIPT, 10-digit: with integrated translator for 6 languages (German, English, French, Spanish, Dutch, Italian), 120 sentences and 5000 words, with ruler (30 cm) and date and time display.

Packing: 60 pcs. /30 pcs. | Size: 31 x5,6x0,9 cm | Branding: ☞ 40x30mm K2+H3

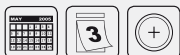

TRONDHEIM 58-1102010 Paper weight TRONDHEIM, rotating: made of heavy black metal to weigh down letters or documents, star ends adorned with sparkling rhinestones.

Packing: 24 pcs. | Size: 12,2x12,2x1,1 cm | Branding: ☞ 30x30mm K2+H2+V2



BERGEN 58-1101967 Letter opener BERGEN: with rhinestones on the handle, made of heavyweight metal.

Packing: 50 pcs. | Size: 19,6x2,1 x0,8 cm | Branding: ☞ 60x10mm L2+H4



Made of highly polished aluminium



58-1102361 red
58-1102362 blue
58-1102364 gold



MEMO Mini notepad MEMO: handy breast pocket size, with twist action ballpoint pen (black ink) attached to the side, made of shiny aluminium.

Packing: 100 pcs./20 pcs. | Size: 11 x 7 x 1 cm | Branding: ☒ 40 x 30 mm K2+H3+V1 | ☒ 100 x 60 mm DP2+H2 | ☒ 40 x 30 mm L2+H3

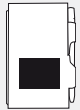

58-0401530 black
58-0401535 white



DORADO 58-1101210 Pen holder DORADO: convenient mug shape in slightly slanted design, with chromed rim, made of metal.

Packing: 40 pcs./20 pcs. | Size: 9,4 x Ø 6 cm | Branding: ☒ 50 x 15 mm K2+H6+V2 | ☒ 130 x 50 mm LR3+H6 360° | ☒ 50 x 15 mm L2+H6

KALMAR Memo holder KALMAR: suitable for photos and notes, with practical snap clip, made of plastic.

Packing: 400 pcs./100 pcs. | Size: 6,5 x 4,3 x 3,9 cm | Branding: ☒ 25 x 25 mm K1+H1+V1



Business à la carte: Never lose track of business cards again.

MASTER FILE 58-8117000 Address register MASTER FILE: two drawers with address and number register, ideal for storing business cards, made of shiny black metal with piano lacquer finish.

Packing: 10 pcs. | Size: 11,8x13,3x16,4 cm | Branding: 🖨️ 20x30 mm L2+H6

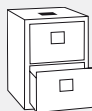

Case made of transparent acrylic



LILLEHAMMER 58-1102037 Business card case
LILLEHAMMER: with spring lock, made of silver-coloured metal and transparent acrylic.

Packing: 100 pcs. | Size: 10,4x6,8x1 cm | Branding: 🖨️ 50x25 mm K2+H2+V1 |
🖨️ 50x30 mm DP2+H2 | 🖨️ 50x30 mm L2+H2





1



2



3



4



5



6



With solenoid shutter on both sides

1 SAO PAULO 58-1101260 Business card holder SAO PAULO made of elegant leatherette: with magnetic clasps on both sides.

Packing: 200 pcs. / 50 pcs. | Size: 10x6x1,5 cm | Branding: ☒ 50x10 mm DP1+H2 | ☒ 50x10 mm L2+H2



2 RIO 58-1101690 Business card case RIO: aluminium inside, high quality leatherette outside, with secure metal magnetic clasp where your logo can be advertised.

Packing: 100 pcs. / 20 pcs. | Size: 10x6,5x1,5 cm | Branding: ☒ 25x10 mm L2+H2



3 IDENTITY 58-1101027 Business card case IDENTITY: with hinged breech block, made of matt aluminium.

Packing: 500 pcs. / 50 pcs. | Size: 9,4x6,2x0,8 cm | Branding: ☒ 50x25 mm K2+H2+V1 | ☒ 90x50 mm DP2+H2 | ☒ 50x50 mm L1+H2



Made of real leather with an inlaid slipcase

4 PROFESSION 58-1101000 Business card case PROFESSION: made of precious leather.

Packing: 200 pcs. / 50 pcs. | Size: 10,2x6,9x1,9 cm | Branding: ☒ 45x20 mm K2+H2



5 FREDRIKSHAVEN Business card holder FREDRIKSHAVEN: swings open, made of metal and plastic.

Packing: 50 pcs. | Size: 10,1x6,4x2 cm | Branding: ☒ 70x20 mm K2+H3 | ☒ 70x50 mm DP2+H2



6 PIET 58-1102230 Business card case PIET: interior has a velvet lining to protect business cards, outside polished base and top cover in textured leather look refined with white stitching, with secure magnetic clasp.

Packing: 100 pcs. / 20 pcs. | Size: 9,6x6,4x1 cm | Branding: ☒ 70x7 mm L1+H2





MILANO-TRAVEL 58-1101350 Briefcase MILANO-TRAVEL in leatherette look: capacity for 8 credit cards, papers and A5 notepad (excl.), 1 transparent pocket, pen holder, with silver magnetic clasp, incl. non-woven bag.
 Packing: 20 pcs. | Size: 23,3 x 14 x 1,5 cm | Branding:  30 x 8 mm L2+H4



HALMSTAD 58-1102130 Business folder HALMSTAD: with 4 different-sized compartments for ticket, passport, visa and boarding card, pen holder, all-around zip, made of sturdy twill.
 Packing: 60 pcs. | Size: 25,5 x 14 x 2 cm | Branding:  50 x 20 mm T2+H2



All-rounder for everyday business



MILANO-PORTFOLIO II 58-1101340 Organizer
MILANO-PORTFOLIO II in leatherette look: provides space for 6 business or credit cards, 2 large pockets for papers, pen holder, incl. notepad (A5), incl. non-woven bag.

Packing: 20 pcs. | Size: 23,7 x 15,2 x 1,5 cm | Branding: 30 x 8 mm L2+H4



CLASSICO-PORTFOLIO II 58-1101380 Organizer
CLASSICO-PORTFOLIO II in real leather look: with various separate pockets, pen holder, incl. A5 notepad, with magnetic metal clasp, incl. non-woven bag.

Packing: 20 pcs. | Size: 24 x 15,4 x 1,8 cm | Branding: 50 x 20 mm K2+H4 | 30 x 8 mm L2+H4



Great helpers! Everything you need is inside our portfolios and briefcases.



MILANO-PORTFOLIO 58-1101330 Organizer
 MILANO-PORTFOLIO in leatherette look: with calculator, 2 business card pockets, 2 pockets for papers, pen holder, incl. notepad (A4), with safe all-around zip, incl. non-woven bag.
 Packing: 20 pcs. | Size: 32 x 24,3 x 2,5 cm | Branding:  30 x 8 mm L2+H4



CLASSICO-PORTFOLIO 58-1101370 Organizer
 CLASSICO-PORTFOLIO in real leather look: with ultra slim calculator, 2 business or credit card pockets, 1 pocket for papers, 1 pocket for a notepad, pen holder, incl. A4 notepad.
 Packing: 10 pcs. | Size: 32 x 25 x 2 cm | Branding:  30 x 8 mm L2+H4

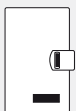

EMINENCE 58-8081004 Portfolio EMINENCE in DIN A4 format:
 with all-around zip, various slip-in pockets for business cards and documents, additional zip pocket, incl. notepad, pen holder, made of PVC and felt.
 Packing: 20 pcs. / 10 pcs. | Size: 34 x 25 x 3,5 cm | Branding:  50 x 50 mm T2+H2

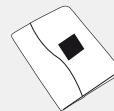



without decoration

SILVER-LINE PORTFOLIO 58-1101490 Organizer
 SILVER-LINE PORTFOLIO in real leather look: with calculator, 3 pen holders, 7
 business card pockets, incl. A4 notepad, secure magnetic closure, silver-coloured
 printing and engraving area for your advertisement, made of polyurethane, incl.
 non-woven bag.

Packing: 10 pcs. | Size: 32,5x29,5x2,5 cm | Branding: 📏 10x20 mm L2+H4



EMINENCE 58-8081003 Document portfolio EMINENCE in DIN
 A4 format: with all-around zip, ring binder, various slip-on pockets for business
 cards and documents, additional zip pocket, incl. notepad, PVC carrying handle, felt
 surface.

Packing: 10 pcs. / 5 pcs. | Size: 35,5x25x5 cm | Branding: 📏 50x50 mm T2+H2



without decoration



Let us take
some weight off
your shoulders!

CLASSICO-BAG 58-1101410 Briefcase CLASSICO-BAG in real leather look: 2 reinforced pockets for A4 documents, adjustable, reinforced and padded shoulder strap, with metal security lock, made of polyurethane, incl. non-woven bag.

Packing: 10 pcs. | Size: 39x29,5x5,5 cm | Branding:  20x8 mm L2+H3



without decoration

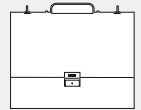

Padded comfortable carrying handle

Adjustable, soft padded shoulder strap



3-digit security combination lock

Reinforced document compartments

Incl. non-woven bag



without decoration



SILVER-LINE BAG 58-1101500 Briefcase SILVER-LINE BAG in real leather look: 3 large compartments, including mobile phone and pen holder, 4 credit card pockets, 1 small zipped pocket, 1 laptop zip compartment and extra pocket, adjustable shoulder strap, reinforced handle, combination lock, silver-coloured printing and engraving area for your advertisement, made of polyurethane, incl. non-woven bag.

Packing: 5 pcs. | Size: 41,5x32x11 cm | Branding:  10x20 mm L2+H4



Grey eminence – feel confident with PiCOWORLD's briefcases.

EMINENCE 58-8081002 Document bag EMINENCE: organizing pocket for pens and smartphone, spacious main pocket with extension fold, metal locks, carrying handle, adjustable and removable shoulder strap, made of felt and PVC.

Packing: 10 pcs./5 pcs. | Size: 40x32x6cm | Branding:  50x50 mm T2+H2



EMINENCE 58-8081001 Shoulder bag EMINENCE: organizer with carabiner to attach keys, 2 zip pockets, one Velcro pocket, various slip-in pockets, a spacious main zip compartment with zipped extension fold, cover with snap locks and hidden zip compartment, carrying handle, adjustable and removable shoulder strap, made of felt and PVC.

Packing: 15 pcs./5 pcs. | Size: 42x35x10 cm | Branding:  50x50 mm T2+H2



NEW AGE 58-8084000 Portfolio NEW AGE in leatherette look: with removable iPad cover (approx. 24 x 17,7 cm), space for 5 business cards and notepad, 1 transparent pocket, 1 large slip-in pocket, pen holder, with all-around zip.

Packing: 10 pcs. | Size: 29,3x23,3x3,5/24,5x21 x 1,7 cm |

Branding:  90x30 mm S2+H4



Removeable cover for iPad 2 (format approx. 24 x 17,7cm) with stand



MOBILITY 58-8105001 Protective cover MOBILITY – for iPad 2 or tablet PCs (approx. 24 x 17,7 cm): elastic strap, fold-out pocket for notes - can also be used as stand, inside covered with velvet velour, with hole for camera framed by metal insert, outside leather-look with decorative stitching and closing flap.

Packing: 50 pcs./25 pcs. | Size: 19,8 x 25 x 1,8 cm |

Built-in camera-hole rimmed with metal eyelet



Elastic strap for easy handling



With fold-out pocket for notes - also used as a stand



BACKPACK 58-1102460 Computer bag BACKPACK: 2 main zip pockets, one with padded laptop compartment, 2 zip front pockets, integrated organizer, padded back area, adjustable shoulder straps, strong handle, dirt-resisting base, made of robust nylon.

Packing: 10 pcs. | Size: approx. 43x32 x 14 cm | Branding:  50x30 mm T2+H2



Ideal protection for
our digital darlings.



12 compartments with
4 CD pockets each



PROTECT 58-1101420 Neoprene laptop bag PROTECT: with protective padding, all-around zip, Velcro inside to secure laptop and tablet PC, suitable for devices up to a size of ca. 24 x 34 cm, made of water-repellent neoprene, incl. non-woven bag.

Packing: 20 pcs. | Size: 39x30x1,3 cm | Branding:  80x80 mm T2+H2



SILVER-LINE CD-CASE 58-1101480 SILVER-LINE CD-CASE in real leather look: provides space for 48 CDs, with silver-coloured printing and engraving area for your advertisement, made of polyurethane, incl. non-woven bag.

Packing: 20 pcs. | Size: 18,2x32,5x2 cm | Branding:  10x20 mm L2+H4



UNIVERSAL 58-1103060 USB kit UNIVERSAL: incl. optical mini mouse with 2 buttons, scroll wheel and cable reel, card reader (Mini SD, SD, XD, MS), 4-port HUB, USB number pad, supplied in zip case with printing and engraving plate for your advertisement.

Packing: 24 pcs. | Size: 22,5x15,5x5 cm | Branding:  50x5 mm L2+H4



The PiCO mice will click with your customers.



PC TRACER 58-1102227 Optical USB computer mouse PC TRACKER in the shape of a racing car: 2 buttons and scroll wheel, USB cable (length approx. 145 cm), shining head- and backlights, resolution: 800 dpi, Plug + Play (no software needed).

Packing: 100 pcs. / 25 pcs. | Size: 10,2x5,2x3,5 cm |

Branding:  30x15 mm K2+H4+V1

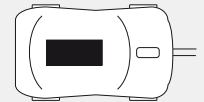

58-1102610 black
58-1102630 white



SINUO Optical mouse SINUO, wireless: with 2 buttons and scroll wheel, USB dongle attached to bottom side with magnet, resolution: 800/1.600 dpi, range: up to 10 m, Plug + Play (no software needed), batteries: 2xAAA (excl.).

Packing: 100 pcs. / 20 pcs. | Size: 11,4x5,7x3,3 cm | Branding:  30x10 mm K2+H4





PLAY IT 58-0401555 Key ring PLAY IT: with digital photo frame, storage capacity: 1 MB (approx. 35 pictures), date and time display, alarm function, two games, incl. USB cable (length approx. 123 cm), made of solid plastic.

Packing: 50 pcs. / 25 pcs. | Size: 7,5x4,5x1,7 cm | Branding: ☒ 8x8 mm K1+H4



PRIVATE KEY 58-0300290 PC lock PRIVATE KEY: locks and unlocks the PC after exceeding a certain distance – suitable for PC and laptop users, includes CD with driver, small transmitter, USB flash drive with receiver, supplied in box with magnetic closure.

Packing: 60 pcs. | Size: 6,7 x 2,2 x 0,8 cm | Branding: ☒ 10x10 mm K2+H4+V2

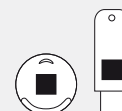

CARY 58-1103020 Card reader CARY: reads all standard memory cards: CF, SD, Mini SD, MS, Micro SC, mmC, XD - incl. USB cable (length approx. 40 cm), device supports USB 2.0, for Mac and Windows.

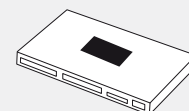

Packing: 100 pcs. | Size: 8,3x5,4x1,0 cm | Branding: ☒ 40x20 mm DP1+H2 | ☒ 40x20 mm L2+H4







TRAVEL GEAR 58-1100110 USB kit TRAVEL GEAR: 4-port HUB, mini optical mouse, swan neck fan and LED light, comes in case with metal plate for your advertisement.

Packing: 20 pcs. / 10 pcs. | Size: 16,5x16,5x5 cm |

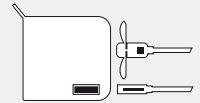
Branding:  25x25/15x5 mm K2+H4+V2 |  25x25/15x5 mm L2+H4



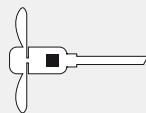

AERO FRESH 58-1100127 USB fan AERO FRESH: chrome-coated flexible neck, with USB adapter, no external power supply required.

Packing: 100 pcs. / 20 pcs. | Size: 38,3xØ1,5cm | Branding:  15x5 mm K2+H4+V2 |  10x7 mm L2+H4



VIPERE 58-1100107 USB light VIPERE: chrome-coated flexible neck, bright LED light, with USB adapter, no external power supply required.

Packing: 100 pcs. / 20 pcs. | Size: 47xØ1,5cm | Branding:  15x5 mm K2+H4+V2 |  15x10 mm L2+H4



Great sales are
in the wind!

GET FRESH 58-1102440 Desk fan GET FRESH: stainless steel casing, rubberized feet for secure footing, USB cable (length approx. 117 cm) for power supply.

Packing: 30 pcs. | Size: 14,0x15,0x9,5 cm | Branding: ☒ 25x25 mm L2+H4



ASTRONAUT 58-8101007 USB light ASTRONAUT: white LED light turns on when the protective visor is lifted up – flexible neck (length approx. 32 cm) with USB connection, in black box.

Packing: 100 pcs. / 25 pcs. | Size: 6,7x6,1x3,8 cm |

Branding: ☒ 12x10 mm K2+H6+V1 | ☒ 12x10 mm L5+H6



Reach for
the stars!





MEM KEY 58-8101001 Key ring accessory MEM KEY with integrated memory stick, capacity 4GB – in the form of a door key, with prominent advertising space.

Packing: 1000 pcs. | Size: 5,5x2,2x0,2 cm | Branding: ☞ 20x7 mm K1+H2+V2 | ☞ 20x7 mm L1+H2

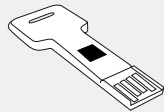

MEM CARD 58-8101002 Key ring accessory MEM CARD with foldout memory stick, capacity 4GB – in the form of a credit card, with prominent advertising space.

Packing: 500 pcs. | Size: 8,3x5,2x0,3 cm | Branding: ☞ 30x35 mm K1+H2+V2 | ☞ 30x35 mm DP1+H2



MEM PEN 58-8101003 Twist-open ballpoint pen MEM PEN, black ink: with integrated memory stick, capacity: 4GB.

Packing: 400 pcs. | Size: 13 x 1,4 cm | Branding: ☞ 35 x 6 mm K2+H4+V2 | ☞ 35 x 6 mm L4+H4 | ☞ Ø7 mm L1+H4



58-8101004 silver
58-8101005 blue
58-8101006 red

MEM FOLD 58-8101004 Key ring MEM FOLD with integrated memory stick and prominent advertising space, capacity: 4 GB.

Packing: 1000 pcs. | Size: 3,5 x 1,6 x 0,7 cm | Branding: ☞ 20 x 9 mm K1+H2+V2 | ☞ 20 x 9 mm L1+H2



Never again will your battery run low.



 NEW

Blue LED battery capacity indication



ENERGY 58-8105008 Powerbank ENERGY – the perfect power supply on the go: suitable for current smartphones and USB devices, on/off switch to check charge level and to start charging, charging starts automatically when connecting device, USB charging cable with micro USB plug (length: approx. 32 cm), with blue LED charge level indicator, input power: 5V/1A, output power: 1. port: 5V/1A, 2. port: 5V/2.1A, capacity: 6.000 mAh, high-performance lithium-ion battery.

Packing: 40 pcs./10 pcs. | Size: 15x6,8x1,3 cm |

Branding:  70x25 mm K2+H4+V1 |  140x60 mm DP2+H4 |

 100x50 mm L2+H4



With white LED light



MEGAWATT 58-8105002 Portable charger MEGAWATT: for smartphones and external devices, with adapters for iPhone 4, Micro USB, Mini USB - output power: 5 V - 1.000 mA, with integrated white LED light, powerful lithium polymer battery, capacity: 2.200 mAh with blue LED battery level display, incl. USB charging cable (length approx. 22,5cm), charging time: approx. 7 hours.

Packing: 80 pcs./20 pcs. | Size: 11,2x6,1x1 cm | Branding:  40x30 mm K2+H4 |

 40x30 mm DP2+H2



Power en route



 NEW

UPGRADE 58-8105006 Powerbank UPGRADE – the perfect power supply on the go: suitable for current smartphones and USB devices, on/off switch to check charge level and to start charging, USB charging cable with micro USB plug (length: approx. 32 cm), input power: 5V/1A, output power: 1. port: 5V/1A, 2. port: 5V/2.1A, capacity: 8.000 mAh, high-performance lithium-ion battery.

Packing: 40 pcs. / 10 pcs. | Size: 8,6x8,2x2,4cm | Branding: ☹ 45x45mm K1+H4 | ☹ 50x20mm DP1+H2 | ☹ 55x55mm DP2+H4 | ☹ 55x55mm L5+H4



GIGAWATT 58-8105003 Powerbank GIGAWATT – the perfect energy backup on the go: suitable for smartphones, iPhones, and USB devices, incl. USB cable with several connectors (length: approx. 31 cm), with blue LCD capacity display (remaining power shown in %), input power: 5V/1A, output: port 1 - 5V/1A, port 2 - 5V/2,1A, capacity: 9000 mAh, on/off switch for charging, double click to turn on/off the white LED torch light, high performance lithium-ion battery.

Packing: 40 pcs. / 10 pcs. | Size: 9x7,3x2,3cm | Branding: ☹ 35x20mm K2+H4+V2 | ☹ 40x40mm DP2+H4





 NEW



SOL 58-8105007 Powerbank SOL: suitable for current smartphones and other USB devices – with large solar panel, on switch to check charge level, charging starts automatically when connecting device, 2 USB ports, 1 micro USB port, USB charging cable with micro USB plug (length: approx. 32 cm) – 1) USB mode: input power: 5V/1A, with blue LED charge level indicator, 2) charging via solar panel: input power: 5V, 500 mA, solar charge level indicator with green LED – capacity: 10.000 mAh, output power: 1. port 5V/1A, 2. port: 5V/2.1A, when using both ports simultaneously 5V/1A each, high-performance lithium-polymer-battery.

Packing: 20 pcs. / 10 pcs. | Size: 17,7 x 12 x 0,9 cm |

Branding:  70 x 25 mm K2+H4+V1 |  160 x 90 mm DP2+H2 |

 50 x 20 mm DP1+H4 |  80 x 4 / 80 x 80 mm L2+H4

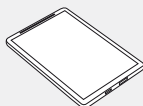



Blue LED battery capacity indication

With touch function



TERAWATT 58-8105004 Powerbank TERAWATT – the perfect energy backup on the go: suitable for smartphones, iPhones, and USB devices, incl. USB cable with several connectors (length: approx. 31 cm), with touch function and blue LED capacity display, input power: 5V/1A, output: port 1 - 5V/1A, port 2 - 5V/2A, capacity: 10.000 mAh, high performance lithium-ion battery, polished metal surface on the back side.

Packing: 40 pcs. / 10 pcs. | Size: 13 x 8,2 x 1,4 cm |

Branding:  40 x 25 mm K2+H4+V2 |  50 x 50 mm DP2+H4



DATABASE 58-8103002 Stainless steel mobile phone holder
 DATABASE – for smartphones and mobile phones: rubber-coated rotary disc allows phone to be positioned horizontally or vertically, with USB hub in the stand.

Packing: 50 pcs. / 25 pcs. | Size: 6,5x7 x 12 cm | Branding:  40 x 10 mm L2+H6

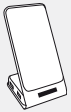



MR. U-TEC 58-8103001 Charger MR. U-TEC – for smartphones and mobile phones: charges via batteries (excl.) and USB cable (length approx. 13,3 cm), with 360° movable arms.

Packing: 200 pcs. / 100 pcs. | Size: 6,9x4,6x2,4 cm | Branding:  20 x 10 mm K2+H4



SPACE 58-1101313 Mobile phone holder SPACE: rubberized adhesive silicone surface, with chrome-plated metal base.

Packing: 100 pcs. / 50 pcs. | Size: 6,6 x 6,4 x 12,5 cm |
 Branding:  40 x 10 mm DP1+H2 |  40 x 10 mm L2+H4



Non-slip silicone surface



STAND BY ME 58-8105000

Mobile phone holder STAND BY ME – for smartphones and mobile phones: with suction cup, ideal for watching movies and looking at photos.

Packing: 1000 pcs. / 250 pcs. | Size: 3,4x4,5x1,9cm |
Branding: ☑ 20 x 10 mm K1+H1



DORADO 58-1101200

Mobile phone holder DORADO: suitable for all mobile phones, glossy chrome sides, advertisement can be applied on front side, made of metal.

Packing: 50 pcs. / 25 pcs. | Size: 7,8x5,8x6cm | Branding: ☑ 30 x 35 mm K2+H6+V2 |
☑ 30 x 35 mm L2+H6



UPRIGHT

Tablet stand UPRIGHT: plastic stand can be folded to save space, silicone corners for good surface adhesion and secure footing.

Packing: 500 pcs. / 250 pcs. | Size: 13,4x4x0,5 cm | Branding: ☑ 40 x 20 mm K1+H2 |
☑ 40 x 20 mm DP1+H2 | ☑ 60 x 20 mm L5+H2

58-8103003 black/white
58-8103004 black



Up to date Time is on our side!

Timepieces: Everyone has one and most people have more than one. There are wall clocks, grandfather clocks, watches, alarm clocks, table clocks and many, many other kinds. Which ones do you prefer? Of course we from PiCOWORLD prefer the extraordinary.



Our unique picotime ideas do not only convince by the exact time - they also stand for contemporary design and multifunctionality. Take some time and see for yourself!



highlight

MACAU 58-0401517 Travel alarm clock MACAU, foldable: with analogue time display, made of shiny metal and leatherette, Battery: 1 coin cell incl.

Packing: 100 pcs. / 50 pcs. | Size: 11/6,3 x 5,2 x 2,8 cm |

Branding:  45 x 20 mm K2+H3 |  35 x 10 mm L2+H3

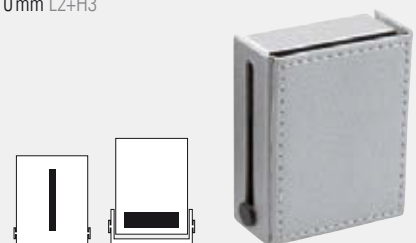



picotime



Water is life! This clock works without batteries.

DEEP BLUE 58-0401332 Table clock DEEP BLUE: digital time display - powered by water and vinegar – with closing lid on top.

Packing: 40 pcs. / 20 pcs. | Size: 10,5x9,5x8,5 cm |
Branding: ☒ 12x6 / Ø 20 mm K2+H3

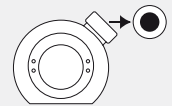

Metal plate for your advertising is affixed with a magnet



AALBORG 58-1101947 Desk clock AALBORG: chrome numerals and hands, cover made of glass, robust stand with skidproof bottom, made of high quality, shiny metal, battery: 1 x AA (excl.).

Packing: 12 pcs. | Size: Ø 16 cm | Branding: ☒ 50x10 mm L2+H3



CIRCLE 58-8044000 Rotating clock CIRCLE: with three platforms: clock, picture frame and printing and engraving area, metal plate for your advertisement is fixed with a magnet, individually arrangeable - lying down or standing, can also be used as a paperweight, 1 button cell SR 66 LR 66 with 1.55 V (incl.).

Packing: 30 pcs. | Size: 5,1 x 2,4 x 10,6/16,2 cm | Branding: ☒ 30x20 mm L2+H6

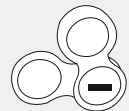

Broadcast your advertisement clear as a bell.

Decorated with 420 rhinestones



Metal bell as alarm



With mirror



ODENSE 58-1101957 Desk clock ODENSE, foldable: analogue clock and picture frame inside, mirror and 420 rhinestones outside, made of solid stainless steel.

Packing: 24 pcs. | Size: 5,2x5,1x3,8 cm | Branding:  35x35 mm L2+H3

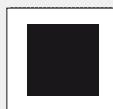

BELL 58-8044004 Table clock BELL in the shape of a bell tower with analogue time display, white dial and black clock hands, alarm function with metal bell, batteries: 2 x AA (excl.).

Packing: 30 pcs. | Size: 13x10x5 cm | Branding:  40x6/20x20 mm K2+H4+V2



WESTERN 58-0402070 Alarm clock WESTERN: includes target and gun, the alarm turns off when the target is hit, hitting noises when gun is fired, with recording function and countdown, batteries: 4x AA for target (excl.), 2x AA for gun (excl.).

Packing: 20 pcs. / 10 pcs. | Size: 14,5 x 14 x 4,4 cm | Branding: ☞ 35x20 mm K2+H4



Target with countdown

Sound when firing



ICE CLOCK 58-0401345 Designer table clock ICE CLOCK: with alarm clock, time, date and inside temperature shown on lit up display, handmade white ceramic body, Battery: 2x AAA (excl.).

Packing: 20 pcs. | Size: 10 x 8,3 x 4,2 cm | Branding: ☞ 60x20 mm K2+H2+V2



BLACK LINE 58-0401390 Radio controlled clock BLACK LINE: with integrated solar panels, alarm function, snooze, time, date, weekday and temperature display - powered by rechargeable battery and solar energy.

Packing: 50 pcs. / 25 pcs. | Size: 20 x 3,8 x 3,6 cm | Branding: ☞ 40x20 mm K2+H4+V2

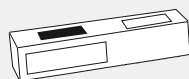

Clocks that do more than simply show the time.



SUNNY TIMES 58-0401870 Weather station SUNNY TIMES: with thermometer, hygrometer, analogue clock and alarm function, all 3 instruments come in rugged metal housing, stand with velvet velour surface, wooden frame with metal plate for your advertisement, battery: 1 x AA (excl.).

Packing: 12 pcs. | Size: 27,5x11,5x3,5cm | Branding: ☒ 50x15mm DP1+H2 |

☒ 50x15mm L2+H3



CALOR 58-0401795 Weather station CALOR: with thermometer, hygrometer, humidity and time display, blue LED background lighting, made of white ABS plastic, batteries: 2 x AAA (excl.).

Packing: 50 pcs. / 25 pcs. | Size: 13x9x3,5cm | Branding: ☒ 25x5mm K2+H3+V1

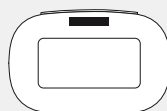

Does almost everything all by itself – the only thing you have to do is read the time!



EXACTLY 58-0401527 Radio controlled wall clock EXACTLY: automatic change from summer to winter time – in accordance to MEZ, displays temperature and humidity, brushed aluminium frame, battery: 1 x AA (excl.).

Packing: 10 pcs. | Size: Ø30 x 4 cm | Branding: ☒ 15 x 12 mm K2+H4+V2 | ☑ 15 x 12 mm L2+H4



Wireless outdoor sensor broadcasts to wall clock

COOL TIME 58-8045000 Wall clock COOL TIME: digital display with inside and outside temperature, wireless infrared sensor transfers data to the clock – sensor with stand (can be used as holder), with smooth quartz clockwork: seconds hand moves without ticking, with aluminium frame, plexiglass, plastic case, batteries for clock and sensor: 3 x AA and 2 x AAA (incl.).

Packing: 10 pcs. | Size: Ø29,9 x 4,2/5,8 x 3,7 x 9,7 cm | Branding: ☒ 15 x 12/35 x 15 mm K2+H4+V2 | ☑ 15 x 12/35 x 15 mm L2+H4



In oversize

RING RING 58-8045001 Alarm wall clock RING RING in oversize: alarm function, prominent dial, with hook on the backside, metal frame, plexiglass, plastic back, battery: C/LR14 (incl.).

Packing: 10 pcs. | Size: Ø21,5/21,5x8,8x28,5 cm | Branding: 🗑️ 30x20 mm L2+H6



ROUNDAABOUT 58-0401217 Wall clock ROUNDAABOUT: aluminium frame and clock-face, with edges wide enough to carry your logo, battery: 1xAA (excl.).

Packing: 10 pcs. | Size: 12,2xØ25 cm | Branding: 🗑️ 40x20 mm L2+H4

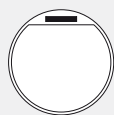

Our wallclocks make good times last longer. A logo turns them into eye-catchers!



PUNKTO 58-0400897 Wall-clock PUNKTO: with quartz movement, wide aluminium frame for your advertisement, battery: 1 x AA (excl.).
Packing: 10 pcs. | Size: 3,5 x Ø 35,1 cm | Branding:  50 x 20 mm K2+H4+V1

COUNTRY 58-8045002 Wall clock COUNTRY in retro style: dial with black and red numbers, approx. 8 cm deep plastic frame, with quartz clockwork and robust hook, battery: 1 x AA (incl.).
Packing: 10 pcs. | Size: Ø 30,1 x 10,2 cm |

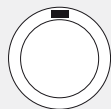

Follow the zeitgeist!



HEMERA 58-0400940 Wall-clock HEMERA: with quartz movement, made from plastic and aluminium, battery: 1 x AA (excl.).

Packing: 20 pcs. | Size: Ø31 x 3,5 cm |



PURIST 58-8045003 Wall clock PURIST: with black-gleaming hands, quartz clockwork, made of bamboo, battery: 1xAA (incl.).

Packing: 10 pcs. | Size: Ø 26 cm | Branding: ☑ 45x25 mm K2+H4

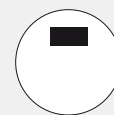

Set the tone Turn up the rich sound!

We say the tone is what makes the music. Whether you are listening to your favourite song from your mobile phone, MP3 player, iPod, iPhone ... only a good sound causes auditory delight. In the search for technical innovations and new sound highlights we are never satisfied with the first-best and pursue the ultimate solutions to meet your and your customers' needs.



Browse through the next few pages and enjoy great entertainment the PiCOWORLD way!

Touch operation

high**light**



AQUA-DISC 58-0401850 Shower radio AQUA-DISC, splash-proof: operated by touch, spiral antenna, suction cup for secure attachment, powered by 3xAAA batteries (excl.), made of ABS plastic and acrylic.

Packing: 60 pcs. /30 pcs. | Size: Ø 11,3x4 cm | Branding:  30x30 mm K2+H4+V1 |  30x30 mm DP1+H2

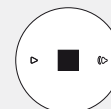



picosound

ICE RADIO 58-0401415 Designed radio ICE RADIO: with retro style knobs to select the station and control the volume, excl. 2xAAA batteries, handmade white ceramic body.

Packing: 24 pcs. | Size: 11,3x9,3x4,9cm | Branding: ☑ 70x20mm K2+H2+V2



SOUNDBALL 58-1101145 Mini radio SOUNDBALL: for mobile phone, iPod, MP3 player and PC, with integrated speaker and connection socket for MP3 players, 4,5 V adapter socket and 3,5mm socket plug, illuminated AM/FM tuning switch and on/off switch, batteries: 3xAAA (excl.).

Packing: 40 pcs. / 20 pcs. | Size: Ø9,5 cm | Branding: ☑ 25x10mm K2+H3



With integrated connection jack for MP3 player

BOOSTER 58-8106003 Interactive speaker BOOSTER with 2 side membranes for the best sound quality, rubberized rest area for a mobile phone or smartphone with volume icons – simply place it on the speaker and the music will be transmitted, AUX cable (approx. 50cm) to connect with PC or laptop, USB cable (approx. 62,5cm) to recharge the batteries, on and off switch on the back, 4 rubber feet.

Packing: 50 pcs. / 25 pcs. | Size: 13x6,9x4,5cm | Branding: ☑ 35x15mm L5+H5



Music through NFC technology



without decoration



BOOM LIGHT 58-8106010 Bluetooth speaker BOOM LIGHT: music output 5 Watt, frequency range: 50 Hz - 20 kHz, Bluetooth version 3.0, range approx. 10 m, to be paired with smartphone, iPhone, MP3 player, tablet etc., also connectable to devices such as PC and laptop through 3,5 mm line-in audio jack (length approx. 57 cm), incl. charging cable with USB plug (length approx. 71,5 cm), plays MP3 via slot for MicroSD card, lamp with touch function, 3 levels of brightness can be set, light power: 160 Lumen (1,6 Watt), powerful rechargeable battery with 1.800 mAh, control keys on base, non-slip coating on bottom and fold-out metal holder to hang up.

Packing: 12 pcs. / 6 pcs. | Size: Ø 12 x 12,5 cm |

Branding: ☑ 35 x 35 mm K1+H4+V1 | ☑ 30 x 30 mm L5+H4



NEW



*With touch function
to set brightness*



without decoration



MICROPHONE 58-8106008 Bluetooth speaker MICROPHONE in retro style: music output 3 Watt, with Bluetooth version 3.0, approx. 10 m range, to couple with cell phone, Bluetooth MP3 player, tablet etc., charging cable with USB connector included, integrated speakerphone, rechargeable battery with 600 mAh capacity, control buttons in stand.

Packing: 20 pcs. / 10 pcs. | Size: 18xØ9,2 cm | Branding:  25x15 mm L2+H4





BLUEDANCE 58-8106002 Mini speaker BLUEDANCE: for mobile phone, iPhone, MP3 player and PC, with blue light that dances to the rhythm of the music, frequency range: 150 Hz - 20 KHz, incl. cable with USB and line-out port 3,5 mm jack (length approx. 83 cm), with rechargeable built-in battery.

Packing: 100 pcs. / 25 pcs. | Size: Ø5x5,6 cm |

Branding:  160x30 mm LR3+H4 360° |  30x5 mm L2+H4



MUSH 58-8106009 Car Bluetooth speaker MUSH: music output: 3 Watt, with Bluetooth version 3.0, to be paired with mobile phone, Bluetooth-MP3-player, tablet etc., can be connected to external devices through 3,5 mm line-in audio jack (cable length: approx. 50 cm), slot for micro SD card, plays MP3s, with hands-free function, max. range: approx. 10 m, colourfully illuminated control keys, powerful battery, capacity: 600 mAh, USB charging cable with micro USB plug (length: approx. 50 cm) included, runtime: approx. 3 - 4 h, charging time: approx. 1 h, on / off switch at base, rubberized bottom with screw thread for suction cups (incl.) to attach to smooth surfaces, fancy metal casing.

Packing: 40 pcs. / 20 pcs. | Size: Ø7,4x6,7 cm | Branding:  20x25 mm K2+H4+V1 |  30x20 mm L1+H4



 **NEW**

With hands-free function





AUDIOMAX 58-8106004 Bluetooth stereo speaker AUDIOMAX: music output 2x3 Watt, with Bluetooth version 3.0, approx. 10 m range, to couple with cell phone, Bluetooth MP3 player, tablet etc., can also be connected to external devices such as PC and laptop, MP3 player, through line-in jack (3,5 mm), incl. charging cable with USB connection, plays MP3 also via slot for MicroSD card and USB stick (card and stick excl.), FM radio with autoscanner function and station memory presents, with speakerphone, integrated rechargeable battery with 1200 mAh capacity, control buttons at the top, 2 bottom rubber feet for best surface hold, metal plate on the front for your advertising, packed in gift box.

Packing: 30 pcs. / 10 pcs. | Size: 27,7 x 4,3 x 5,8 cm |

Branding: ☒ 35 x 10 mm K2+H6+V1 | ☒ 35 x 10 mm L2+H6

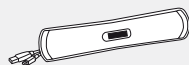

Adjustable microphone boom to optimally position microphone



ROSKILDE 58-1101880 Headset ROSKILDE: rotatable and adjustable microphone boom, soft padded headband and earpieces, volume control, 3,5 mm phone connector with cable (length approx. 2,2 m), frequency range: 8 - 22.000 Hz, sound pressure level: 100 dB.

Packing: 40 pcs. / 10 pcs. | Size: 21 x 6,8 x 8,5 cm | Branding: ☒ 40 x 6 mm K2+H4



VIBORG 58-1101897 On-ear headset VIBORG: soft padded headband and earpieces, built-in microphone at the volume control, 3,5 mm phone connector with cable (length approx. 2,2 m), frequency range: 8 - 22.000 Hz, sound pressure level: 100 dB.

Packing: 40 pcs. | Size: 18 x 17,5 x 7 cm | Branding: ☒ 30 x 5 mm K2+H4





58-8106005 black
58-8106006 white
58-8106007 red

WACKEN Headphones WACKEN: can be folded to save up space – soft padded headband and earphones, 3,5 mm stereo jack plug with cable (length approx. 155 cm), frequency range: 50 Hz - 20 kHz, volume: 110 dB +/- 3 dB.

Packing: 20 pcs. | Size: 18 x 18 x 6,5 cm | Branding:  15 x 15 / 30 x 15 mm K1+H4+V1



HURRICANE 58-1102260 On-ear headphones HURRICANE: cushioned earphones, volume control, 3,5 mm connector with cable (length approx. 2,2 m), frequency range: 8 - 22.000 Hz, sound pressure level: 100 dB, made of white plastic.

Packing: 40 pcs. | Size: 20 x 14,5 x 6 cm | Branding:  25 x 5 mm K2+H4

SOUNDCHECK 58-1103010 On-ear headphones SOUNDCHECK: cushioned earphones, adjustable headband with leather design, volume control, 3,5 mm phone connector with cable (length approx. 2,10 m), frequency range: 20 Hz - 20.000 Hz, sound pressure level: 105 dB.

Packing: 40 pcs. | Size: 20,0 x 15,2 x 7,1 cm | Branding:  35 x 15 mm K2+H4



Pleasure for eyes and ears

FREESPORT 58-8106001 Bluetooth headphones FREESPORT, splash-proof: ear cups with player function, runtime: approx. 8 hours, can be used as headset thanks to built-in microphone, Bluetooth version 2.0, with integrated battery, charging via incl. USB cable (length approx. 48 cm).

Packing: 20 pcs. | Size: 13 x 14 x 4,1 cm | Branding:  20 x 10 mm K2+H4



Turnable and foldable headphones



CONCERT 58-1103014 MP3 headphones CONCERT: rotatable and foldable headphones, cushioned earphones with player function and slot for micro SD card, memory capacity: up to 16 GB (excl.), supported music file format: MP3, frequency range: 20 Hz - 20.000 Hz, sound pressure level: 108 dB, battery chargeable via USB cable (length approx. 96 cm).

Packing: 40 pcs. | Size: 18 x 15 x 5,5 cm | Branding:  30 x 20 mm K2+H4



Padded headphones

Slot for mini SD card

Player function

With printing and engraving area



Brilliant performance Shown in the best light!

Let it shine. Our LED lights do not only look good, in terms of light output they are really small power packs. Reading light, solar lantern or flashlight ensure optimum illumination, wherever it is needed. The LEDs make it possible. In contrast to the light bulbs they are also much less sensitive to vibrations.

We from PiCOWORLD are specialised in bringing good things to light. You and your clients will be absolutely thrilled by the multifunctional picolux ideas!



2 removable torches (3x AAA batteries each, excl.)

highlight

TRANSFORMER 58-0600650 Camping lantern

TRANSFORMER: 2 light windows with integrated removable flashlights, retractable carrying handle, rechargeable via 230-volt outlet connector or 12-volt outlet (cigarette lighter), rubberized on/off switch.

Packing: 6 pcs. | Size: 25 x 12 cm | Branding: ☞ 30 x 10 mm K2+H5





Save energy
for a rainy day.

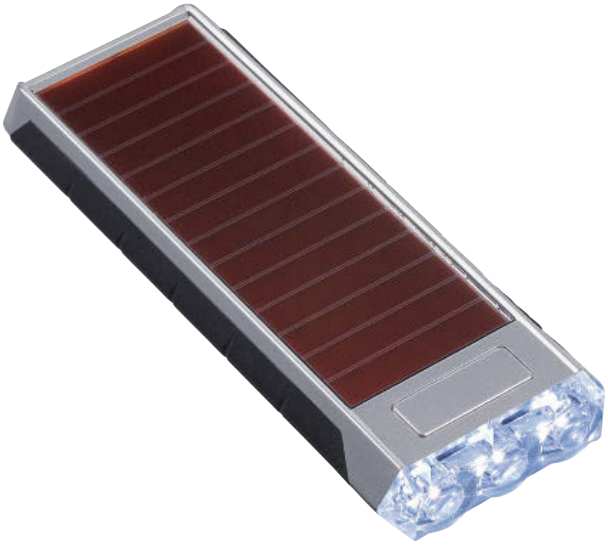

FLASHLIGHT 58-0600397 Dual-power torch FLASHLIGHT: with solar panel, 3 white LED lights and rechargeable lithium battery, plastic case.

Packing: 100 pcs. / 25 pcs. | Size: 11,5x4,5x1,5 cm | Branding: ☒ 15x5 mm K2+H2

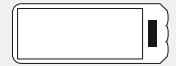

CORDLIGHT 58-0600497 Dual-power torch CORDLIGHT: with solar panel on top, dynamo function, 3 white LED lights, rechargeable lithium battery, plastic casing.

Packing: 100 pcs. / 25 pcs. | Size: 13x4,8x1,7 cm | Branding: ☒ 16x4 mm K2+H2



A reliable light source without batteries. A must-have for every driver!

ELECTRA 58-0600657 LED torch ELECTRA: handle can be unscrewed, rechargeable via 12-volt outlet (cigarette lighter), rubberized grip and on/off switch, robust stainless steel casing.

Packing: 50 pcs. | Size: 16x3,2cm | Branding: ☞ 20x10mm L2+H4

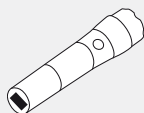

Rechargeable via 12 Volt adapter (cigarette lighter)



TURNLIGHT 58-0600590 Dual-power torch TURNLIGHT: with solar panel, dynamo lever, integrated rechargeable battery, 3 white LEDs, wrist strap, on/off switch on the side, plastic casing.

Packing: 120 pcs. / 60 pcs. | Size: 9x5x3cm | Branding: ☞ 20x5mm K2+H2



GÉNÉRATEUR 58-0600140 Dynamo torch GÉNÉRATEUR: dynamo lever, integrated rechargeable battery, 3 white LEDs, supporting loop, on/off switch at the side, made of high quality plastic.

Packing: 100 pcs. / 25 pcs. | Size: 7,4x4,4x2,7cm | Branding: ☞ 40x30mm K2+H4 | ☞ 50x30mm DP2+H2



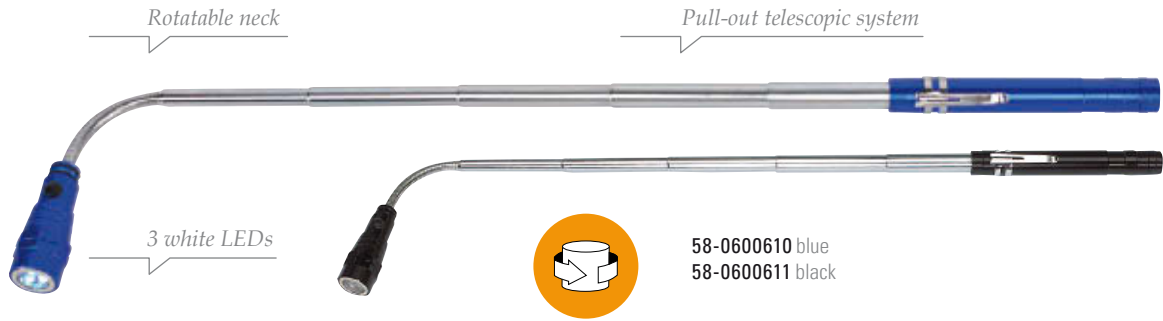

58-0600610 blue
58-0600611 black

REFLECT

LED torch REFLECT: telescoping neck extendable up to approx. 55 cm, rotating light, 3 white LEDs, magnetic ring, practical clip, rubberized on/off switch, aluminium casing, batteries: 4 x LR44 (incl.).

Packing: 100 pcs. / 25 pcs. | Size: Ø 2 x 16,8 cm | Branding: 30 x 4 mm K2+H4+V2 | 30 x 4 mm L2+H4 | 50 x 50 mm LR2+H4 360°



Rubber-coated ON/OFF button



With practical clip

With ring magnet



3 light modes



With magnet function

FLASH

58-8063002 LED torch FLASH: 7 white and 3 red LED lights in torch head, 18 white and 6 red LED lights in the handle – 3 light modes – with magnet at the torch end, rubber-coated on/off button, light and robust aluminium housing with nylon hand strap, batteries: 3x AAA (excl.).

Packing: 50 pcs. / 25 pcs. | Size: Ø 3,6 x 19,5 cm | Branding: 10 x 12 / 40 x 9 mm L2+H4

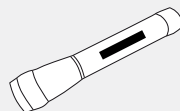



58-8064001 blue/black
58-8064002 red/black



Adjustable light cone for wide vision or for focussing

Be a guiding light



ZOOM LED torch ZOOM: with white light, adjustable light cone (wide angle or focused), shiny matt metal surface, rubberized on/off switch, with nylon supporting loop, aluminium lamp, batteries: 3 x AAA (excl.).

Packing: 50 pcs. / 25 pcs. | Size: Ø3 x 10,5-11,5 cm | Branding: 🚚 30 x 10 mm L2+H4

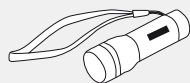

SHINING 58-8064003 LED torch SHINING: in robust aluminium body, rubberized on/off button, with clip to attach, batteries: 3 x LR44 (incl.).

Packing: 300 pcs. / 50 pcs. | Size: Ø2,2 x 7,2 cm | Branding: 🚚 17 x 7 mm K1+H2+V2 | 🚚 15 x 7 mm L1+H2

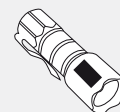

58-8041001 anthracite
58-8041002 turquoise
58-8041003 magenta
58-8041004 green



Rechargeable via USB



CARA Mini torch CARA: 6 strong white LED lights, rubberized on/off switch, with carabiner to attach to key ring, made of light aluminium, 4 button cells LR 44 (incl.).

Packing: 200 pcs. / 50 pcs. | Size: Ø2,5 x 5,7 cm | Branding: 🚚 20 x 5 mm L2+H4

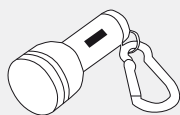

CHARGER 58-8041005 LED light CHARGER, chargeable: with key ring and integrated USB port for charging.

Packing: 400 pcs. / 200 pcs. | Size: Ø2,2 x 5,3 cm | Branding: 🚚 20 x 10 mm K1+H2 | 🚚 20 x 8 mm L4+H2

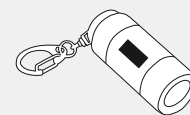



Tilting mechanism changes the lighting angle

Our PiCO reading lights are pretty bright.



Z-FLEX 58-8116001 USB desk lamp Z-FLEX, foldable: with 16 white LED lights, USB charging port, USB cable (length approx. 119 cm), on/off switch on the side.

Packing: 50 pcs. / 25 pcs. | Size: 18x4x2,5cm | Branding: ☒ 45x15mm K2+H5+V2 | ☒ 150x20mm DP2+H5

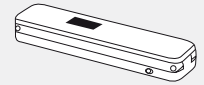

READ 58-1101120 LED lamp READ: provides ideal reading light, with bookmark function, made of flexible rubber and plastic.

Packing: 120 pcs. / 60 pcs. | Size: 20,2x4,1x1,4 cm | Branding: ☒ 30x20 mm K2+H4+V2





SWAN 58-8116003 Desk lamp SWAN: flexible swivel lighting arm with 14 LEDs, dimming function with 3 brightness levels, touch sensitive on/off, powered through a USB cable (length 120 cm), versatile in use thanks to integrated battery, power consumption up to 1,5 Watt, stand with rubber feet for best surface hold, packed in gift box.

Packing: 30 pcs. / 15 pcs. | Size: 11 x 10 x 28 cm | Branding: ☞ 30 x 16 mm K2+H6+V1 | ☞ 30 x 16 mm L4+H6



*Flexible and turnable
spotlight with 25 LEDs*



Dimmer function

ILLUMINATION 58-1103035 Desk lamp ILLUMINATION: individually adjustable pivot arm with 25 LEDs, continuously adjustable dimming, switched on/off by touching the base, power supply via 230 volt socket outlet and USB cable (length approx. 182 cm), rubberized surface.

Packing: 10 pcs. | Size: 38 x 11 x 11 cm |



Spark of inspiration Is it hot enough for you?



When was the last time you were actually in love? Our lighters will certainly light your fire. It's love at first sight! Even if you and your customers are not smoking, you will simply love our lighters. Wherever they are used, the heat is on.

Enjoy these innovative picoflam ideas that will spark off both you and your customers!



highlight

SKYSCRAPER 58-0400497 Stick lighter SKYSCRAPER: with child-proof lock, small control wheel to adjust the flame size, refillable gas filled, made of metal.

Packing: 200 pcs. | Size: 17,6x1,5x1,1 cm | Branding:  20x7 mm K2+H4+V2 |  20x8 mm L2+H4





pico**flame**

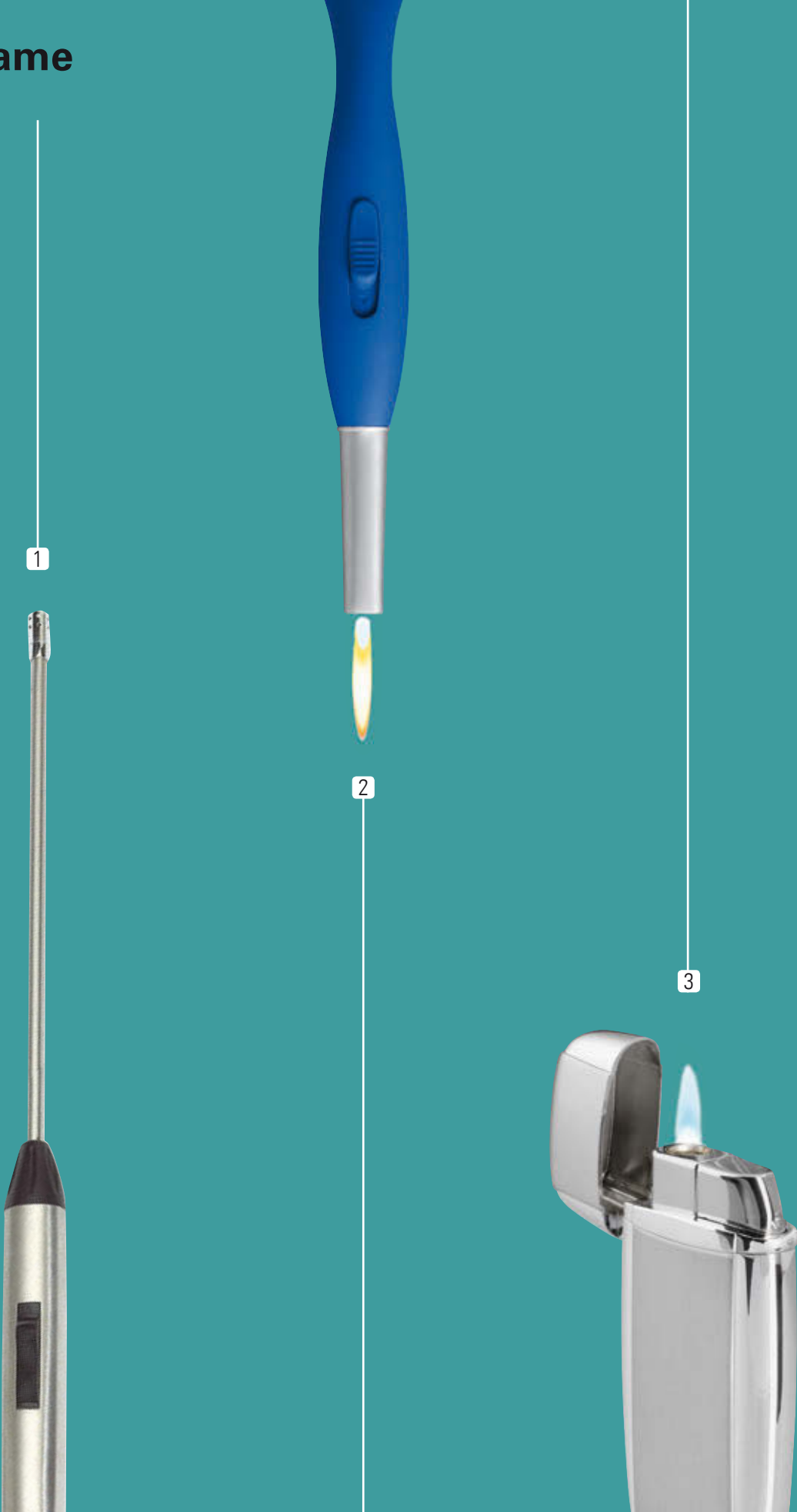

1

2

3



1 FIRESTARTER 58-8043000 Stick lighter FIRESTARTER: approx. 29 cm long neck, on/off switch with child protection, flame adjusting wheel, refillable gas filled, with instruction manual in different languages.

Packing: 50 pcs. | Size: 2,9x2,3x47,9 cm | Branding: ☹ 30x10 mm K2+H4+V1 | ⚡ 30x10 mm L2+H4

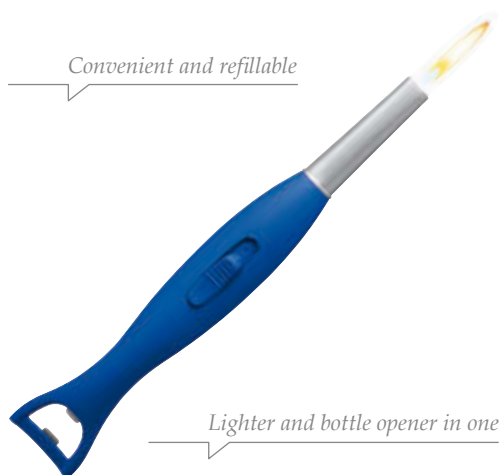

2 DOLPHIN 58-0400552 Stick lighter DOLPHIN: with integrated bottle opener, child-proof lock, small control wheel to adjust the flame size, refillable gas filled, made of plastic.

Packing: 100 pcs. | Size: 23x3,9x3 cm | Branding: ☹ 40x6 mm K2+H2+V2 | ⚡ 40x5 mm L2+H2



3 COMTE 58-0400567 Flameless piezo ignited lighter COMTE: high quality stainless steel surface, refillable gas filled, delivered in quality gift box.

Packing: 100 pcs. | Size: 7x3,3x1,1 cm | Branding: ☹ 40x15 mm K2+H2+V2 | ⚡ 40x25 mm L2+H2



Time off Relaxing, practical, and super active!

Everybody needs a portion of leisure. Simply no appointments, computer and cell phone are turned off. Start your barbecue and simply relax. Or meet up with friends for a picnic in the park. However you use your free time, just think of yourself. After all, less stress brings more joy to life!

The picoactive-program offers you a lot of variety in every season. We have put together ideas for you and your customers which simply invite you to unwind.



highlight

SOL-SPOT 58-0600437 Solar lamp SOL-SPOT: with bright LED light, integrated solar panel, robust plastic pole, shiny metal casing.

Packing: 30 pcs. | Size: 37 x 14 x 9 cm | Branding:  35x20 mm L2+H5

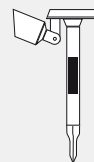



picoactive



The meat and potatoes of every barbecue.



GRILLINO 58-0600227 BBQ set GRILLINO, 3 pcs: fork, spatula and tongs made of stainless steel, all pcs with long handle, in aluminium cases with 2 snap locks, grip and metal plate for your advertisement.

Packing: 10 pcs. | Size: 38 x 11 x 9 cm | Branding:  60 x 30 mm L2+H4

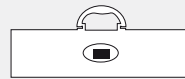

GRILLINATOR 58-0600230 BBQ set GRILLINATOR, 5 pcs: tongs, fork, spatula, salt and pepper shakers made of stainless steel, in handy nylon apron with integrated belt pouch and snap lock.

Packing: 10 pcs. | Size: 38 x 20 x 5,5 cm | Branding:  30 x 10 mm K2+H4+V2 |  80 x 80 mm T1+H6/T2+H6 |  10 x 10 mm L2+H4

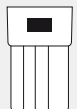

Let the barbecue season begin!



GRILLMEISTER 58-0600217 BBQ set GRILLMEISTER, made of stainless steel, 21 pcs: spatula, brush, knife, grill brush, fork, tongs and extra brush, salt and pepper shakers, 8 corn cob holders, 4 spits. Aluminium case with 2 snap locks, metal plate on case for your advertisement.

Packing: 5 pcs. | Size: 47,1 x 29 x 7,5 cm | Branding: 🗑️ 60 x 30 mm L2+H4

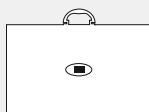

BBO-CADDY 58-0600290 BBQ set BBO-CADDY, 7 pcs: spatula, tongs, grill brush, brush and fork, plastic handles in the design of golf clubs, salt and pepper shakers in the design of golf balls, in caddy bag made of leatherette.

Packing: 6 pcs. | Size: 50 x 15 cm | Branding: 🗑️ 50 x 10 mm K2+H6+V2 | 🗑️ 50 x 30 mm T2+H6 | 🗑️ 50 x 30 mm L2+H4



COOLNESS 58-8065001 Picnic shoulder bag COOLNESS: with 3 pockets – 1 zip pocket, 1 aluminium isolation compartment for drinks and food, 1 extra zip compartment containing tongs, fork, spatula, salt and pepper shaker, bottle opener, cutting board and knife, made from 420D diamond and 840D jacquard. Packing: 6 pcs. | Size: approx. 30 x 17 x 40 cm | Branding:  120 x 40 mm T2+H4

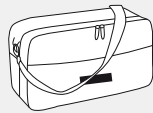

KILTY 58-0600503 Picnic blanket KILTY, foldable: warm top side made of 100% polyester, with stain-resistant underside made of PVC, incl. bag made of 600D polyester. Packing: 20 pcs. | Size: 38 x 28 x 5 cm / 150 x 117,5 cm | Branding:  80 x 80 mm T2+H2



Back side of blanket with stain-resistant PVC coating



SUMMERTIME 58-0600309 Picnic bag SUMMERTIME: made of polyester, for 2 persons, 2 zip pockets, one insulated compartment for drinks and food, second compartment includes 2 cups, salt and pepper shaker, 2 sets of cutlery, 2 plates, 1 cutting board, 1 bottle opener with cutters and corkscrew and 1 vacuum flask made of stainless steel. Packing: 6 pcs. | Size: 37 x 29 x 15 cm | Branding:  100 x 60 mm T2+H2



Suitable for 2 people



Enjoy life and be spontaneous.
How does that work? See for yourself!



Suitable for 4 people

4 PICKNICK 58-0600519 Picnic bag 4 PICKNICK for 4 persons: zip bags at the side filled with 4 plastic plates and glasses, metal spoons, forks and knives and napkins each, a waiter's knife, isolated zip cooler pocket for drinks and food, incl. picnic blanket (135 x 113 cm) with stain-resistant underside, adjustable and removable shoulder straps, 2 carrying handles.

Packing: 4 pcs. | Size: 45x25x24 cm |



Suitable for 4 people

COOLNESS 58-8065000 Picnic backpack COOLNESS for 4 people: contains 4 cloth napkins, plates, glasses, knives, forks, spoons each, 1 salt and pepper shaker, 2 bottle opener, 1 cutting board and knife, with aluminium isolation compartment for drinks and food, made from 420D diamond and 840 jacquard.

Packing: 6 pcs. | Size: approx. 30 x 17 x 40 cm | Branding:  100 x 30 mm T2+H4



FAXE 58-0200110 Shopping bag FAXE: with integrated cooler compartment, hook to hang on the trolley, can be rolled up to save space, polyester and aluminium lining on the inside.



Packing: 40 pcs. | Size: approx. 24-34 x 32,5-48 x 39 cm |
Branding:  80 x 80 mm T2+H2



without decoration



CUORE Shopping bag CUORE: with long handles, can be folded to form a heart shape, made of polyester.

Packing: 100 pcs. / 10 pcs. | Size: approx. 41 x 37 cm |
Branding:  30 x 25 mm T2+H2 |  30 x 25 mm S2+H2



58-0200140 black
58-0200141 red
58-0200142 blue



PERSONAL-ALARM 58-0400650 Key ring PERSONAL-ALARM: noisy audio warning sounds if you pull out the ring, handbag sized.

Packing: 100 pcs. | Size: 13,5 x 3,8 x 2,7 cm | Branding:  20 x 10 mm K2+H2





CASH CHECK 58-8041101 Money clip CASH CHECK with large advertising area, made of solid metal, packed in a gift box.

Packing: 240 pcs. /60 pcs. | Size: 5,8x3x1 cm | Branding: 📏 Ø22 mm D1+H2 | 📏 15x15 mm K1+H2+V2 | 📏 15x15 mm L1+H2



HOLD IT 58-0401477 Hand bag holder HOLD IT, foldable: felt underside provides secure hold on even surfaces, upper side ideal for placing your advertisement, made of shiny metal, delivered in case.

Packing: 250 pcs. /50 pcs. | Size: Ø4,5x0,8 cm | Branding: 📏 Ø25 mm K2+H2+V2 | 📏 Ø25 mm DP1+H2 | 📏 23x23 mm L1+H2



HOLD IT FOREVER 58-0401827 Hand bag holder HOLD IT FOREVER, foldable: with integrated mirror, rubberized underside provides secure hold on even surfaces, fastener with 2 magnets, upper side ideal for placing your advertisement, made of zinc cast and stainless steel, delivered in case.

Packing: 200 pcs. /50 pcs. | Size: Ø4,5x1,3 cm | Branding: 📏 Ø25 mm K2+H2+V2 | 📏 20x20 mm DP1+H2 | 📏 Ø25 mm L1+H2



 NEW





2 in 1



You can find additional powerbanks on pages 448-449.



HOT POWER 58-8105005 Powerbank HOT POWER with integrated heat source: suitable for smartphone, iPhone, and USB devices, incl. USB charging cable with micro-USB connector (length: approx. 30 cm), input power: 5V, 500 mA, output power: 5V, 1000 mA, charging time: approx. 4 h, capacity: 2200 mAh, high-performance lithium-ion battery, robust and lightweight aluminium casing – pocket heater gives heat of 45° C for approx. 3 h – simple to switch on and toggle powerbank and heater through single button.

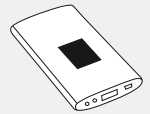

Packing: 80 pcs./20 pcs. | Size: 9,8x5,7 x 1,4 cm |
Branding:  70x25 mm K2+H4+V1 |  85x35 mm DP2+H4



Battery rechargeable via USB



HEAT 58-0600527 Hand warmer HEAT: provides heat up to 40° C upon pressing the button, rechargeable via USB cable (length approx. 32 cm), with integrated Li-Ion battery, made of plastic and aluminium.

Packing: 100 pcs./20 pcs. | Size: 9,1x4x0,8 cm |
Branding:  40x20 mm K2+H4+V1 |  90x35 mm DP2+H2 |  40x25 mm L2+H4



We won't leave you
and your customers
high and dry!

BOTTICELLO Drinking bottle BOTTICELLO, made of aluminium: with carabiner, capacity approx. 0,5 litre, incl. closable neoprene bag for cooling.
Packing: 40 pcs. / 20 pcs. | Size: Ø7,3x19,5 cm | Branding: ☒ 40x20 mm K2+H2+V2 | ☒ 40x20 mm T1+H4 | ☒ 225x60 mm LR3+H4 360° | ☒ 40x20 mm L2+H7



Capacity approx. 0,5 litres



58-0600342 blue/black
58-0600347 silver/black

58-0600450 black
58-0600451 red
58-0600452 blue



Capacity approx. 0,5 litres

58-8034000 white/silver
58-8034001 blue/silver
58-8034002 red/silver



Capacity approx. 450 ml

KEGEL Elegant vacuum flask KEGEL: capacity approx. 0,5 l, made of stainless steel.
Packing: 24 pcs. / 12 pcs. | Size: Ø7,5x25 cm | Branding: ☒ 30x30 mm K2+H4+V2 | ☒ 230x60 mm LR3+H4 360° | ☒ 28x28 mm L2+H4



WARMING UP Vacuum flask WARMING UP, double-walled: ideal for hot and cold drinks, cap with mouthpiece, coated bottom for good surface adhesion, capacity approx. 450 ml.
Packing: 48 pcs. | Size: Ø7,5x22,3 cm | Branding: ☒ 20x22 mm L2+H4 | ☒ 220x60 mm LR3+H4 360°



BRIGHTEAD 58-0600117 Head lamp BRIGHTEAD: with 5 LED lights, narrow and adjustable headband, weighs only 20 g, made of plastic, 5xLR41 batteries (incl.).

Packing: 200 pcs./10 pcs. | Size: 4,5x4x1,8cm | Branding: ☒ 20x20mm K2+H2



KILIMANDSCHARO 58-0600127 Head lamp KILIMANDSCHARO: with 12 LEDs, bulb lifetime of around 100.000 hours, adjustable lighting by turning on 4, 8 or 12 bulbs together with an intermittent option, adjustable headband for high wearing comfort, made of plastic, batteries: 3xAAA (excl.).

Packing: 100 pcs./10 pcs. | Size: 7x5,5x6,5cm | Branding: ☒ 6x8mm K2+H2

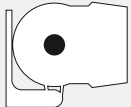

12 LED lights for 100.000 hours of durability

Intermittent lighting option

TREKKING 58-0600167 Compass TREKKING: magnified field for better reading of degrees as well as thread and magnifier with notch for direction finding, rotatable rose bedded in liquid, silver-coloured metal casing.



Packing: 100 pcs./20 pcs. | Size: 8x6x3 cm | Branding: ☒ 30x8mm K2+H2+V2 | ☒ 30x6mm L2+H2



Sharp tools to go

SAURUS 58-0300257 Multifunctional tool SAURUS, made of stainless steel: with foldable pair of pliers, knives, slotted and crosstip screwdrivers, saw, file, bottle opener and awl, comes in nylon pouch with Velcro closure and belt loop, total weight: approx. 265 g.

Packing: 40 pcs. /5 pcs. | Size: 10,6x5,2x1,6 cm |

Branding:  40x8 mm K2+H5+V1 |  40x8 mm L2+H5

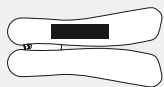

EXTREME 58-0300830 Pocket knife EXTREME: with 11 tool functions: knife, can opener, corkscrew, bottle opener, slotted and crosstip screwdrivers, scissors, wood saw, awl, file, fish knife, rubberized grip with two metal plates for your advertising, total weight: approx. 122 g.

Packing: 80 pcs. /20 pcs. | Size: 10x3,1x2,2 cm | Branding:  20x5 mm L2+H2

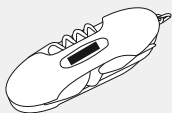

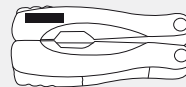

JOB SHOP 58-0300870 Multifunctional tool JOB SHOP: foldable universal pliers, aluminium grips in which stainless steel tools can be found: saw, file, slotted and crosstip screwdrivers, fish knife + scale (cm + inch), can opener, knife blade, awl, delivery in nylon pouch with Velcro closure and belt loop, total weight: approx. 240 g.

Packing: 40 pcs. /10 pcs. | Size: 10x4,5x2,0 cm | Branding:  20x5 mm L2+H5





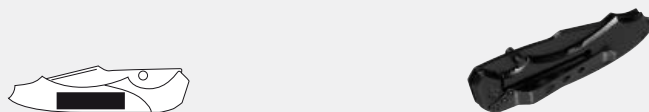
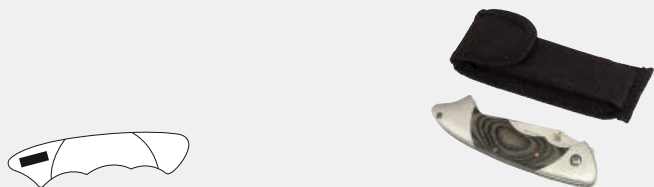

PRESTIGE 58-0300909 Pocket knife PRESTIGE, foldable: stainless steel blade, belt clip, smooth grip with grained wood application, incl. nylon bag with Velcro closure and belt loop, delivered in case, total weight: approx. 139 g.
 Packing: 96 pcs. / 12 pcs. | Size: 11,2x2,8x1,7 cm |
 Branding:  40x10 mm K2+H6+V1 |  15x5 mm L2+H6

BLACK-CUT 58-0300560 Pocket knife BLACK-CUT, foldable: steel blade with electrophoresis procedure finish, with clip and safety fuse, ergonomic grip, total weight: approx. 129 g.
 Packing: 48 pcs. / 12 pcs. | Size: 19,2x3,6x1,8 cm | Branding:  40x10 mm L2+H3



OUTBACK 58-0300810 Pocket knife OUTBACK, foldable: stainless steel blade, belt clip, slip-proof surface structure, total weight: approx. 109 g.
 Packing: 80 pcs. / 20 pcs. | Size: 11,0x3,0x1,9 cm | Branding:  30x4 mm L2+H4

MA-BU 58-0300542 Cutter knife MA-BU, foldable: easy to change manganese blade, incl. 5 spare blades in transparent box, ergonomic grip, belt clip, total weight: approx. 86 g.
 Packing: 100 pcs. / 25 pcs. | Size: 10x3,8x1,7 / 15,8x2,9x1,6 cm |
 Branding:  50x10 mm K2+H3+V1 |  50x13 mm L2+H3

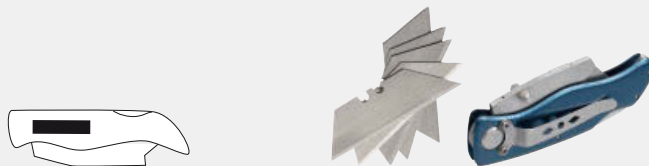
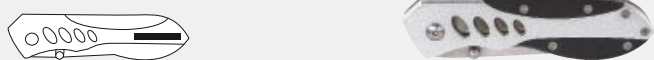



QUANTUM 58-8062000 Ultrasonic distance measurer QUANTUM: volume (m³) and area (m²) calculations, adds up to 20 length measurements, measurement range: approx. 0,13 m - 15 m, with digital display, on/off switch at the side and ergonomic grip, battery: 9 V monobloc battery (incl.).

Packing: 100 pcs. / 10 pcs. | Size: Ø5 x 13 cm | Branding: ☒ 30 x 10 mm K2+H4



INDEX 58-8062002 Measuring tape INDEX with finger protection, automatic, with stopper, individually adjusted belt clip for right- and left handed persons on the back, rubberized casing with metal plate for your advertising, 5 m.

Packing: 48 pcs. / 12 pcs. | Size: 10 x 8 x 4 cm | Branding: ☒ 30 x 35 mm K2+H4+V2 | ☒ 30 x 35 mm DP1+H2 | ☒ 30 x 35 mm L2+H4

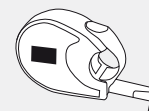

Robust 2m steel measuring tape

58-0300710 blue/silver
58-0300730 black/silver
58-0300750 red/silver



DISTANCE Measuring tape DISTANCE, 2 m: robust steel tape, scale in cm and ft, with carabiner for attachment to belt or keychain, printing and engraving area on both sides.

Packing: 200 pcs. / 50 pcs. | Size: 6,6 x 4,7 x 1,8 cm | Branding: ☒ 20 x 10 mm K1+H4



Good to go Comfort around the globe!



Anyone who travels a lot, knows how important it is to pack smartly. It starts with the manicure set and does not end with a hanger. And a luggage tag makes sure that the bag always finds its way back to the owner. Wherever your travels take you, we from PiCOWORLD offer you and your customers the best comfort.

Begin your next trip with our picotravel ideas. And don't forget: Make sure you use our logo services to bestow your personal and individualized return address on each and every product.



highlight

Y-POWER 58-8063001 USB car charger Y-POWER: permits simultaneous charging of two devices via cigarette lighter (12/24 V contact), two hubs, output power: 5 V, 2.000 mA, charges most current smartphones, digital cameras and MP3 players.

Packing: 200 pcs. / 50 pcs. | Size: 8,5 x 5 x 2 cm |
 Branding:  40 x 10 mm K1+H4 |  40 x 10 mm DP1+H2 |
 40 x 10 mm L4+H4



without decoration





picotravel

With extensive menu options

films at 120° angle



Picture perfect.

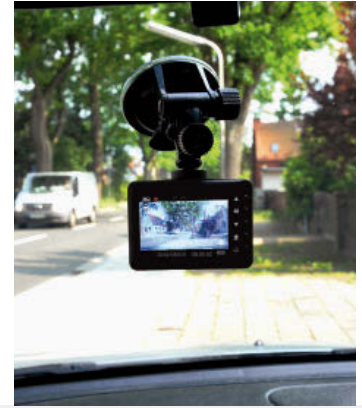

EVIDENCE 58-8107001 Digital car camera EVIDENCE for spectacular shots while driving: films night and day in full-HD quality – with continuous loop recording, motion sensor and photo function – equipped with microphone, TF memory card slot (supports memory cards up to 32 GB – memory card excl.), HDMI and USB 2.0 ports – includes suction cup to fix to the windscreen, 12- and 24-Volt power supply car adapter, with USB cable for data transmission, packed in giftbox.

Packing: 24 pcs. | Size: 7,6x5,6x2,2 cm | Branding:  25x3/25x5 mm K2+H6





With hands-free function

 NEW



MUSH 58-8106009 Car Bluetooth speaker MUSH: music output: 3 Watt, with Bluetooth version 3.0, to be paired with mobile phone, Bluetooth-MP3-player, tablet etc., can be connected to external devices through 3,5 mm line-in audio jack (cable length: approx. 50 cm), slot for micro SD card, plays MP3s, with hands-free function, max. range: approx. 10 m, colourfully illuminated control keys, powerful battery, capacity: 600 mAh, USB charging cable with micro USB plug (length: approx. 50 cm) included, runtime: approx. 3 - 4 h, charging time: approx. 1 h, on/off switch at base, rubberized bottom with screw thread for suction cups (incl.) to attach to smooth surfaces, fancy metal casing.

Packing: 40 pcs. / 20 pcs. | Size: Ø7,4x6,7 cm |

Branding:  20x25 mm K2+H4+V1 |  30x20 mm L1+H4



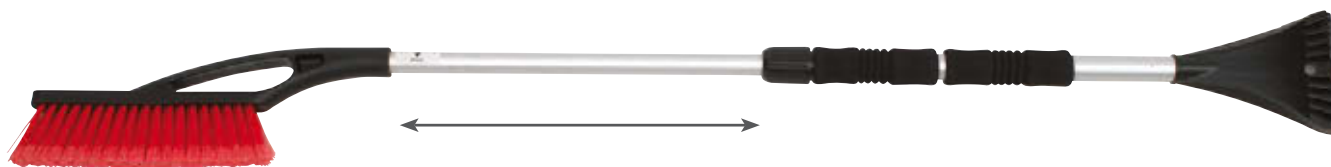

ARCTIC 58-0600660 Hand snow brush ARCTIC: with retractable telescope system, ice scraper on one side, hand brush on the other side, rubberized grips.

Packing: 20 pcs. | Size: 90x11 cm | Branding: ☒ 40x25 mm K2+H5



UNDER PRESSURE 58-0300670 Tire pressure measuring device UNDER PRESSURE: with LCD display, emergency hammer, integrated LED flashlight, 5 tools and a headlamp, made of plastic and stainless steel, delivered in box, battery: 1 x AAA (excl.).

Packing: 40 pcs. / 20 pcs. | Size: 16x7 x2,7 cm | Branding: ☒ 30x20 mm K2+H3+V2 | ☒ 30x20 mm L2+H3

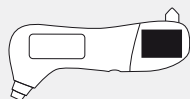

SOLID 58-0800207 Hanger SOLID: foldable to save space, made of aluminium, delivered in case with fitting protection cover.

Packing: 100 pcs. / 50 pcs. | Size: 13,2x5x1,1 cm | Branding: ☒ 30x15 mm L2+H3



We will spread your good reputation all over the world.



TAKE OFF 58-0401447 Luggage tag TAKE OFF: with address section, robust metal wire with secure lock, made of aluminium.
 Packing: 100 pcs./20 pcs. | Size: 9x3x0,9 cm | Branding: ☒ 50x10 mm K2+H3+V2 | ☑ 40x10 mm L1+H3

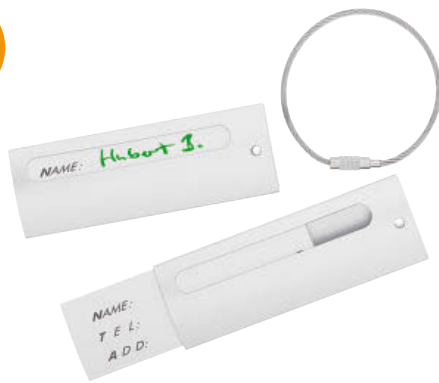

NOMINAL 58-0200017 Luggage tag NOMINAL: includes address card, robust metal wire with secure lock, made of aluminium.
 Packing: 500 pcs./100 pcs. | Size: 8,5x3x0,9 cm | Branding: ☒ 35x8 mm K1+H3+V2 | ☒ 35x8 mm DP1+H2 | ☑ 35x8 mm L1+H3



TRAVELLER 58-0402050 Luggage tag TRAVELLER: with integrated address field, robust metal wire with secure lock, made of stainless steel.
 Packing: 400 pcs./100 pcs. | Size: 8x4,1 cm | Branding: ☒ 50x15 mm DP1+H2 | ☑ 50x15 mm L1+H6





CARL 58-0800307 Luggage scale CARL: with LED display in handle, shows weight of suitcase in 0,01 kg steps, with hold and tare function, maximum weight: 50 kg - accurate to approx. 30 g, strong nylon loop with robust plastic grip, delivered in case.

Packing: 100 pcs. / 20 pcs. | Size: 15x8x3,5cm | Branding: ☒ 20x10mm K2+H4



FELIX 58-0800310 Toilet bag FELIX: with zip and carrying handle, 2 zip pockets inside, removable metal hook to hang it, made of water-repellent material - high quality artificial leather and polyester.

Packing: 10 pcs. | Size: 29x16x13 cm | Branding: ☒ 30x10mm L2+H2





58-0800351 red
58-0800352 blue



BEAUTY Manicure set BEAUTY: with foldable mirror, 5 make-up tools and 4 manicure tools (scissors, nail clipper, nail file, tweezers), designed like a handbag, made of PU, comes in a stylish box.

Packing: 60 pcs. /30 pcs. | Size: 12 x 13 x 3 cm | Branding: ☞ 60x25 mm K2+H3



58-0800331 red/silver
58-0800332 blue/silver
58-0800333 green/silver



LOOK AT ME Pocket mirror LOOK AT ME: aluminium on the inside, leatherette on the outside, with magnetic clip, comes in stylish box.

Packing: 100 pcs. /50 pcs. | Size: 6 x 6 x 1 cm | Branding: ☞ 30 x 30 mm K2+H3 | ☞ 30 x 30 mm DP1+H2



When betting on our items, there is no need to bite your nails!



NYKÖPING 58-0800170 Manicure set NYKÖPING, 5 pcs: consists of nail scissors, nail clipper, nail file, nail pliers and tweezers, in croc-look leatherette case with logo plate for your advertisement.

Packing: 80 pcs. / 10 pcs. | Size: 7,8x12,1x2 cm | Branding: 🗑️ 25x8 mm L2+H4

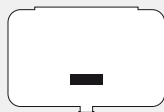

PICOCARE 58-0800328 Manicure set PICOCARE, 4 pcs: scissors, tweezers, nail clipper and nail file made of stainless steel, EVA foam on the inside - prevents shifting and rattling, in ultra-flat slipcase made of shiny aluminium.

Packing: 24 pcs. | Size: 10,7x8x1,5 cm | Branding: 🗑️ 60x15 mm K2+H4+V2 | 🗑️ 60x30 mm L2+H2

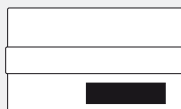

In attachments Small but great!

You know the sentence: „Good things come in small packages.“ Then you must also know, that it is the small things that makes people smile. A keyring doesn't just open doors, they also open the heart of customers and show appreciation. Give it a try!

Our picostyle key rings proves themselves as practical companions, which emphasise personality and style. Let our key rings convince you!

With integrated whistle



highlight

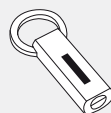

WHISTLE 58-0401890 Key ring WHISTLE: with extendable key ring and integrated whistle, made of matt polished stainless steel.

Packing: 200 pcs. / 50 pcs. | Size: 4,1 x 1,1 x 1,5 cm | Branding:  30 x 5 mm L1+H4





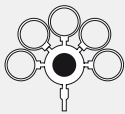

picostyle

DISQUE 58-0400077 Metal key ring DISQUE: with five removable rings.
 Packing: 250 pcs. /50 pcs. | Size: Ø2,5x10x1 cm | Branding:  Ø15 mm K2+H4+V2 |  8x8 mm L1+H4



PITO 58-0400207 Key ring PITO: with a whistle, made of metal and plastic, high gloss chrome-plated key ring.
 Packing: 250 pcs. /50 pcs. | Size: 8x3,5x1 cm | Branding:  25x15 mm K2+H2+V2 |  30x15 mm L1+H2



NOTEBOOK 58-0401697 Metal key holder NOTEBOOK, foldable: with 3 key rings and integrated picture frame, with magnetic closure.
 Packing: 200 pcs. /50 pcs. | Size: 4x4,5x0,6 cm | Branding:  25x15 mm K2+H2+V1 |  30x15 mm L1+H2

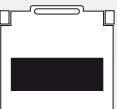

Advertising on key chains pays off!



COINLESS 58-0400167 Key ring COINLESS: with integrated EURO-sized chip, made of stainless steel.

Packing: 300 pcs. / 50 pcs. | Size: 9,5x3,2x0,5 cm |

Branding: ☞ 20x10 mm K2+H4+V2 | ☞ 16x4 mm L1+H4



CARRY 58-0401717 Metal key holder CARRY: shopping bag design, with integrated EURO-sized chip, key ring with carabiner.

Packing: 250 pcs. / 50 pcs. | Size: 10,5x3,2x0,9 cm |

Branding: ☞ 25x20 mm K2+H2+V2 | ☞ 25x23 mm L1+H2



CHAMBA 58-0401787 Metal key chain CHAMBA: designed in the shape of a pig, with integrated EURO-sized chip, space for your advertisement on pendant and chip.

Packing: 250 pcs. / 50 pcs. | Size: 11 x 3,5 x 0,6 cm |

Branding: ☞ 25 x 10 mm K2+H4+V2 | ☞ 20 x 10 mm L1+H4



1



2



3



4



5



6







*In exclusive
PiCOWORLD-design*



*In exclusive
PiCOWORLD-design*

1 PESCADO 58-0401767 Key chain PESCADO: designed in the shape of a fish, steel wire with PiCOWORLD quick fastener, shiny chrome finish.

Packing: 300 pcs. / 50 pcs. | Size: 4,1x2x0,7 cm |

Branding:  20x10 mm K2+H4+V2 |  10x6 mm L1+H4



2 PAJARO 58-0401777 Key ring PAJARO: designed in the shape of a bird, steel wire with PiCOWORLD quick fastener, shiny chrome finish.

Packing: 300 pcs. / 50 pcs. | Size: 4,1x2x0,7 cm | Branding:  10x6 mm K2+H4+V2 |

 10x6 mm L1+H4



3 GATO 58-0400117 Key ring GATO: designed in the shape of a cat, steel cable with secure snap-in mechanism, made of high gloss chrome-plated metal.

Packing: 300 pcs. / 50 pcs. | Size: 4,3x2x0,7 cm | Branding:  10x6 mm K2+H4+V2 |

 10x6 mm L1+H4



4 PERRO 58-0400107 Key ring PERRO: designed in the shape of a dog, steel cable with snap-in mechanism, made of high gloss chrome-plated metal.



Packing: 300 pcs. / 50 pcs. | Size: 4x2,2x0,7 cm | Branding:  10x6 mm K2+H4+V2 |

 10x6 mm L1+H2



5 FLY AWAY 58-0401177 Key ring FLY AWAY: with 3 removable rings, plane has to be turned to open the ring, rubberized bottom side, made of high gloss chrome-plated metal.

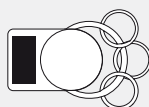

Packing: 250 pcs. / 50 pcs. | Size: 5,5x3,4x1,4 cm |

Branding:  20x5 mm K2+H2+V2 |  15x10 mm L1+H2



6 SPEED 58-0401237 Key ring SPEED: designed in the shape of an automatic gearshift, use lever to open lock, made of metal.

Packing: 200 pcs. / 50 pcs. | Size: 5,4x3,1x1,4 cm |

Branding:  25x8 mm K2+H2+V2 |  25x12 mm L1+H2



Keep your keys on a leash!



DOGGY 58-0402065 Key finder DOGGY: barks and flashes lights - activated by clapping your hands – with rubberized leash to attach to keys, batteries: 3 x AG13/LR44 (incl.).

Packing: 200 pcs. / 20 pcs. | Size: 6x5x2,3 cm | Branding: ☒ 15x5 mm K1+H3

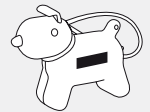

HIGHWAY 58-0400197 Key ring HIGHWAY: designed in the shape of a race car, with two bright LED lights, made of metal.

Packing: 200 pcs. / 50 pcs. | Size: 9x3,3x0,9 cm | Branding: ☒ 31x9 mm L1+H2





FORTUNA 58-0401737 Key holder FORTUNA: separable chrome-plated metal dice, with space on dice for your advertisement.

Packing: 200 pcs. / 50 pcs. | Size: 8,6x2 cm | Branding: 🗑️ 10x10 mm L1+H2



CARDS 58-0400187 Key ring CARDS: untwist ring to attach key, made of chrome-plated metal.

Packing: 250 pcs. / 50 pcs. | Size: 7,7x5,1x0,4 cm | Branding: 🗑️ 30x15 mm L1+H2



HEART 58-0401450 Metal key ring HEART: designed in the shape of a heart, with practical snap lock and 3 removable rings.

Packing: 250 pcs. / 50 pcs. | Size: 4,1x4,1x0,6 cm |

Branding: 🗑️ 20x10 mm K2+H2+V2 | 🗑️ 20x10 mm L1+H2



The best gifts
come from
the heart.



LOVELY 58-0401900 Key ring LOVELY: designed in the shape of a heart, made of highly polished stainless steel.

Packing: 200 pcs. / 50 pcs. | Size: 3,9x4x0,3 cm | Branding: 🗑️ 20x10 mm L1+H2





Hold the key to advertisement!





BELTO 58-0401260 Key ring BELTO: designed in the shape of a belt buckle, with black hanger made of solid polyurethane, secure metal lock.

Packing: 200 pcs. / 50 pcs. | Size: 8,5x2x0,7 cm |

Branding:  25x12 mm K2+H2+V2 |  25x12 mm L1+H2





ESTRELLA 58-0401810 Key chain ESTRELLA: designed in the shape of a star, leatherette with contrasting white stitches and engraving plate, metal key ring.

Packing: 250 pcs. / 50 pcs. | Size: 10x5x0,5 cm | Branding:  Ø12 mm K2+H2+V2 |  10x10 mm L1+H2



LABEL 58-0401700 Key holder LABEL: in real leatherette with contrasting white stitches and engraving plates with zinc alloy, key ring is made of metal.

Packing: 250 pcs. / 50 pcs. | Size: 10,7x3,3x0,7 cm |

Branding:  25x10 mm K2+H2+V2 |  30x10 mm L1+H2



Refined with a CRYSTALLIZED™-
Swarovski Element





KAI TAK 58-0401430 Key ring KAI TAK: with 2 key rings, high quality leatherette and one CRYSTALLIZED™-Swarovski Element – pendant can be extended.

Packing: 250 pcs. / 50 pcs. | Size: 6,2x3,2x1,9 cm | Branding:  13x10 mm L1+H2



WITH LOVE 58-8041102 Key finder WITH LOVE: with shiny red heart clip and key ring to attach the key, made of zinc alloy and stainless steel.

Packing: 250 pcs. / 50 pcs. | Size: 11x2,8x2,2 cm |

Branding:  Ø 15 mm K2+H4+V1 |  20x10 mm L1+H4





without decoration



LENI 58-0401837 Key finder LENI: with carabiner to attach key and nice engraving plate, made of zinc cast and stainless steel, delivered in gift box.

Packing: 250 pcs. / 50 pcs. | Size: 12,5x3,5x1,5 cm |

Branding:  Ø 20 mm K2+H3+V2 |  20x20 mm L1+H3



Tastefully Excellent taste on show!



As you know, there is no accounting for taste. We are inspired by looking at the wine opener, cheese board and pepper mill. The stylish household products in noble design simply bring good taste into your kitchen. A feast for the eyes.

Enjoy the selection and let yourself be seduced by our appetizing picohome ideas. On the following pages you and your customers will find the right thing for every taste.



highlight

KITCHEN-EGG 58-0300487 Timer KITCHEN-EGG: 60-minute-scale, stylish shape of an egg, with black numbers on brushed metal.

Packing: 100 pcs./25 pcs. | Size: Ø6x7,5 cm | Branding:  20x12 mm K2+H3+V2 |  20x8 mm L2+H3







With alternating colours to visualize remaining time



These reliable timekeepers make your business tick.

DORI 58-0300597 Kitchen timer DORI, made of stainless steel: with LED indicator that changes colour to show the remaining time, green > 10 min, yellow 10 - 5 min, red < 5 min, on/off switch for the light, batteries: 2 x AA (excl.).

Packing: 40 pcs./20 pcs. | Size: Ø8x5 cm | Branding: ☞ Ø40 mm K2+H3 | ☞ Ø40 mm L2+H3



without decoration

 NEW

UFO 58-0300397 Kitchentimer UFO: 60-minute-scale, made of brush-finished metal.

Packing: 100 pcs./50 pcs. | Size: Ø7 x 4 cm | Branding: ☞ 25 x 15 mm K2+H2+V2 | ☞ 25 x 15 mm L2+H2



TOUCH'N'COOK 58-8036002 Kitchen timer

TOUCH'N'COOK: displays up to 99 min/59 sec, tone after set time expires, simple operation of touch buttons on display, with magnet and put-up hinge on the back side.

Packing: 120 pcs./60 pcs. | Size: 7,6x7,6x2,5 cm | Branding: ☞ 25x3 mm K1+H2



Hot! With this artful design, tea and coffee drinkers show good taste.

ENJOY 58-0300647 Hot chocolate and cappuccino shaker set ENJOY: includes shaker, heart and star stencils, made of stainless steel.

Packing: 48 pcs. | Size: 9xØ4 cm (dispenser)/Ø6,5cm (pattern) |
Branding: ☰ 60x15 mm K2+H3+V2 | ☞ 120x70 mm LR3+H3 360° |
☞ 60x15 mm L2+H4



without decoration



TEA + HEART 58-0300655 Tea set TEA + HEART: stainless steel tea ball and heart-shaped ceramic bowl.

Packing: 48 pcs. | Size: 5,5x4x1,5 cm (Tea infuser)/8x7,5x3 cm (Bowl) |
Branding: ☰ 25x20 mm K2+H3+V2

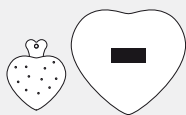

without decoration



SALT N' PEPPER 58-0300615 Salt and pepper mill
 SALT N' PEPPER: with robust ceramic mill and window, operated by pushing a button, delivered in case, batteries: 6 x AA (excl.).
 Packing: 20 pcs. | Size: 21,6xØ6,8 cm | Branding:  30x20 mm K2+H4+V1

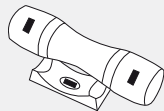

High-quality, robust ceramic grinder

KOPENHAGEN 58-0300510 Salt and pepper mill
 KOPENHAGEN: with window and ceramic grinder - 5 grinder levels selectable, incl. elegant storage tray with metal plate, made of plastic and brushed stainless steel.
 Packing: 24 pcs. | Size: 22,3x6,3x5,5 cm | Branding:  30x10 mm L2+H3



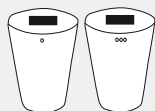

OSLO 58-0300537 Salt and pepper set OSLO: made of polished metal.
 Packing: 50 pcs. / 10 pcs. | Size: 4,5x4,5x6 cm |
 Branding:  90x35 mm LR3+H2 360° |  Ø24 mm L1+H2





The eye must be pleased.

BAMBOO-ROUND 58-0300469 Chopping board
BAMBOO-ROUND: with handy waste drain along the side, made from sturdy bamboo.

Packing: 10 pcs. | Size: 30 x 20 x 2 cm | Branding:  40 x 10 mm K2+H4+V1 |  200 x 200 mm DP2+H2 |  40 x 10 mm L2+H4



BAMBOO-GRIP 58-0300449 Chopping board BAMBOO-GRIP:
with handy metal handle, made from sturdy bamboo.



Packing: 10 pcs. | Size: 43 x 26 x 2 cm | Branding:  40 x 30 mm K2+H4+V1 |  200 x 200 mm DP2+H2 |  40 x 30 mm L2+H4



*With twist mechanism
to open and close*



KAAS 58-0300609 Cheese set KAAS: 2 cheese knives and a fork, made of stainless steel with wooden grips, in bamboo box with slideable lid that can be used as a chopping board, delivered in a black box.

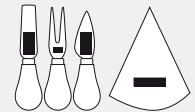

Packing: 24 pcs. | Size: 22,5x20x3 cm | Branding:  60x20 mm K2+H4 |  70x20 mm K2+H4+V2 |  70x20 mm L2+H4



*With protection covers
for the blades*



CERA-TRIO 58-8031000 Ceramic knife set CERA-TRIO, 3 pcs: comprises bread knife, all-round knife and peeler, with rust-proof ceramic blades and plastic grips, delivered in gift box.

Packing: 10 pcs. | Size: 30,5x22x2,8cm | Branding:  70x30 mm DP2+H2 |  35x10 mm L2+H4

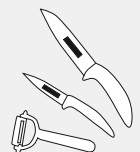



A high-class dinner calls for only the best ingredients!



*High-quality, rust-free
and robust ceramic blade*



CARBO-CUT 58-0300660 Ceramic knife CARBO-CUT: rust-proof ceramic blade and plastic handle with carbon finish, comes in stylish case.
Packing: 30 pcs. | Size: 24 x 3 x 2 cm | Branding:  30 x 10 mm K2+H3+V2 |  80 x 30 mm DP2+H2 |  30 x 10 mm L2+H3



THANKSGIVING 58-0300587 Knife set THANKSGIVING, 3 pcs: knife, poultry shears and fork made from high quality stainless steel, in aluminium suitcase with latch and engraving plate.
Packing: 16 pcs. | Size: 33,6 x 14 x 3,5 cm | Branding:  50 x 30 mm L2+H2





With touch buttons



58-0300500 black
58-0300501 red
58-0300505 white



Design award 2009!



without decoration



TIME Digital kitchen scale TIME: with glass surface and touch panels, displays weight in kg, g, oz and lbs (can be set on the backside), analogue clock, weighs max. 3 kg, wall holder, made of plastic and glass, batteries: 3 x AAA (excl.), 1 x LR44 (incl.).



Packing: 6 pcs. | Size: Ø 20 x 2 cm | Branding:  40 x 20 mm K2+H3+V2 |  40 x 20 mm DP1+H2



Platform made of 300° heat resistant, scratch-proof safety glass



i-CONTROL 58-8036000 Digital kitchen scale i-CONTROL: illuminated LCD display, weight displayed in kg, g, oz and lbs, accurate to 1 g, weighs max. 3 kg, with hold and tare functions, glass surface heat resistant up to 300°, batteries: 3 x AAA (excl.).

Packing: 20 pcs. / 10 pcs. | Size: 23 x 16,2 cm | Branding:  40 x 30 mm K2+H6+V2 |  60 x 50 mm DP2+H2

COOKING-SCALE 58-0300310 Digital kitchen scale COOKING-SCALE: displays weight in kg, g, oz and lbs, accurate to 1 g, weighs max. 3 kg, made of glass and plastic, batteries: 2 x AAA (excl.).

Packing: 10 pcs. | Size: 21 x 17 x 3,3 cm | Branding:  30 x 10 mm K2+H4+V2

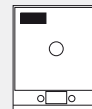

without decoration

58-0300470 silver/black
58-0300477 silver



No nut is too
tough to crack!

CRACK-IT Nutcracker CRACK-IT: incl. collecting pan with integrated fixture for the nutcracker, made of metal and plastic.

Packing: 20 pcs. | Size: Ø 16x20,5 cm | Branding: ☞ 40x10 mm K2+H3+V1 |
☞ 28x9 mm L2+H3



CRÈME BRÛLÉE 58-8043001 Flambé burner CRÈME BRÛLÉE – ideal to caramelize desserts: with instruction manual, filled with gas and easy to refill.



Packing: 100 pcs. | Size: Ø 2,5x19 cm | Branding: ☞ 40x10 mm K2+H4+V1 |
☞ 40x10 mm L2+H4





Good wines deserve to be presented well. Let's drink to that!

HELIX 58-0300557 Designer wine holder HELIX: robust quality, made of highly polished stainless steel.

Packing: 45 pcs. | Size: 15x15x8 cm | Branding:  40x30 mm K2+H4+V2 |  45x30 mm L2+H4





STEADY 58-0300907 Bottle holder STEADY: with convenient handle for unerring pouring, velvet velour inside, outside made of highly polished stainless steel.

Packing: 24 pcs. | Size: 23,5x7,5 cm | Branding:  50x10 mm L2+H4



COOL-IT 58-0300420 Designer bottle cooler COOL-IT: for wine and champagne bottles, with lid, made of solid plastic and brushed metal.

Packing: 18 pcs. | Size: 25,5x12,5x12 cm | Branding:  30x20 mm K2+H3+V2 |  30x20 mm L2+H3



There are many occasions in life to celebrate and raise the glass in success.

PLEASURE 58-0300690 Wine set PLEASURE: wine thermometer, two drip rings, corkscrew, metal spout, bottle cap – made of stainless steel, includes elegant wooden stand, delivered in black box.

Packing: 24 pcs. | Size: 19,5x6x6 cm | Branding: ☑ 40x20 mm K2+H4



DAISY 58-0300380 Corkscrew DAISY: easy handling thanks to lever mechanism, chrome-plated with non-slip rubber parts.

Packing: 48 pcs. / 6 pcs. | Size: 17,5x7,5x5 cm | Branding: ☑ 20x10 mm L2+H2



SERVICE 58-0300900 Waiter's knife SERVICE: with corkscrew, bottle opener and seal cutter, easy opening thanks to 2-stage lever mechanism, delivery in black box.

Packing: 100 pcs. | Size: 14x3x1,2 cm | Branding: ☑ 30x5 mm K2+H4



dries and warms the footwear up to the toes



DRY FEET 58-8036001 Shoe dryer DRYFEET: with automatic temperature control, 230 Volt socket connection, cable (length approx. 140cm).
Packing: 20 pcs. | Size: 14,2x5,4x3,1 cm | Branding: ☐ 30x7 mm K2+H5+V1

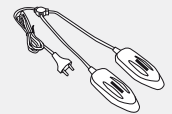

CLASSIC 58-0800120 Shoe cleaning set CLASSIC: includes 1 colourless polish, 2 different wooden shoe brushes, 1 shoehorn, 1 polishing cloth and 1 sponge to apply shoe polish, in leatherette case with button and white stitching.
Packing: 20 pcs. / 10 pcs. | Size: 16x6 cm | Branding: ☐ 70x10 mm T1+H3



Never lose sight of
your glasses again.



HANG-UP 58-8090001 Jewellery holder HANG-UP, figure made of polyresin with iron frame for hanging necklaces, rings and earrings, weight: approx. 79 g.

Packing: 36 pcs. | Size: Ø4,5x15 cm | Branding: ☒ 35x15 mm K2+H4+V1 | ☒ 35x15 mm L4+H4



SAFE 58-8090000 Eyeglasses holder SAFE, made of polyresin in form of a nose, weight: approx. 185 g – ideal for safe storage of glasses.

Packing: 36 pcs. | Size: 5,1 x 5,7 x 12,1 cm | Branding: ☒ 12x6 mm K2+H4+V1 | ☒ 12x6 mm L4+H4



All fun and games Jump for joy and play!

There are countless computer games. Just take a guess: what games are the most popular? Hard to believe but true – board games and parlour games! All this, even though the end of good old board games has already been presumed in the age of Internet. Long last the play passion!

Whichever game type you are, we have the right PiCOWORLD game for all! And the best of all? All our picogames can easily be taken along on trips, providing you and your customers with fun and relaxation on the way.



With rollable green (189 x 23 cm)

highlight

HOLE-IN-ONE 58-0500170 Golf set HOLE-IN-ONE: 3 pcs metal club with rubberized grip can be screwed together, rollable green (189x23 cm) with training hole, real golf ball, in leatherette golf bag - weighs less than 1 kg.

Packing: 10 pcs. | Size: 17 x 10 x 39cm |

Branding:  50x10mm K1+H3





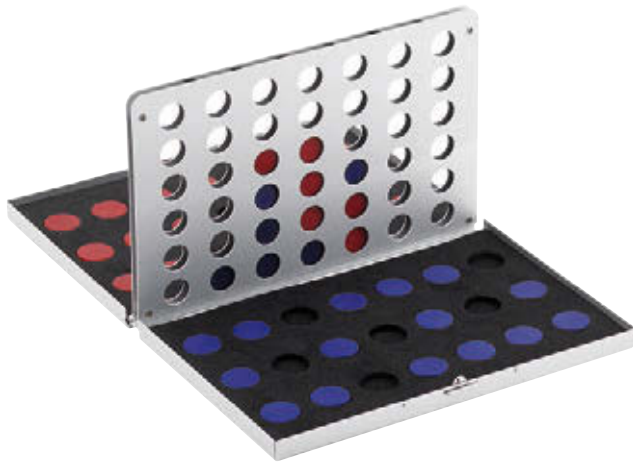

picogame

You and your customers will play in the upper league!



TETRADE 58-0500067 Arcade game TETRADE: arrangeable aluminium playing area and colourful gaming pieces made of plastic, in handy aluminium box.

Packing: 50 pcs. / 10 pcs. | Size: 17 x 10,5 x 2 cm |
 Branding:  70x20 mm K2+H4+V1 |  160x100 mm DP2+H2 |
 100x15 mm L2+H4



Game mat with 6 sensor areas

8 IN 1 GAME 58-0500265 Video game console 8 IN 1 GAME: 8 games (hurdle race, marathon, skiing, soccer, aerobics, skipping rope, hammer throwing and playing marbles), play rug with 6 sensor areas, BMI index display before game starts, displays burnt calories, excl. 4 x AA batteries.

Packing: 10 pcs. | Size: 10 x 15 x 3,3 cm / 68 x 38 cm | Branding:  70x15 mm K2+H4





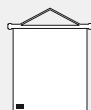

501 58-0500140 Dart game 501: stable unrollable cardboard, front and back side can be used to play, with 6 magnetic darts, can be hung up on plastic pole.
Packing: 12 pcs. | Size: 47,3x41 cm | Branding:  80x60 mm T1+H3



BEND 58-8051000 Dice game BEND: consists of 6 wooden pieces, made of different coloured bamboo, delivered in box, incl. answer sheet.
Packing: 80 pcs. /20 pcs. | Size: 7,5x7,5x7,5 cm | Branding:  20x10 mm K2+H4



UP + DOWN 58-8053000 Yo-yo UP + DOWN: with smooth metal movement, shows a star from the side, instruction manual for various games.
Packing: 150 pcs. /50 pcs. | Size: Ø5,6x3,5 cm | Branding:  20x10 mm DP1+H2 |  20x10 mm L2+H4

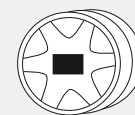



Your special service advantages!

Your special service advantages! "Excellent quality, reliable, on-time delivery. All at outstanding conditions!" That is our philosophy. And how can we live up to these ideals? With first-class service, of course!

- You can always count on our quick, reliable and on-time delivery!
- Before we add a product to our portfolio, we inspect it minutely in terms of its quality and function!
- Based on our experience and the right contacts, we can even make challenging custom-made products available to you at any time!
- You can order a sample of any product in advance – guaranteeing you a risk-free purchase!
- You can individualize every product with your name or logo – making the products even more unique!
- High-quality ideas deserve high-quality packaging: That is why we deliver many products in a stylish gift box!

Print code legend

The print codes at the end of the product descriptions give you details regarding the printing process and the cost of printing names or logos.

- K1 Advertising imprint: pad printing on plastic
- K2 Advertising imprint: pad printing on metal
- S1 Advertising imprint: screen printing on bags
- S2 Advertising imprint: screen printing on umbrellas
- T1 Advertising imprint: transfer printing < 8 x 8 cm
- T2 Advertising imprint: transfer printing > 8 x 8 cm
- L1 Advertising imprint: laser engraving standard article ¹
- L2 Advertising imprint: laser engraving on metal

¹ Maximum lettering size: 7 sq. cm, larger engravings upon request



58-0400600
UM3, AA, 1,5V
60/600 piece



58-0400610
UM4, AAA, 1,5V
60/1200 piece

Information legend



Gift packed

This product is supplied in one of PiCOWORLD's stylish gift boxes.



Bigsize refill

The delivery of the product is included with a bigsize refill.



Alarm

This product is equipped with alarm.



Snooze

This product is equipped with snooze facility.



Clock Radio

Radio controlled clock. No separate manual adjustment required.



Worldtime

This product shows you the different time zones in selected countries.



Countdown timer

Define a time period and the countdown timer counts it down to zero.



Calendar

This product is equipped with a monthly calendar.



Date display

This product is equipped with an additional date display.



Weather information

The exact weather information is shown via the measurement of the air pressure.



Thermometer

Amongst other things, this product indicates the outside and interior temperature.



Hygrometer

The integrated hygrometer indicates the current room climate and the air humidity.



Normal flame

This lighter is equipped with a normal flame.



Point of glow

This lighter is equipped with a flame of point of glow.



Jet flame

The jet flame, or also laser flame, reaches a temperature of up to 1.300 °C.



Earphone

A suitable earphone is included.



Magnetic

This product is magnetically sealed.



Including battery

The matching battery is included.



Including button cell battery

The correct coin cell battery is included in delivery.



USB Connection

This product is equipped with a USB port.



Solar operation

This product draws its power via solar cells and is therefore particularly environmentally friendly.



White Light LED

Especially bright luminosity plus long service life and low energy consumption.



Removable rings

You can remove the different rings of this key ring or fob or chain.



Genuine leather

This product is manufactured from high-quality leather, breathable, water and air-permeable, light-resisting and sturdy.

INDEX

adapters.....	76-77, 81, 232	fleece items.....	333, 343-344, 394	plush animals.....	226, 393-402
air fresheners.....	209	folders.....	36-47, 49, 240, 244-245, 253, 258, 270, 434-440	pocket knives.....	118, 127-128, 168, 174, 324-327, 493-494, 521
air mattresses.....	365, 367	fondue sets.....	163	poker sets.....	373
air-pump.....	347	football items.....	140, 355, 368-369, 372, 381	portfolios.....	36-47, 49, 240, 244-245, 253, 258, 270, 434-440
alarm clocks.....	90-97, 99, 164, 443, 452, 455-456, 459	fountain pens.....	30-31, 417, 425	powerbanks.....	78-79, 447-450, 490
anti-stress balls.....	152, 212-213, 231, 379-381	fridges.....	137, 379	purses.....	63, 154-157, 489
aprons.....	194, 286, 321	games.....	192, 356-357, 360-362, 372-379,	radios.....	84, 86, 462, 464
ashtrays.....	204	382-384, 391, 528, 530-531	raincoats.....	345, 347
baking accessories.....	176-179, 182	gardening equipment.....	62, 314-315, 318-322	recyclable items.....	50, 52-53, 286-287
backpacks.....	241, 243, 251-265, 267, 277, 280,	garment bags.....	240, 246, 250	reflectors.....	10, 111-113, 115-116, 345, 351
.....	286-287, 336, 440, 486-487	gloves.....	116, 120, 176-178, 320-321, 328, 343-344, 370	rollerball pens.....	29-31, 416-417, 420-425
bag holders.....	66, 153	hammocks.....	322	rulers.....	54, 58, 65, 68-71, 387, 389
baggage.....	236-243, 246, 250-267, 272-277,	hand warmers.....	226, 490	safety vests.....	111, 116
.....	279-280, 440, 486-487, 499	hats.....	342-344	salt/pepper shakers.....	164-167, 518
baggage locks/scales.....	68, 246-247, 500-501	head lamps.....	108, 114, 352, 492	savings boxes.....	154
bags.....	36-47, 49, 115, 129, 240-289, 331, 333, 335,	head rests.....	233	scales.....	68, 176, 225, 501, 522
.....	337, 346, 349, 351, 371, 434-441, 486-488, 501	headwear.....	338-344	scarves.....	343-344, 350
ballpoint pens.....	12-13, 16-35, 50, 53, 67, 107,	health items.....	11, 41, 122-123, 212-223, 225,	screwdrivers.....	116-117, 124-126, 128-129, 131, 228, 324-327
.....	408, 410-413, 415-425, 430, 446	227, 230-233, 352-353, 502-503, 530	security items.....	10-11, 63, 111-113, 115-123,
balls.....	214, 354-355, 368-369, 379, 382-383	heart shaped items.....	22, 61, 113, 143, 153, 163, 177,	345, 351, 443, 488, 498-499
bar accessories.....	144, 184-195, 524-525	207, 212, 380, 385, 488, 511, 513, 517	self-adhesive labels.....	50-55, 59-60
barbecue accessories.....	182-183, 202-203, 328-337, 484-487	helicopter.....	373	selfie sticks.....	80-81
barbell.....	215	highlighters.....	24, 54-57	sewing kits.....	221, 230
bathroom accessories.....	11, 84, 122-123, 209, 212-213, 220-226,	hip flasks.....	195	shoe cleaning sets.....	231, 526
.....	230-232, 244, 247-251, 255, 276, 462, 501-503	hot-water bottles.....	402	shoppers.....	258, 267, 278-279, 282, 284-287, 289, 488
beach balls.....	368-369	household accessories.....	11, 68, 91, 95-98, 101, 120-123,	shopping cart chips.....	147, 507
beach items.....	150, 216, 276, 279, 314-315, 318, 356-371, 445	144-145, 160-211, 217, 219, 227, 229-231, 281,	shoulder bags.....	36, 41, 240, 244-245, 252-253, 255-258,
beach umbrellas.....	314-315, 318	286, 288-289, 334-337, 371, 457, 478, 481, 491, 514-526	261, 268-271, 282, 434, 437-439, 486
beauty cases.....	244, 247-251, 255, 276, 501	ice scrapers.....	11, 118, 120, 499	skipping rope.....	217, 377
belt pouch.....	115, 272, 351	inflatables.....	364-370	sleeping bags.....	323
bicycle equipment.....	86, 113, 266, 337, 345-349	jackets.....	345	smartphone accessories.....	34-35, 76-81, 85-86, 146, 232, 351,
Bluetooth accessories.....	80, 84-85, 462, 466-467, 469, 498	key rings/ lanyards.....	10-12, 17, 28, 66-67, 76, 111, 114, 131,	371, 408, 410, 447-451, 464-467, 469, 490, 498
bottle coolers.....	193, 524	134, 138-153, 155, 242-244, 361, 385, 393,	smoking accessories.....	202-204, 478, 481
bottle openers/caps.....	12, 127-128, 144-146, 148,	443, 446, 488, 504, 506-507, 509-513	soap bubble items.....	383
.....	189-194, 324-327, 481, 525	kitchen accessories.....	121, 144, 160-194, 196-201,	solar items.....	51, 62, 78-79, 147, 149, 216, 319,
bracelets.....	89, 112, 115, 151, 350-351, 382	286, 337, 371, 491, 514, 516-525	321, 449, 456, 472-473, 482
briefcases.....	41, 46-47, 240, 244-245, 271, 434, 438	kitchen knives.....	168-169, 172-175, 520-521	speakers.....	84-86, 464, 466-467, 498
business card holders.....	58, 64, 66-67, 152, 154, 431, 433	kites.....	356	sport accessories.....	115, 214-218, 252-254, 256-258, 266,
calculators.....	37, 43-44, 49, 51, 69-72, 428-429, 435-437	knives.....	118, 127-128, 168-169, 172-175,	272-275, 277, 324, 345-346, 349-355, 360, 371, 491, 530
cameras.....	149, 498	324-327, 493-494, 520-521	sport bags.....	252-254, 256-258, 272-275, 277, 280
camping items.....	61, 319, 323, 329, 331, 337, 371, 470, 492	lamps.....	10-11, 32, 63, 75, 104-110, 114-117, 125-126,	sticky notes.....	50-55, 59-60
candles.....	205-211	144-149, 151, 210-211, 218, 319, 321, 346-348,	suitcases.....	124, 126, 129, 236-244
caps.....	338-343	352, 412, 442, 444-445, 470, 472-477, 482, 492, 499, 510	sun glasses.....	359
car accessories.....	11, 76-77, 81, 116-123, 232-233,	laptop carry cases.....	36, 41, 45, 240, 244-245, 253-255,	tablet accessories.....	34-38, 40, 45, 76-81, 85-86, 146, 232, 255,
.....	314, 318, 348, 496, 498-499	258-262, 270, 434, 437-441	259-261, 408, 410, 440-441, 447-451, 464-467, 469, 490, 498
carrier bags.....	258, 267, 278-279, 281-282, 284-289, 371, 488	laser pointers.....	32-34	tape measures.....	131-135, 217, 495
cases.....	124, 126, 129, 236-244	leisure items.....	10, 61, 104-117, 125, 145-146, 182, 192,	tea accessories.....	160-163, 177, 517
ceramic knives.....	173, 520-521	195, 214-218, 266, 314-315, 318-324, 328-342, 345-379, 382,	tents.....	61, 319, 323-324, 337, 470, 492
chalk.....	384	384, 444-445, 470, 473-475, 484-487, 491-493, 528, 530-531	textiles.....	120, 194, 286, 321, 338-345, 350, 486
charging devices.....	78-79, 447-450, 475, 490, 496	lights.....	12, 202-204, 478, 481	thermo flasks.....	121, 196-201, 491
children's toys.....	225-226, 356-357, 360-361, 373, 375-379,	loudspeaker.....	84-86, 464, 466-467, 498	thermometers.....	91-92, 94-98, 101, 183, 189, 219, 226, 457
.....	382-385, 390-391, 393-402, 531	luggage.....	236-243, 246, 250-267, 272-277,	toilet bags.....	244, 247-251, 255, 276, 501
clocks.....	89-101, 140, 164, 443, 452, 454-461	279-280, 440, 486-487, 499	tools.....	105, 116-118, 124-135, 168, 174, 217,
cocktail accessories.....	189-195, 524	luggage locks/scales.....	68, 246-247, 500-501	228, 321, 324-327, 349, 493-495, 499, 521
coffee accessories.....	160-163, 177, 335, 517	magnets.....	61, 377	torches.....	10-11, 32, 104-107, 109-110,
coloured pencils.....	386-389, 391-392	magnifying glasses.....	60, 426	116-117, 125-126, 145-147, 472-475, 499
colouring sets.....	384, 386-392	manicure sets.....	220-223, 230, 502-503	touchscreen pens.....	12, 34-35, 77, 408, 410
compasses.....	61, 492	massage accessories.....	212-213, 231	toys.....	225-226, 354-357, 360-362, 368-370, 373,
computer equipment.....	32-34, 41, 45, 72-75, 77, 85-86, 255,	measuring tapes.....	131-135, 217, 495	375-379, 382-384, 391, 393-402, 531
.....	259-261, 441-446, 464-467, 476-477, 496, 498	memory stick.....	446	travel accessories.....	11, 38, 45, 58, 61, 63-64, 66-67, 75-81, 85,
cooler bags.....	266, 276, 281, 288-289, 331, 333, 335-337, 371	mobile phone accessories.....	34-35, 76-81, 85-86, 118, 146,	93-94, 104-107, 109, 116-125, 127-128, 145, 152, 154-155,
cosmetic accessories.....	220-224, 230, 244, 247-251,	232, 348, 351, 371, 408, 410, 447-451, 464-467, 469, 490, 498	196-201, 220-224, 230-233, 236-244, 246-251, 255, 259-261,
.....	255, 276, 501-503	mugs.....	121, 160-163, 177, 181, 195-200, 353, 491	266, 273, 276, 281, 288-289, 292-298, 314, 318, 324-325,
cosmetic bags/cases.....	244, 247-251, 255, 276, 501	multi-tools.....	127-128, 325, 493	335, 337, 348, 353-354, 371, 379, 431, 433, 441, 447-450,
cotton bags.....	286-287, 375	nordic walking.....	114, 216, 352-353, 492	452, 464-467, 474-476, 490-493, 496, 498-503, 526
crafting accessories.....	384-385	notebook carry cases.....	36, 38, 41, 45, 240, 244-245, 253-255,	travel adapters.....	76-77, 81, 232
crayons.....	386-389, 391-392	258-262, 270, 434, 437-439, 441	trolleys.....	236-243
credit card sleeve.....	63	nutcrackers.....	171, 523	umbrellas.....	292-313
cuddly toys.....	226, 393-402	office accessories.....	12-13, 16-61, 63-77, 152, 154, 240,	USB items.....	72-79, 84-86, 107, 441-450, 475-477, 490, 496
dental.....	121, 160-163, 177, 196-200, 491	244-245, 253, 258, 270-271, 358, 390, 393,	vacuum mugs/flasks.....	196-197, 199-201, 491
daily hygiene.....	222	408, 410-426, 428-446, 476-477, 496	waistcoats.....	111, 116
drawing accessories.....	26, 54, 65, 68-71, 386-390, 392	outdoor items.....	10, 61, 97, 104-118, 125, 127-128, 145-146,	wall clocks.....	99-101, 458-461
drinking bottles.....	324, 353-354, 371, 491	168, 182, 195, 216, 218, 266, 281, 288-289, 314-315,	wallets.....	63, 154-157, 489
earphones.....	87-89, 337, 467-469	318-342, 345-371, 470, 473-475, 484-487, 492-493, 499, 521	weather stations.....	91, 93, 95-98, 101, 457
egg timers.....	514, 516	pedometers.....	216	wellness items.....	209, 212-213, 218, 220-224,
executive cases.....	36, 41-42, 46-47, 240, 244-245,	pen holders.....	22-23, 25, 57, 59, 92-93, 411, 430	230-231, 233, 502-503
.....	253, 258, 270-271, 434, 437-439	pencil cases.....	386-387, 391-393	wine & accessories.....	184-194, 281, 524-525
eye masks.....	233	pencils.....	26, 28, 387, 389-390, 416, 422	winter clothing.....	343-344, 350
eyewear accessories.....	149, 228, 359, 527	pens.....	12-13, 16-32, 34-35, 50, 53-57, 67,	wooden toys.....	356, 372, 374-378, 385, 531
fans.....	75, 358, 444-445	386-392, 408, 410-413, 415-425, 446	writing sets.....	25, 28-32, 67, 411, 420-425
felt items.....	150, 154, 281-283, 378	photo frames.....	65, 76, 93, 454-455, 506	writing utensils.....	12-13, 16-32, 34-35, 43-44, 50, 53,
first aid kits.....	11, 122-123, 227	picnic accessories.....	276, 281, 288-289, 329, 331,	67, 107, 390, 408, 410-413, 415-425, 446
fitness items.....	115, 214-218, 252-254, 256-258, 272-275,	333-337, 371, 486-487		
.....	277, 324, 345-347, 349-355, 371, 491, 530	pill boxes.....	232		

Colours and layouts in the catalogue may differ from the original. Prices, misprints and technical specifications are subject to change. All products are sold without any decoration.